

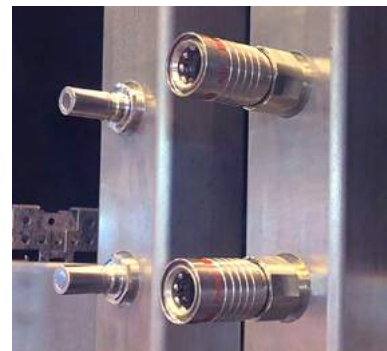

Quick Coupling Products

Quick Couplings, Swivels, Valves,
Diagnostic Sensors and Equipment
Catalog 3800 USA | February 2022



ENGINEERING YOUR SUCCESS.

Quick Coupling Division Locations



Minneapolis, MN



Grantsburg, WI



Chetek, WI



Union City, PA

WARNING

FAILURE OR IMPROPER SELECTION OR IMPROPER USE OF THE PRODUCTS DESCRIBED HEREIN OR RELATED ITEMS CAN CAUSE DEATH, PERSONAL INJURY AND PROPERTY DAMAGE.

- This document and other information from Parker-Hannifin Corporation, its subsidiaries and authorized distributors provide product or system options for further investigation by users having technical expertise.
- The user, through its own analysis and testing, is solely responsible for making the final selection of the system and components and assuring that all performance, endurance, maintenance, safety and warning requirements of the application are met. The user must analyze all aspects of the application, follow applicable industry standards, and follow the information concerning the product in the current product catalog and in any other materials provided from Parker or its subsidiaries or authorized distributors.
- To the extent that Parker or its subsidiaries or authorized distributors provide component or system options based upon data or specifications provided by the user, the user is responsible for determining that such data and specifications are suitable and sufficient for all applications and reasonably foreseeable uses of the components or systems.

Offer of Sale

The items described in this document are hereby offered for sale by Parker Hannifin Corporation, its subsidiaries or its authorized distributors. This offer and its acceptance are governed by the provisions stated in the "Offer of Sale."



Table of Contents

Pneumatic Quick Couplings

Introduction	A-1
Coupling Selection & Ordering Guide	A-3
Interchange Match-up Chart	A-5
General Purpose Couplings	
Industrial Interchange Nipples.....	A-6
20 Series	A-9
30 Series.....	A-12
Rectus 21, 23, 30 Series	A-15
(formerly HF Series)	
Tru-Flate Design, Automotive Interchange	
10 Series.....	A-18
ARO 210 Interchange	
50 Series.....	A-22
Universal Coupler (accepts Industrial Interchange,	
Tru-Flate, and 50 Series Nipples)	
UC Series.....	A-25
Lincoln “Long Stem” Interchange	
70 Series.....	A-26
European High Flow Interface	
Rectus 25 Series	A-28
(formerly RF Series)	
Schrader Twist-Lock Interchange	
TL Series	A-31
Snap-tite Design	
IH Series	A-34

Special Purpose Couplings

Tool-Mate Series (Non-Marring)	
Rectus 25 and Industrial Interchange Styles.....	A-36
Tool-Mate Series (Non-Marring, Exhaust)	
Rectus 25 and Industrial Interchange Styles.....	A-38
E-z-mate Series (Exhaust)	
Industrial Interchange	A-40
GF Series	
Natural & Propane Gas	A-42

Hydraulic Quick Couplings

Introduction	B-1
Coupling Selection & Ordering Guide	B-4, 5, 98
General Purpose Couplings	
60 Series	B-6
Couplers.....	B-8
Nipples	B-9
60 Series Steam	B-12
Couplers.....	B-12
Nipples	B-12
6600 Series	B-13
Couplers.....	B-14
Nipples	B-14
H & PH Series.....	B-16
H Couplers	B-19
H Nipples	B-22
PH Couplers.....	B-21
PH Nipples	B-23
EA Series	B-26
Couplers.....	B-28
Nipples	B-29
SM Series.....	B-30
Couplers.....	B-31
Nipples	B-31
HP Series.....	B-33
Couplers.....	B-34
Nipples	B-34
4000 Series	B-35
Couplers.....	B-36
Nipples	B-36
4200 Series	B-38
Couplers.....	B-39
Nipples	B-39
Non-Spill Couplings	
NS Series.....	B-40
Couplers.....	B-41
Nipples	B-41
NSS Series.....	B-42
Couplers.....	B-43
Nipples	B-44

* UC Series is a replacement for the HA Series.



Table of Contents

FF/FC Series.....	B-46	1163 Series	B-88
Couplers.....	B-47	Couplers	B-88
Nipples.....	B-47	Nipples.....	B-88
FC Nipples.....	B-49	HO Series	B-89
FEM/FEC Series.....	B-50	Couplers	B-89
Couplers	B-51	Nipples.....	B-89
Nipples.....	B-52	Mold Coolant Line Couplings	
FEC Nipples.....	B-53	Moldmate Series.....	B-90
FH Series.....	B-54	Couplers	B-91
Couplers	B-55	Sub Assemblies & Replacement Parts.....	B-92
Nipples.....	B-55	Nipples.....	B-94
FS Series	B-56	Miniature	
Couplers	B-57	DM Series.....	B-96
Nipples.....	B-57	Couplers	B-97
		Nipples.....	B-97
Connect Under Pressure Couplings		SensoControl Diagnostic and Industrial Catalogs.....	B-99
59 Series	B-59	Diagnostic Test Port Couplings	B-99
Couplers.....	B-60	Test Port Couplings	B-100
Nipples.....	B-60	PD Series	B-100
FET Series.....	B-61	Dust Cap	B-100
Couplers.....	B-62	Couplers	B-101
Nipples.....	B-63	Nipples.....	B-101
6100 Series.....	B-65	PDP Series	B-104
Couplers	B-66	Dust Cap	B-104
Nipples.....	B-67	Couplers	B-105
8200 Series.....	B-68	Nipples.....	B-105
Couplers	B-69	EMA3 Series.....	B-106
Nipples.....	B-69	Nipples.....	B-107
9200 Series.....	B-70	Gauge Adapters & Union.....	B-107
Couplers	B-71	Transducer Adapters.....	B-108
Nipples.....	B-71	Flexible Hose	B-108
5000 Series.....	B-72	PDFS Series - Fluid Sampling.....	B-109
Couplers	B-73	Couplers	B-109
Nipples.....	B-73	Nipples.....	B-109
75 Series	B-74	Probe	B-109
Couplers.....	B-76	Promotional Products-Keychains	B-111
Nipples.....	B-76		
High Pressure Couplings		Thermoplastic Quick Couplings	
71 Series	B-77	Coupling Selection Guide	C-2
Couplers.....	B-79	Spectrum Series.....	C-3
Nipples.....	B-80	Couplers	C-4, C-5
3000 Series.....	B-81	Nipples.....	C-5
Couplers	B-82	Swivels	
Nipples.....	B-82	PS Series	
TC Series.....	B-83	Introduction	D-2
Couplers	B-83	Seal Options	D-2
Nipples.....	B-83	How To Order	D-4
1141 Series.....	B-84	Repair Kits	D-4
Couplers	B-84	In-Line.....	D-5
Nipples.....	B-84	90°	D-8
High Flow Couplings			
ST Series	B-85		
Couplers	B-86		
Nipples.....	B-87		

Table of Contents

S Series

Introduction	D-13
Repair Kits	D-13
How To Order	D-14
90°	D-15

Valves

Introduction	E-1
---------------------------	-----

Check Valves

Selection Guide & General Technical Information	E-3
DT Series.....	E-4
Ordering Information	E-8
CV Series.....	E-9
Ordering Information	E-11
DC Series	E-12
Ordering Information	E-13
CPIFF Series (soft seat).....	E-14
S6C Series (soft seat).....	E-15
3C Series (soft seat).....	E-15
2600 Series (swing type).....	E-17

Pressure/Vacuum Relief Valves

H1 & HM1 Series	E-18
Ordering Information	E-18
PV Series.....	E-19
Ordering Information	E-19

Thermal Bypass Valves

TH Series	E-20
Ordering Information	E-21

Appendices

Fluid Compatibility Chart	I
Part Number Index	VII
Safety Guide	XIX
Offer of Sale	XXI
Glossary of Terms	XXII



Pneumatic Quick Couplings

Single Shut-Off Couplings

Single Shut-Off couplings are primarily used for pneumatic applications, connecting air tools, hoses, or other implements to compressed air supplies. They are also used with other gases, and with the exception of the E-z-mate Series can be used with low pressure fluids. The coupler half contains a shut-off valve that is automatically opened when a mating nipple is inserted and automatically closes when the nipple is removed.

Parker Single Shut-Off couplings come in three basic designs: general purpose/manual connect, general purpose/push-to-connect, and special purpose.

The standard seal material for all Parker Single Shut-Off couplers is Nitrile. Ethylene Propylene, Fluorocarbon, and Neoprene seals are available as options. See the comprehensive Fluid Compatibility Chart that provides guidelines for seal and body material selection. When there is need for further assistance in selecting the appropriate seal material, please consult the Quick Coupling Division.

General Ordering Information

When ordering Parker coupler bodies and nipples, please state the part number of each type of coupler body and each type of nipple desired. List coupler bodies and nipples as separate items rather than in combinations. Be sure to double check thread or hose sizes of items required.

Many of Parker's coupling products are available with unique non-standard options well suited to very specific applications. Examples of unusual end use applications might include: high temperatures (above 250° F), extremely caustic/corrosive solutions passing through the coupling, external/environmental corrosion situations, or other high wear and tear situations such as dragging the product along the ground. It is always recommended that the Quick Coupling Division be contacted with any questions concerning specific product application needs.

Checklist for Selecting Quick Couplings

- What are the functional requirements of the coupling?
- What is the maximum working pressure of the application?
- Which seals and body material are compatible with the system's fluid?
- Is the application static or dynamic?
- What size coupler/hose is required?
- What is the maximum pressure drop suitable for the application?
- Does the application require the ability to connect and disconnect under pressure?
- What is the media temperature and ambient temperature?
- What end configurations are required?
- Is an industry interchange coupler required?
- Is air inclusion and fluid loss a concern in the application?

Table of Contents

Introduction	A-1
Coupling Selection & Ordering Guide	A-3
Interchange Match-up Chart	A-5
General Purpose Couplings	
Industrial Interchange Nipples.....	A-6
20 Series	A-9
30 Series.....	A-12
Rectus 21, 23, 30 Series	A-15
(formerly HF Series)	
Tru-Flate Design, Automotive Interchange	
10 Series.....	A-18
ARO 210 Interchange	
50 Series.....	A-22
Universal Coupler (accepts Industrial Interchange, Tru-Flate, and 50 Series Nipples)	
UC Series.....	A-25
Lincoln "Long Stem" Interchange	
70 Series.....	A-26
European High Flow Interface	
Rectus 25 Series	A-28
(formerly RF Series)	
Schrader Twist-Lock Interchange	
TL Series	A-31
Snap-tite Design	
IH Series	A-34
Special Purpose Couplings	
Tool-Mate Series (Non-Marring)	
Rectus 25 and Industrial Interchange Styles.....	A-36
Tool-Mate Series (Non-Marring, Exhaust)	
Rectus 25 and Industrial Interchange Styles.....	A-38
E-z-mate Series (Exhaust)	
Industrial Interchange	A-40
GF Series	
Natural & Propane Gas	A-42

Pneumatic Coupling Selection Guide

Pneumatic Coupling Selection Guide (by Interchange)										
Body Sizes (in.)	Connection style	Material*				Locking Mechanism	Std Seal Material	Std Seal Temp Range	Rated Pressure	Coupler Series
Industrial Interchange Couplers										
General Purpose										
1/4 to 1/2	Manual Sleeve	■	■	■		Ball	Nitrile	-40° to +250° F	300 psi	20 Series
1/8 to 3/8	Push-to-Connect	■	■			Ball	Nitrile	-40° to +250° F	300 psi	Rectus 21, 32, 30 Series
1/4 to 3/4	Push-to-Connect	■				Pawl	Nitrile	-40° to +250° F	300 psi	30 Series
1/4	Push-to-Connect	■				Ball	Nitrile	-40° to +250° F	150 psi	Universal Series
Special Purpose										
1/4 & 3/8	Push-to-Connect		■		■	Fingers	Nitrile	-40° to +250° F	300 psi	Tool-Mate (PBH) (non-marring)
1/4 to 1/2	Push-to-Connect		■		■	Fingers	Nitrile	-40° to +250° F	300 psi	Tool-Mate (PBS) (non-marring, exhaust)
1/4 to 3/4	Push-to-Connect		■			Ball	Nitrile	-40° to +250° F	300 psi	E-z-mate (exhaust)
Tru-Flate Interchange Couplings										
1/4 to 1/2	Manual Sleeve	■	■			Ball	Nitrile	-40° to +250° F	300 psi	10 Series
1/4	Push-to-Connect	■				Ball	Nitrile	-40° to +250° F	150 psi	Universal Series
ARO 210 Interchange Couplings										
1/4	Manual Sleeve	■	■			Ball	Nitrile	-40° to +250° F	300 psi	50 Series
1/4	Push-to-Connect	■				Ball	Nitrile	-40° to +250° F	150 psi	Universal Series
Lincoln "Long Stem" Interchange Couplings										
1/4	Manual Sleeve	■				Ball	Nitrile	-40° to +250° F	300 psi	70 Series
Common High-Flow European Interchange Couplings										
1/4	Push-to-Connect	■	■			Ball	Nitrile	-40° to +250° F	300 psi	Rectus 25 Series
1/4	Push-to-Connect		■		■	Fingers	Nitrile	-40° to +250° F	300 psi	Tool-Mate (PER) (non-marring)
1/4	Push-to-Connect		■		■	Fingers	Nitrile	-40° to +250° F	300 psi	Tool-Mate (PES) (non-marring, exhaust)
Schrader Twist -Lock Interchange Couplings										
1/4 & 1/2	Push-to-Connect	■	■			Cam	Nitrile	-40° to +250° F	300 psi	TL Series

Continued on next page

* Material Code: B = Brass, S = Steel, SS = Stainless Steel, P = Plastic

Optional Materials and Features:

(add code to part number)

Contact QCD for availability and additional options.

To select proper seal materials, see Fluid Compatibility Chart or contact QCD.

Code	Description	Applies to
prefix B	Brass body	Nipples (std is steel) Couplers (3/8" & 1/2" sizes only)
suffix N	Stainless steel springs, locking balls & brass valves	Couplers (10, 20, 30, 50 & 70 Series)
suffix -SL	Sleeve-Lok	Couplers (10, 20, 30, 50 & 70 Series)
suffix R	Grip Ring sleeve	Couplers (10 & 20 Series)
suffix W	Ethylene Propylene seal material (-65° to + 400° F)	Couplers
suffix Y	Fluorocarbon seal material (-30° to + 400° F)	Couplers



WARNING: This product can expose you to chemicals including Lead, which is known to the State of California to cause cancer and birth defects or other reproductive harm. For more information go to www.P65Warnings.ca.gov



Pneumatic Coupling Selection Guide - continued

A Pneumatics

Pneumatic Coupling Selection Guide										
Body Sizes (in.)	Connection style	Material*				Locking Mechanism	Std Seal Material	Std Seal Temp Range	Rated Pressure	Coupler Series
Special Purpose - Natural and Propane Gas Couplings										
1/4 to 1-1/4	Manual Sleeve	■				Ball	Fluorocarbon	32° to +200° F	60 psi max	GF Series
Thermoplastic Couplings										
1/8 & 3/8	Push-to-Connect				■**	Finger Lock	Nitrile or Fluorocarbon	0° to +180° F 0° to +250° F	Vacuum to 145 psi	Spectrum Series

* Material Code: B = Brass, S = Steel, SS = Stainless Steel, P = Plastic

**** Spectrum Series material options:**

- Acetal/316SS
- PVDF/316SS (subject to quote from the division)
- PVDF/PEEK™ (subject to quote from the division)



WARNING: This product can expose you to chemicals including Lead, which is known to the State of California to cause cancer and birth defects or other reproductive harm. For more information go to www.P65Warnings.ca.gov

Popular Coupling Designs

Parker's Quick Coupling Division manufactures quick couplings to interchange with popular designs that have become accepted standards in the industry today. The actual size nipple chart below can be used to help select Parker Quick Couplings that will interchange with specific nipple designs and sizes.

10 Series

(Tru-Flate Automotive Interchange)

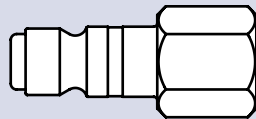

1/4" Body Size

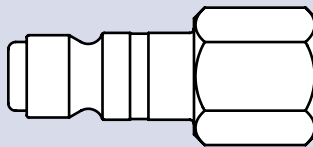

3/8" Body Size

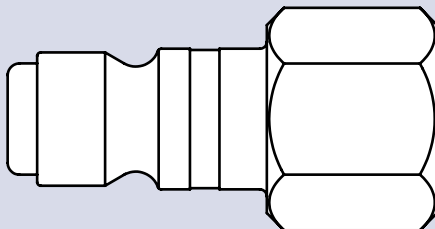

1/2" Body Size

**20 Series, 30 Series, HF Series,
E-z-mate** (Industrial Interchange)

1/8" HF Series

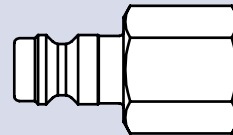

1/8" Body Size

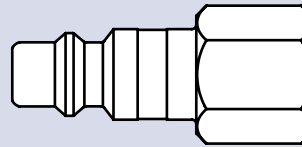

1/4" Body Size

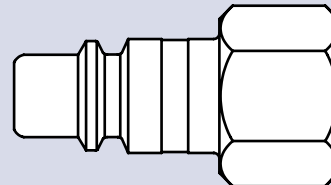

3/8" Body Size

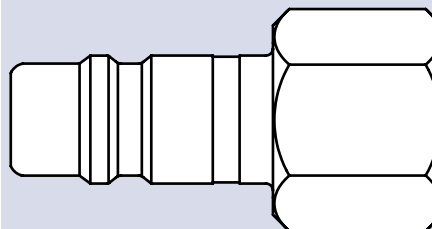

1/2" Body Size

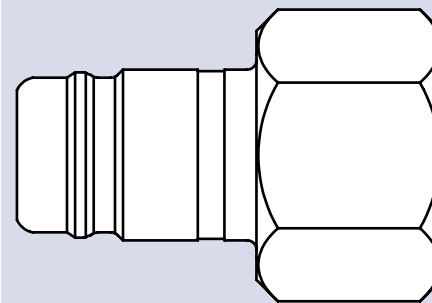

3/4" Body Size

50 Series (ARO-210 Interchange)

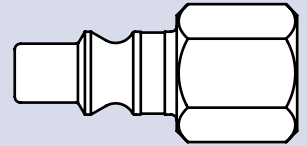

1/4" Body Size

70 Series (Lincoln Interchange)

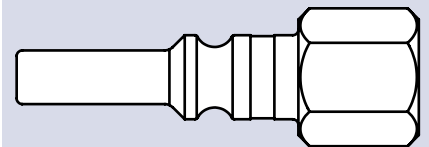

1/4" Body Size

Twist-Lock (Schrader Interchange)

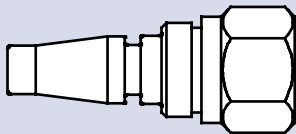

1/4" Body Size

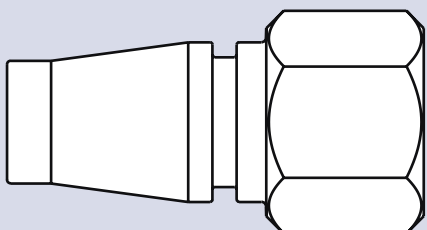

1/2" Body Size

Rectus 25 Series
(European Interchange)

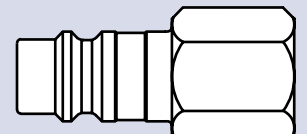

1/4" Body Size

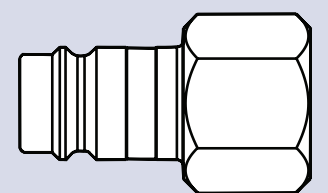

3/8" Body Size



WARNING: This product can expose you to chemicals including Lead, which is known to the State of California to cause cancer and birth defects or other reproductive harm. For more information go to www.P65Warnings.ca.gov

Pneumatic Quick Couplings

General Purpose

Industrial Interchange Nipples

A-A-59439, MIL- C-4109F Design

Non-valved, straight through



A Pneumatics



Parker Industrial Interchange Nipples are compatible for use with 20 Series, 30 Series, HF Series, Universal or E-z-mate couplers. The standard male tip of the pneumatic industry, these nipples are interchangeable with similar nipples manufactured to the same requirements.

Features:

- Conforms to A-A-59439 (MIL-C-4109F, ISO 6150-B) requirements for global interchangeability
- Steel nipples have hardened wear points and load-bearing areas
- Unvalved style nipple mates with valved couplers

Applications include:

- Air compressors
- Pneumatic tools
- Drop-down air lines

Optional Material:

(add code to part number)

Code	Description	Part Number Example
prefix B	Brass body	BH1E

Contact QCD for availability and additional options.

Nipples - Female Pipe Thread



Body Size	Part Number Brass	Part Number Steel	Part Number Stainless Steel (303) **	Thread Size	Length	Exposed Length*	Largest Diameter	Wrench Flats	Weight (lbs.)
1/4	-	H1C	-	1/8-27 NPTF	1.48	0.71	0.58	0.50	0.03
1/4	BH3C	H3C	SH3C	1/4-18 NPTF	1.56	0.80	0.72	0.62	0.05
1/4	-	H3C-E	SH3C-E	3/8-18 NPTF	1.60	0.83	0.94	0.81	0.08
3/8	-	H1E	-	1/4-18 NPTF	1.60	0.69	0.72	0.62	0.06
3/8	BH3E	H3E	-	3/8-18 NPTF	1.72	0.74	0.94	0.81	0.10
3/8	-	H3E-F	-	1/2-14 NPTF	1.89	0.90	1.16	1.00	0.13
1/2	-	H1F	-	3/8-18 NPTF	2.03	0.79	0.94	0.81	0.12
1/2	BH3F	H3F	-	1/2-14 NPTF	2.20	0.83	1.16	1.00	0.19
1/2	-	H3F-G	-	3/4-14 NPTF	2.30	1.05	1.44	1.25	0.26
3/4	-	H3G-F	-	1/2-14 NPTF	2.22	1.06	1.16	1.00	0.23
3/4	-	H3G	-	3/4-14 NPTF	2.18	1.02	1.44	1.25	0.34
3/4	-	H3G-J	-	1-11 1/2 NPTF	2.41	1.25	1.80	1.63	0.47

* This dimension represents the portion of the nipple that is exposed when the nipple is connected to a Parker 20 Series coupler.

**Prop 65 Warning does not apply to stainless steel part numbers.



WARNING: This product can expose you to chemicals including Lead, which is known to the State of California to cause cancer and birth defects or other reproductive harm. For more information go to www.P65Warnings.ca.gov





Nipples - Male Pipe Thread



Body Size	Part Number Brass	Part Number Steel	Part Number Stainless Steel (303)**	Thread Size	Length	Exposed Length*	Largest Diameter	Wrench Flats	Weight (lbs.)
1/4	-	H0C	-	1/8-27 NPTF	1.68	0.92	0.58	0.50	0.05
1/4	BH2C	H2C	SH2C	1/4-18 NPTF	1.66	0.89	0.65	0.56	0.06
1/4	-	H2C-E	SH2C-E	3/8-18 NPTF	1.90	1.14	0.80	0.69	0.07
3/8	-	H00E	-	1/8-27 NPTF	1.68	0.73	0.72	0.62	0.08
3/8	-	H0E	-	1/4-18 NPTF	1.90	0.95	0.72	0.62	0.08
3/8	BH2E	H2E	-	3/8-18 NPTF	1.90	0.95	0.80	0.69	0.09
3/8	-	H2E-F	-	1/2-14 NPTF	2.03	1.09	1.02	0.88	0.15
1/2	-	H0F	-	3/8-18 NPTF	2.20	0.96	0.79	0.69	0.16
1/2	BH2F	H2F	-	1/2-14 NPTF	2.35	1.09	1.01	0.88	0.18
1/2	-	H2F-G	-	3/4-14 NPTF	2.40	1.16	1.22	1.06	0.24
3/4	-	H2G-F	-	1/2-14 NPTF	2.32	1.16	1.16	1.00	0.22
3/4	BH2G	H2G	-	3/4-14 NPTF	2.28	1.12	1.22	1.06	0.28
3/4	-	H2G-J	-	1-11 1/2 NPTF	2.56	1.40	1.52	1.31	0.36

Nipples - Standard Hose Barb



Body Size	Part Number Brass	Part Number Steel	Part Number Stainless Steel (303) **	Hose I.D.	Length	Exposed Length*	Largest Diameter	Weight (lbs.)
1/4	-	H8C	-	1/4	1.72	0.95	0.46	0.04
1/4	-	-	SH8C	1/4	2.09	1.33	0.56	0.04
1/4	-	H8C-D	-	5/16	1.96	1.20	0.50	0.04
1/4	-	H9C	SH9C	3/8	1.96	1.20	0.50	0.05
3/8	-	H5E	-	3/8	1.85	0.90	0.59	0.07
3/8	-	H6E	-	1/2	2.09	1.14	0.68	0.08
1/2	-	H4F	-	3/8	2.36	1.12	0.66	0.10
1/2	-	H5F	-	1/2	2.36	1.12	0.66	0.11
1/2	-	H5F-G	-	3/4	2.95	1.71	0.87	0.18
3/4	-	H5G-F	-	1/2	2.47	1.31	0.93	0.19
3/4	BH5G	H5G	-	3/4	3.00	1.84	0.93	0.25
3/4	-	H5G-J	-	1	3.24	2.08	1.24	0.36

* This dimension represents the portion of the nipple that is exposed when the nipple is connected to a Parker 20 Series coupler.
**Prop 65 Warning does not apply to stainless steel part numbers.

WARNING: This product can expose you to chemicals including Lead, which is known to the State of California to cause cancer and birth defects or other reproductive harm. For more information go to www.P65Warnings.ca.gov



Nipples - Push-Lok Hose Barb**



Body Size	Part Number Brass	Part Number Steel	Hose I.D.	Length	Exposed Length*	Largest Diameter	Weight (lbs.)
1/4	BH8CP	H8CP	1/4	1.74	0.97	0.69	0.04
1/4	-	H9CP	3/8	1.96	1.19	0.86	0.05
3/8	-	H4EP	1/4	1.87	0.92	0.69	0.06
3/8	-	H5EP	3/8	2.02	1.07	0.86	0.07
3/8	-	H6EP	1/2	2.21	1.27	0.97	0.09
1/2	-	H4FP	3/8	2.36	1.11	0.86	0.11
1/2	-	H5FP	1/2	2.48	1.24	0.97	0.11
1/2	-	H6FP	5/8	2.95	1.71	1.14	0.14

* This dimension represents the portion of the nipple that is exposed when the nipple is connected to a Parker 20 Series coupler.

**Push-Lok hose barbs are designed for use with Parker Push-Lok hose and do not require clamps.



WARNING: This product can expose you to chemicals including Lead, which is known to the State of California to cause cancer and birth defects or other reproductive harm. For more information go to www.P65Warnings.ca.gov



20 Series Pneumatic Couplers mate with Industrial Interchange nipples, the standard male tip of the pneumatic industry. Available options include Sleeve-Lok, stainless steel locking balls and springs, and grip-ring sleeve.

Features:

- Mates with Industrial Interchange nipples manufactured to A-A-59439 (MIL-C-4109F, ISO 6150-B) global standards
- 1/4" body size has a brass body and steel valve, 3/8" body size has all steel construction
- Tubular valve delivers high flow with minimal pressure drop
- Integral sleeve guard resists accidental disconnection
- Standard seal is Nitrile

Applications:

- Air compressors
- Pneumatic tools
- Water
- Grease
- Paint

Performance

20 Series (1/4", 3/8", 1/2" sizes)

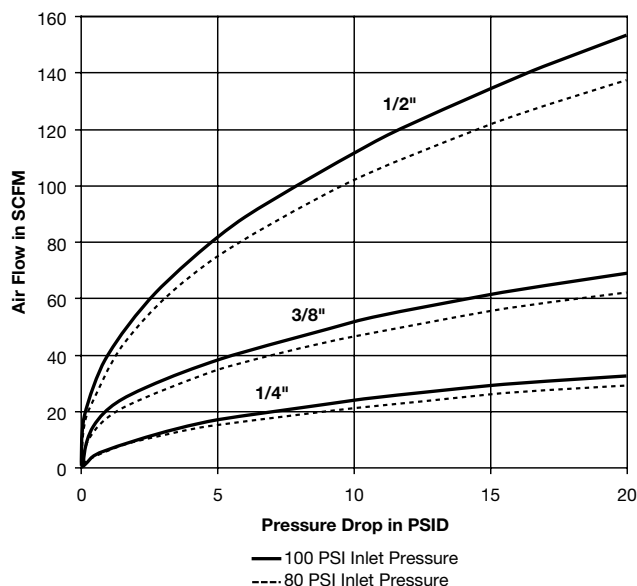

20 Series Specifications

Body Size	1/4	3/8	1/2
Rated Pressure (psi)	300		
Temperature Range (std seals)	-40° to +250° F		
Locking Device	4 balls	8 balls	8 balls
Vacuum Data (in. Hg.)	-		
Disconnected (coupler only)	Not Recommended		
Connected	27.4		

Repair Kits

Body Size	Seal Material	Part No.
1/4	Nitrile	21K
1/4	Ethylene Propylene	21KW
1/4	Fluorocarbon	21KY
3/8	Nitrile	14K
3/8	Ethylene Propylene	14KW
3/8	Fluorocarbon	14KY
1/2	Nitrile	16K
1/2	Ethylene Propylene	16KW
1/2	Fluorocarbon	16KY
3/4	Nitrile	38K
3/4	Ethylene Propylene	38KW
3/4	Fluorocarbon	38KY



Couplers - Female Pipe Thread



Body Size	Part Number Brass	Part Number Steel	Part Number Stainless Steel (303) **	Thread Size	Length	Largest Diameter	Wrench Flats	Weight (lbs.)
1/4	B23A	-	-	1/8-27 NPTF	1.83	0.90	0.75	0.20
1/4	B23	-	S23	1/4-18 NPTF	1.83	0.90	0.75	0.19
1/4	B23E	-	-	3/8-18 NPTF	1.95	0.94	0.81	0.20
3/8	-	25C	-	1/4-18 NPTF	2.22	1.06	0.88	0.30
3/8	B25	25	-	3/8-18 NPTF	2.28	1.06	0.88	0.32
3/8	-	25F	-	1/2-14 NPTF	2.55	1.16	1.00	0.34
1/2	-	17E	-	3/8-18 NPTF	2.74	1.19	1.00	0.46
1/2	B17	17	-	1/2-14 NPTF	2.96	1.19	1.00	0.50
1/2	-	17G	-	3/4-14 NPTF	3.19	1.44	1.25	0.56

Couplers - Male Pipe Thread



Body Size	Part Number Brass	Part Number Steel	Part Number Stainless Steel (303) **	Thread Size	Length	Largest Diameter	Wrench Flats	Weight (lbs.)
1/4	B22A	-	-	1/8-27 NPTF	1.89	0.90	0.75	0.18
1/4	B22	-	S22	1/4-18 NPTF	2.05	0.90	0.75	0.18
1/4	B22E	-	-	3/8-18 NPTF	2.08	0.90	0.75	0.19
3/8	-	24C	-	1/4-18 NPTF	2.36	1.06	0.88	0.26
3/8	B24	24	-	3/8-18 NPTF	2.39	1.06	0.88	0.29
3/8	-	24F	-	1/2-14 NPTF	2.55	1.16	0.88	0.29
1/2	-	16E	-	3/8-18 NPTF	2.93	1.19	1.00	0.42
1/2	B16 *	16	-	1/2-14 NPTF	3.08	1.19	1.00	0.47
1/2	-	16G	-	3/4-14 NPTF	3.21	1.30	1.13	0.56

* Coupler has brass body and steel sleeve.

** Prop 65 Warning does not apply to stainless steel part numbers.

Optional Materials and Features:

(add code to part number)

Code	Description	Part Number Example
prefix B	Brass body (Couplers - 3/8" & 1/2" sizes only)	B24C
suffix N	Stainless steel springs, locking balls & brass valves (Couplers)	B24N
suffix -SL	Sleeve-Lok (Couplers)	24-SL
suffix R	Grip Ring sleeve (Couplers)	24R
suffix W	Ethylene Propylene seal material (-65° to + 400° F) (Couplers)	24W
suffix Y	Fluorocarbon seal material (-30° to + 400° F) (Couplers)	24Y

Contact QCD for availability and additional options.

To select proper seal materials, see Fluid Compatibility Chart or contact QCD.



WARNING: This product can expose you to chemicals including Lead, which is known to the State of California to cause cancer and birth defects or other reproductive harm. For more information go to www.P65Warnings.ca.gov



Couplers - Standard Hose Barb



Body Size	Part No. Brass	Part No. Steel	Hose I.D.	Length	Largest Diameter	Wrench Flats	Weight (lbs.)
1/4	B20-3B	-	1/4	2.49	0.90	0.75	0.18
1/4	B20-4B	-	5/16	2.49	0.90	0.75	0.18
1/4	B20-5B	-	3/8	2.49	0.90	0.75	0.18
3/8	-	24-5B	3/8	2.60	1.06	0.88	0.27
3/8	-	24-6B	1/2	2.60	1.06	0.88	0.28
1/2	-	16-5B	3/8	3.14	1.19	1.00	0.41
1/2	-	16-6B	1/2	3.14	1.19	1.00	0.43
1/2	-	16-7B	3/4	3.60	1.19	1.00	0.48

Couplers - Push-Lok Hose Barb*



Body Size	Part No. Brass	Part No. Steel	Hose I.D.	Length	Largest Diameter	Wrench Flats	Weight (lbs.)
1/4	B20-3BP	-	1/4	2.32	0.90	0.75	0.18
1/4	B20-5BP	-	3/8	2.47	0.90	0.75	0.19
3/8	-	24-5BP	3/8	2.88	1.06	0.88	0.27
1/2	-	16-5BP	3/8	3.35	1.19	1.00	0.41
1/2	-	16-6BP	1/2	3.46	1.19	1.00	0.43

* Push-Lok hose barbs are designed for use with Parker Push-Lok hose and do not require clamps.

NOTE: See Table of Contents for pneumatic Industrial Interchange nipples used with 20 Series couplers.



WARNING: This product can expose you to chemicals including Lead, which is known to the State of California to cause cancer and birth defects or other reproductive harm. For more information go to www.P65Warnings.ca.gov

Pneumatic Quick Couplings - General Purpose

30 Series Couplers Accepts Industrial Interchange Nipples

Push-to-connect sleeve, single shut off



30 Series Pneumatic Couplers mate with Industrial Interchange nipples, the standard male tip of the pneumatic industry. The couplers have brass bodies. Standard seal is Nitrile.

Features:

- Mates with Industrial Interchange nipples manufactured to A-A-59439 (MIL-C-4109F, ISO 6150-B) global standards
- Tubular valve delivers high flow with minimal pressure drop
- Push-to-connect operation
- Options include Sleeve-Lok, brass valve for added corrosion resistance, and alternative seal materials

Applications include:

- Air compressors
- Pneumatic tools
- Water
- Grease
- Paint



Performance

30 Series (1/4" & 3/8" sizes)

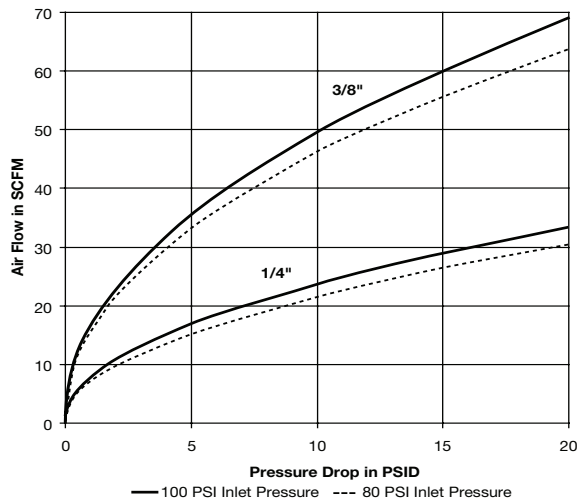

30 Series (1/2" & 3/4" sizes)

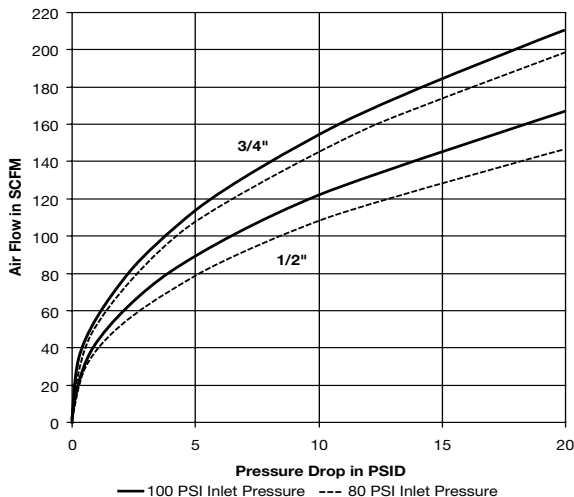

30 Series Specifications

Body Size	1/4	3/8	1/2	3/4
Rated Pressure (psi)	300			
Temperature Range (std seals)	-40° to +250° F			
Locking Device	3 pawls	3 pawls	6 pawls	6 pawls
Vacuum Data (in. Hg.)	—			
Disconnected (coupler only)	Not Recommended			
Connected	27.4			

Repair Kits

Body Size	Seal Material	Part No.
1/4	Nitrile	21K
1/4	Ethylene Propylene	21KW
1/4	Fluorocarbon	21KY
3/8	Nitrile	14K
3/8	Ethylene Propylene	14KW
3/8	Fluorocarbon	14KY
1/2	Nitrile	16K
1/2	Ethylene Propylene	16KW
1/2	Fluorocarbon	16KY
3/4	Nitrile	38K
3/4	Ethylene Propylene	38KW
3/4	Fluorocarbon	38KY



Couplers - Female Pipe Thread



Body Size	Part No. Brass	Thread Size	Length	Largest Diameter	Wrench Flats	Weight (lbs)
1/4	B33A	1/8-27 NPTF	1.96	1.20	0.75	0.30
1/4	B33	1/4-18 NPTF	1.96	1.20	0.75	0.28
1/4	B33E	3/8-18 NPTF	2.03	1.20	0.81	0.30
3/8	B35C	1/4-18 NPTF	2.26	1.39	0.88	0.42
3/8	B35	3/8-18 NPTF	2.33	1.39	0.88	0.42
3/8	B35F	1/2-14 NPTF	2.57	1.39	1.00	0.46
1/2	B37E	3/8-18 NPTF	2.76	1.52	1.00	0.56
1/2	B37	1/2-14 NPTF	3.00	1.52	1.00	0.66
1/2	B37G	3/4-14 NPTF	3.12	1.52	1.25	0.73
3/4	B39F	1/2-14 NPTF	2.85	1.90	1.31	0.15
3/4	B39	3/4-14 NPTF	2.99	1.90	1.31	1.10
3/4	B39J	1-11 1/2 NPTF	3.18	1.90	1.63	1.24

Couplers - Male Pipe Thread



Body Size	Part No. Brass	Thread Size	Length	Largest Diameter	Wrench Flats	Weight (lbs)
1/4	B32A	1/8-27 NPTF	2.03	1.20	0.75	0.27
1/4	B32	1/4-18 NPTF	2.18	1.20	0.75	0.28
1/4	B32E	3/8-18 NPTF	2.18	1.20	0.75	0.28
3/8	B34C	1/4-18 NPTF	2.38	1.39	0.88	0.36
3/8	B34	3/8-18 NPTF	2.44	1.39	0.88	0.39
3/8	B34F	1/2-14 NPTF	2.57	1.39	0.88	0.41
1/2	B36E	3/8-18 NPTF	2.92	1.52	1.00	0.58
1/2	B36	1/2-14 NPTF	3.09	1.52	1.00	0.61
1/2	B36G	3/4-14 NPTF	3.12	1.52	1.13	0.67
3/4	B38	3/4-14 NPTF	2.95	1.90	1.31	0.91
3/4	B38J	1-11 1/2 NPTF	3.12	1.90	1.31	0.99



WARNING: This product can expose you to chemicals including Lead, which is known to the State of California to cause cancer and birth defects or other reproductive harm. For more information go to www.P65Warnings.ca.gov



Couplers - Standard Hose Barb



Body Size	Part No. Brass	Hose I.D.	Length	Largest Diameter	Wrench Flats	Weight (lbs)
1/4	B30-3B	1/4	2.62	1.20	0.75	0.27
1/4	B30-4B	5/16	2.62	1.20	0.75	0.27
1/4	B30-5B	3/8	2.62	1.20	0.75	0.28
3/8	B34-5B	3/8	2.65	1.39	0.88	0.39
3/8	B34-6B	1/2	2.65	1.39	0.88	0.41
1/2	B36-6B	1/2	3.13	1.52	1.00	0.59
1/2	B36-7B	3/4	3.60	1.52	1.00	0.65
3/4	B38-7B	3/4	3.69	1.90	1.31	0.93
3/4	B38-8B	1	3.93	1.90	1.31	1.03

Couplers - Push Lok Hose Barb*



Body Size	Part No. Brass	Hose I.D.	Length	Largest Diameter	Wrench Flats	Weight (lbs)
1/4	B30-3BP	1/4	2.45	1.20	0.75	0.27
1/4	B30-5BP	3/8	2.60	1.20	0.75	0.29
3/8	B34-5BP	3/8	2.82	1.39	0.88	0.40
1/2	B36-6BP	1/2	3.46	1.52	1.00	0.56

* Push-Lok hose barbs are designed for use with Parker Push-Lok hose and do not require clamps.

Optional Materials and Features:

(add code to part number)

Code	Description	Part Number Example
suffix N	Stainless steel springs, locking balls & brass valves (Couplers)	B34N
suffix -SL	Sleeve-Lok (Couplers)	B34-SL
suffix W	Ethylene Propylene seal material (-65° to + 400° F) (Couplers)	B34W
suffix Y	Fluorocarbon seal material (-30° to + 400° F) (Couplers)	B34Y

Contact QCD for availability and additional options.

To select proper seal materials, see Fluid Compatibility Chart or contact QCD.



WARNING: This product can expose you to chemicals including Lead, which is known to the State of California to cause cancer and birth defects or other reproductive harm. For more information go to www.P65Warnings.ca.gov

Pneumatic Quick Couplings

General Purpose

Rectus 21, 23, 30 Series Couplers

Accepts Industrial Interchange Nipples

Formerly HF Series



Push-to-connect sleeve, single shut off



Performance

Rectus 21, 23, 30 Series (1/8" & 1/4" sizes)

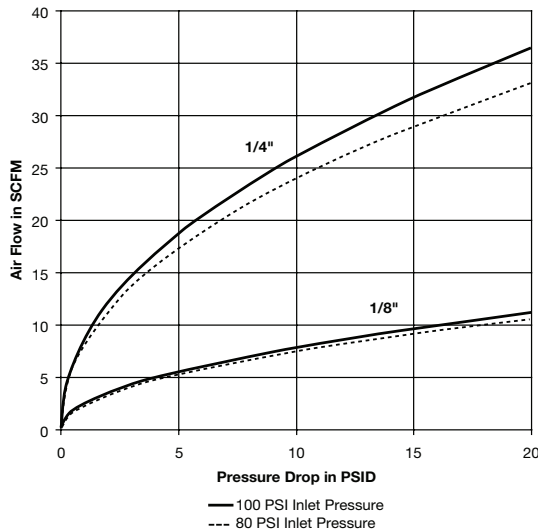

Rectus 21, 23, 30 Series (3/8" sizes)

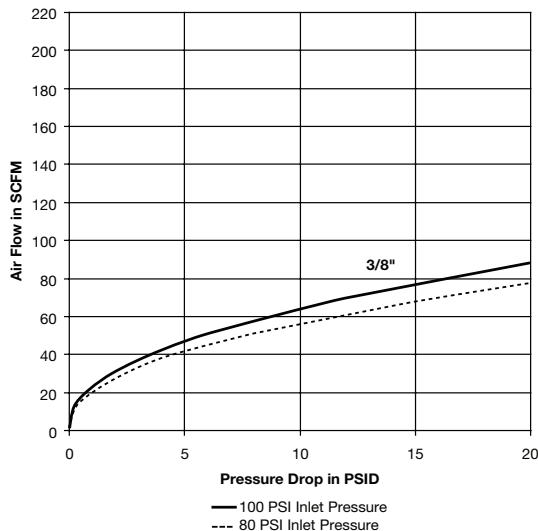

Rectus 21, 23, 30 Series Pneumatic Quick Couplers connect with Industrial Interchange nipples, the standard male tip of the pneumatic industry. The 1/8" and 1/4" couplers have nickel plated brass construction, a corrosion resistant valve, stainless steel locking balls and a stainless steel valve spring. The 3/8" couplers have nickel plated steel construction, a corrosion resistant valve, stainless steel locking pins and a stainless steel valve spring.

Features:

- Integral sleeve guard protects against accidental disconnection
- Push-to-connect operation
- Slim profile

Applications include:

- Air compressors
- Pneumatic tools
- Drop-down air lines

Rectus 21, 23, 30 Series Specifications

Body Size	1/8	1/4	3/8
Rated Pressure (psi)	250	300	300
Temperature Range (std seals)	-4° to +212° F		
Locking Device	5 balls	4 balls	6 balls
Vacuum Data (in. Hg.)			
Disconnected (coupler only)	Not Recommended		



1/8" Body Size Couplers - Female Pipe Thread



Body Size	New Part No. Nickel Plated Brass	Old Part No. Brass	Thread Size	Length	Largest Diameter	Wrench Flats	Weight (lbs.)
1/8	21KAIN10MPN	HF-121-2FP	1/8-27 NPTF	1.42	0.63	0.55	0.06
1/8	21KAIN13MPN	HF-121-4FP	1/4-18 NPTF	1.81	0.63	0.67	0.10

1/8" Body Size Couplers - Male Pipe Thread



Body Size	New Part No. Nickel Plated Brass	Old Part No. Brass	Thread Size	Length	Largest Diameter	Wrench Flats	Weight (lbs.)
1/8	21KAAN10MPN	HF-121-2MP	1/8-27 NPTF	1.50	0.63	0.55	0.06
1/8	21KAAN13MPN	HF-121-4MP	1/4-18 NPTF	1.61	0.63	0.55	0.07

1/8" Body Size Nipples - Female Pipe Thread



Body Size	New Part No. Nickel Plated Brass	Old Part No. Brass	Thread Size	Length	Largest Diameter	Wrench Flats	Weight (lbs.)
1/8	21SFIN10MXN	HF-124-2FP	1/8-27 NPTF	1.08	0.58	0.50	0.03
1/8	21SFIN13MXN	HF-124-4FP	1/4-18 NPTF	1.34	0.78	0.67	0.07

1/8" Body Size Nipples - Male Pipe Thread



Body Size	New Part No. Nickel Plated Brass	Old Part No. Brass	Thread Size	Length	Largest Diameter	Wrench Flats	Weight (lbs.)
1/8	21SFAN10MXN	HF-124-2MP	1/8-27 NPTF	1.06	0.51	0.44	0.03
1/8	21SFAN13MXN	HF-124-4MP	1/4-18 NPTF	1.25	0.63	0.56	0.05



WARNING: This product can expose you to chemicals including Lead, which is known to the State of California to cause cancer and birth defects or other reproductive harm. For more information go to www.P65Warnings.ca.gov



1/4, 3/8" Body Size Couplers - Female Pipe Thread



Body Size	New Part No. Nickel Plated Brass	New Part No. Nickel Plated Steel	Old Part No. Brass	Thread Size	Length	Largest Diameter	Wrench Flats	Weight (lbs.)
1/4	23KAIN13MPN	-	HF-251-4FP	1/4-18 NPSF	2.19	0.99	0.81	0.26
1/4	23KAIN17MPN	-	HF-251-6FP	3/8-18 NPSF	2.34	0.99	0.81	0.27
3/8	-	30KAIN13SPN	HF-371-4FP	1/4-18 NPSF	2.33	1.07	0.94	0.33
3/8	-	30KAIN17SPN	HF-371-6FP	3/8-18 NPSF	2.33	1.07	0.94	0.31
3/8	-	30KAIN21SPN	HF-371-8FP	1/2-14 NPTF	2.49	1.07	1.00	0.35

1/4, 3/8" Body Size Couplers - Male Pipe Thread



Body Size	New Part No. Nickel Plated Brass	New Part No. Nickel Plated Steel	Old Part No. Brass	Thread Size	Length	Largest Diameter	Wrench Flats	Weight (lbs.)
1/4	23KAAN13MPN	-	HF-251-4MP	1/4-18 NPTF	2.34	0.99	0.81	0.25
1/4	23KAAN17MPN	-	HF-251-6MP	3/8-18 NPTF	2.37	0.99	0.81	0.26
3/8	-	30KAAN13SPN	HF-371-4MP	1/4-18 NPTF	2.49	1.07	0.94	0.32
3/8	-	30KAAN17SPN	HF-371-6MP	3/8-18 NPTF	2.52	1.07	0.94	0.3
3/8	-	30KAAN21SPN	HF-371-8MP	1/2-14 NPTF	2.68	1.07	0.94	0.33

1/4, 3/8" Body Size Couplers - Standard Hose Barb



Body Size	New Part No. Nickel Plated Brass	New Part No. Nickel Plated Steel	Old Part No. Brass	Hose I.D.	Length	Largest Diameter	Wrench Flats	Weight (lbs.)
1/4	23KATF06MPN	-	HF-251-4HB	1/4	2.81	0.99	0.81	0.26
1/4	23KATF10MPN	-	HF-251-6HB	3/8	2.81	0.99	0.81	0.27
3/8	-	30KATF10SPN	HF-371-6HB	3/8	3.02	1.07	0.94	0.31
3/8	-	30KATF13SPN	HF-371-8HB	1/2	3.02	1.07	0.94	0.34

1/4, 3/8" Body Size Couplers - Push-Lok Hose Barb*



Body Size	New Part No. Nickel Plated Brass	New Part No. Nickel Plated Steel	Old Part No. Brass	Hose I.D.	Length	Largest Diameter	Wrench Flats	Weight (lbs.)
1/4	23KATP06MPN	-	HF-251-4PL	1/4	2.64	0.99	0.81	0.26
1/4	23KATP10MPN	-	HF-251-6PL	3/8	2.78	0.99	0.81	0.27
3/8	-	30KATP10SPN	HF-371-6PL	3/8	3.02	1.07	0.94	0.33
3/8	-	30KATP13SPN	HF-371-8PL	1/2	3.07	1.07	0.94	0.31

* Push-Lok hose barbs are designed for use with Parker Push-Lok hose and do not require clamps.



WARNING: This product can expose you to chemicals including Lead, which is known to the State of California to cause cancer and birth defects or other reproductive harm. For more information go to www.P65Warnings.ca.gov



Parker's 10 Series Pneumatic Couplers are the original Tru-Flate design, commonly referred to as the automotive interchange. 1/4" body size has a brass body, while standard 3/8" and 1/2" body sizes have all steel construction. Sleeve options include Sleeve-Lok and Grip-Ring sleeve.

Features:

- Integral sleeve guard resists accidental disconnection
- Tubular valve delivers high air flow with minimal pressure drop
- 3/8" and 1/2" size options include brass body with steel sleeve
- Brass body option with stainless steel springs and locking balls is available for added corrosion resistance
- Standard seal is Nitrile
- Steel nipples are case hardened

Applications include:

- Air compressors
- Pneumatic tools
- Water
- Grease
- Paint

Performance 10 Series (1/4", 3/8", 1/2" sizes)

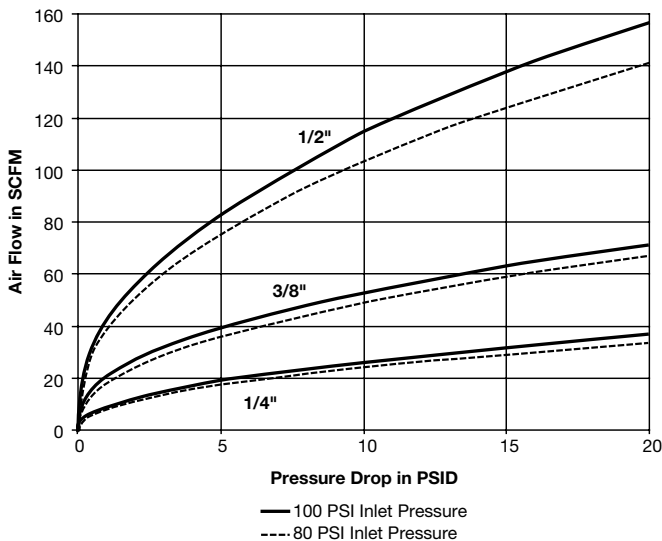

10 Series Specifications

Body Size	1/4	3/8	1/2
Rated Pressure (psi)	300		
Temperature Range (std seals)	-40° to +250° F		
Locking Device	4 balls	8 balls	8 balls
Vacuum Data (in. Hg.)	—		
Disconnected (coupler only)	Not Recommended		
Connected	27.4		

Repair Kits

Body Size	Seal Material	Part No.
1/4	Nitrile	21K
1/4	Ethylene Propylene	21KW
1/4	Fluorocarbon	21KY
3/8	Nitrile	14K
3/8	Ethylene Propylene	14KW
3/8	Fluorocarbon	14KY
1/2	Nitrile	16K
1/2	Ethylene Propylene	16KW
1/2	Fluorocarbon	16KY

Optional Materials and Features:

(add code to part number)

Code	Description	Part Number Example
prefix B	Brass body (Couplers - 3/8" & 1/2" sizes only)	B14F
suffix N	Stainless steel springs, locking balls & brass valves (Couplers)	B15N
suffix -SL	Sleeve-Lok (Couplers)	15-SL
suffix R	Grip Ring sleeve (Couplers)	15R
suffix W	Ethylene Propylene seal material (-65° to +400° F) (Couplers)	B15W
suffix Y	Fluorocarbon seal material (-30° to +400° F) (Couplers)	B15Y

Contact QCD for availability and additional options.

To select proper seal materials, see Fluid Compatibility Chart or contact QCD.



Nipples - Female Pipe Thread



Body Size	Part No. Brass	Part No. Steel	Thread Size	Length	Exposed Length**	Largest Diameter	Wrench Flats	Weight (lbs)
1/4	-	1C	1/8-27 NPTF	1.28	0.55	0.58	0.50	0.05
1/4	B3C	3C	1/4-18 NPTF	1.47	0.74	0.72	0.62	0.05
1/4	-	3C-E	3/8-18 NPTF	1.50	0.77	0.94	0.81	0.07
3/8	-	1E	1/4-18 NPTF	1.60	0.67	0.72	0.62	0.07
3/8	-	3E	3/8-18 NPTF	1.68	0.77	0.94	0.81	0.10
1/2	-	1F	3/8-18 NPTF	2.05	0.83	0.94	0.81	0.13
1/2	-	3F	1/2-14 NPTF	2.27	1.05	1.16	1.00	0.18
1/2	-	H3F-G	3/4-14 NPTF	2.38	1.13	1.44	1.25	0.26

Nipples - Male Pipe Thread



Body Size	Part No. Brass	Part No. Steel	Part No. Stainless ***	Thread Size	Length	Exposed Length**	Largest Diameter	Wrench Flats	Weight (lbs)
1/4	-	0C	-	1/8-27 NPTF	1.47	0.74	0.58	0.50	0.04
1/4	B2C	2C	S2C	1/4-18 NPTF	1.62	0.89	0.65	0.56	0.06
1/4	-	2C-E	-	3/8-18 NPTF	1.72	0.99	0.80	0.69	0.05
3/8	-	0E	-	1/4-18 NPTF	1.88	0.95	0.72	0.62	0.08
3/8	-	2E	-	3/8-18 NPTF	1.90	0.98	0.80	0.69	0.09
1/2	-	0F	-	3/8-18 NPTF	2.33	1.12	0.79	0.69	0.13
1/2	-	2F	-	1/2-14 NPTF	2.48	1.27	1.01	0.88	0.17
1/2	-	H2F-G	-	3/4-14 NPTF	2.53	1.29	1.30	1.13	0.24

** This dimension represents portion of nipple that is exposed when nipple is inserted in a Parker 10 Series coupler

*** Prop 65 Warning does not apply to stainless steel part numbers

Nipples - Standard Hose Barb



Body Size	Part No. Steel	Hose I.D.	Length	Exposed Length**	Largest Diameter	Weight (lbs)
1/4	8C	1/4	1.63	.090	0.45	0.04
1/4	9C	3/8	2.00	1.27	0.55	0.05
3/8	5E	3/8	1.81	0.98	0.59	0.07
1/2	H4F	3/8	2.36	1.29	0.66	0.08
1/2	5F	1/2	2.36	1.60	0.66	0.11
1/2	H5F-G	3/4	2.95	1.91	0.87	0.18

** This dimension represents portion of nipple that is exposed when nipple is inserted in a Parker 10 Series coupler



WARNING: This product can expose you to chemicals including Lead, which is known to the State of California to cause cancer and birth defects or other reproductive harm. For more information go to www.P65Warnings.ca.gov



Nipples - Push-Lok Hose Barb*



Body Size	Part No. Steel	Hose I.D.	Length	Exposed Length**	Largest Diameter	Weight (lbs)
1/4	8CP	1/4	1.66	0.93	0.45	0.04
1/4	9CP	3/8	1.98	1.25	0.86	0.05
3/8	5EP	3/8	1.98	1.06	0.59	0.08
1/2	H4FP	3/8	2.52	1.27	0.86	0.11
1/2	H5FP	1/2	2.66	1.42	0.97	0.11

* Push-Lok hose barbs are designed for use with Parker Push-Lok hose and do not require clamps.

**This dimension represents portion of nipple that is exposed when nipple is inserted in a Parker 10 Series coupler

Couplers - Female Pipe Thread



Body Size	Part No. Brass	Part No. Steel	Thread Size	Length	Largest Diameter	Wrench Flats	Weight (lbs)
1/4	B13A	-	1/8-27 NPTF	1.83	0.90	0.75	0.19
1/4	B13	-	1/4-18 NPTF	1.83	0.90	0.75	0.19
1/4	B13E	-	3/8-18 NPTF	1.95	0.94	0.81	0.31
3/8	-	15C	1/4-18 NPTF	2.22	1.06	0.88	0.30
3/8	B15*	15	3/8-18 NPTF	2.28	1.06	0.88	0.34
3/8	-	15F	1/2-14 NPTF	2.55	1.16	1.00	0.46
1/2	-	17E	3/8-18 NPTF	2.74	1.19	1.00	0.46
1/2	B17*	17	1/2-14 NPTF	2.96	1.19	1.00	0.50
1/2	-	17G	3/4-14 NPTF	3.19	1.44	1.25	0.20

* Coupler has brass body and steel sleeve.

Couplers - Male Pipe Thread



Body Size	Part No. Brass	Part No. Steel	Thread Size	Length	Largest Diameter	Wrench Flats	Weight (lbs)
1/4	B12A	-	1/8-27 NPTF	1.89	0.90	0.75	0.17
1/4	B12	-	1/4-18 NPTF	2.05	0.90	0.75	0.18
1/4	B12E	-	3/8-18 NPTF	2.08	0.90	0.75	0.19
3/8	-	14C	1/4-18 NPTF	2.36	1.06	0.88	0.26
3/8	B14*	14	3/8-18 NPTF	2.39	1.06	0.88	0.27
3/8	-	14F	1/2-14 NPTF	2.55	1.06	0.88	0.28
1/2	-	16E	3/8-18 NPTF	2.93	1.19	1.00	0.42
1/2	B16*	16	1/2-14 NPTF	3.08	1.19	1.00	0.45
1/2	-	16G	3/4-14 NPTF	3.21	1.30	1.13	0.50

* Coupler has brass body and steel sleeve.



WARNING: This product can expose you to chemicals including Lead, which is known to the State of California to cause cancer and birth defects or other reproductive harm. For more information go to www.P65Warnings.ca.gov



Couplers - Standard Hose Barb



Body Size	Part No. Brass	Part No. Steel	Hose I.D.	Length	Largest Diameter	Wrench Flats	Weight (lbs)
1/4	B10-3B	-	1/4	2.49	0.90	0.75	0.18
1/4	B10-4B	-	5/16	2.49	0.90	0.75	-
1/4	B10-5B	-	3/8	2.49	0.90	0.75	0.18
3/8	-	14-5B	3/8	2.60	1.06	0.88	0.26
3/8	-	14-6B	1/2	2.60	1.06	0.88	0.27
1/2	-	16-5B	3/8	3.14	1.19	1.00	0.41
1/2	-	16-6B	1/2	3.14	1.19	1.00	0.43
1/2	-	16-7B	3/4	3.60	1.19	1.00	0.48

Add suffix "N" to brass coupler part number for stainless steel springs and locking balls (ie B15N).

Add suffix "-SL" for Sleeve-Lok option.

Add suffix "R" for grip-ring sleeve (1/4" size only).

Couplers - Push-Lok Hose Barb*



Body Size	Part No. Brass	Part No. Steel	Hose I.D.	Length	Largest Diameter	Wrench Flats	Weight (lbs)
1/4	B10-3BP	-	1/4	2.32	0.90	0.75	0.19
1/4	B10-5BP	-	3/8	2.47	0.90	0.75	0.19
3/8	-	14-5BP	3/8	2.88	1.06	0.88	0.26
1/2	-	16-5BP	3/8	3.35	1.19	1.00	0.40
1/2	-	16-6BP	1/2	3.46	1.19	1.00	0.43

* Push-Lok hose barbs are designed for use with Parker Push-Lok hose and do not require clamps.



WARNING: This product can expose you to chemicals including Lead, which is known to the State of California to cause cancer and birth defects or other reproductive harm. For more information go to www.P65Warnings.ca.gov



50 Series Pneumatic Couplers are interchangeable with ARO's 210 series. Couplers have brass bodies. Nipples are constructed of steel. Sleeve-Lok is an optional feature.

Features:

- Integral sleeve guard resists accidental disconnection
- Tubular valve delivers high air flow with minimal pressure drop
- Stainless steel springs and locking balls option is available for added corrosion resistance
- Standard seal is Nitrile

Applications include:

- Air compressors
- Pneumatic tools
- Water
- Grease
- Paint



Performance 50 Series (1/4" size)

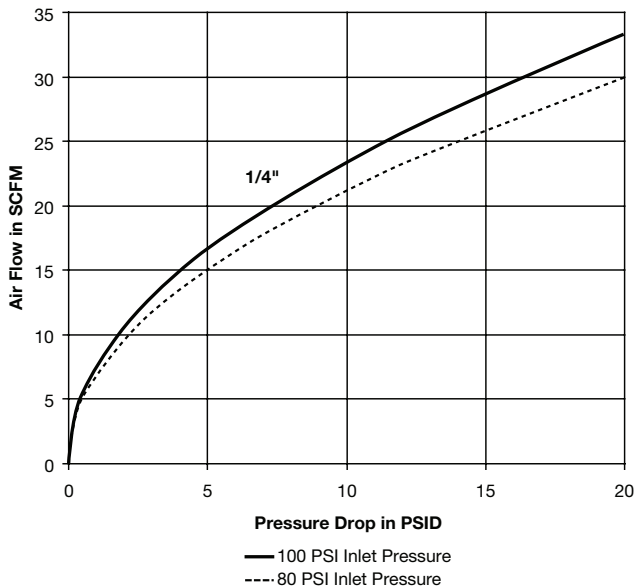

50 Series Specifications	
Body Size	1/4
Rated Pressure (psi)	300
Temperature Range (std seals)	-40° to +250° F
Locking Device	4 balls
Vacuum Service	Not Recommended

Repair Kits		
Body Size	Seal Material	Part No.
1/4	Nitrile	21K
1/4	Ethylene Propylene	21KW
1/4	Fluorocarbon	21KY

Optional Materials and Features:

(add code to part number)

Code	Description	Part Number Example
suffix N	Stainless steel springs, locking balls & brass valves (Couplers)	B52N
suffix -SL	Sleeve-Lok (Couplers)	B52-SL
suffix W	Ethylene Propylene seal material (-65° to + 400° F) (Couplers)	B52W
suffix Y	Fluorocarbon seal material (-30° to + 400° F) (Couplers)	B52Y

Contact QCD for availability and additional options.
To select proper seal materials, see Fluid Compatibility Chart or contact QCD.



Nipples - Female Pipe Thread



Body Size	Part No. Steel	Thread Size	Length	Largest Diameter	Exposed Length**	Wrench Flats	Weight (lbs)
1/4	A3C	1/4-18 NPTF	1.47	0.72	0.66	0.62	0.04

Nipples - Male Pipe Thread



Body Size	Part No. Steel	Thread Size	Length	Largest Diameter	Exposed Length**	Wrench Flats	Weight (lbs)
1/4	A2C	1/4-18 NPTF	1.62	0.65	0.82	0.56	0.05

Nipples - Standard Hose Barb



Body Size	Part No. Steel	Hose I.D.	Length	Largest Diameter	Exposed Length**	Wrench Flats	Weight (lbs)
1/4	A8C	1/4	1.63	.043	0.82	0.62	0.03

Nipples - Push-Lok Hose Barb*



Body Size	Part No. Steel	Hose I.D.	Length	Largest Diameter	Exposed Length**	Wrench Flats	Weight (lbs)
1/4	A8CP	1/4	1.65	.067	0.87	0.62	0.03

* Push-Lok hose barbs are designed for use with Parker Push-Lok hose and do not require clamps.

**This dimension represents portion of nipple that is exposed when nipple is inserted in a Parker 50 Series coupler



WARNING: This product can expose you to chemicals including Lead, which is known to the State of California to cause cancer and birth defects or other reproductive harm. For more information go to www.P65Warnings.ca.gov



Couplers - Female Pipe Thread



Body Size	Part No. Brass	Thread Size	Length	Largest Diameter	Wrench Flats	Weight (lbs)
1/4	B53	1/4-18 NPTF	1.83	0.90	0.75	0.20
1/4	B53E	3/8-18 NPTF	1.95	0.94	0.81	0.21

Couplers - Male Pipe Thread



Body Size	Part No. Brass	Thread Size	Length	Largest Diameter	Wrench Flats	Weight (lbs)
1/4	B52	1/4-18 NPTF	2.05	0.90	0.75	0.20
1/4	B52E	3/8-18 NPTF	2.08	0.90	0.75	0.21

Couplers - Push-Lok Hose Barb*



Body Size	Part No. Brass	Hose I.D.	Length	Largest Diameter	Wrench Flats	Weight (lbs)
1/4	B50-3BP	1/4	2.32	0.90	0.75	0.19
1/4	B50-5BP	3/8	2.47	0.90	0.75	0.20

* Push-Lok hose barbs are designed for use with Parker Push-Lok hose and do not require clamps.



WARNING: This product can expose you to chemicals including Lead, which is known to the State of California to cause cancer and birth defects or other reproductive harm. For more information go to www.P65Warnings.ca.gov

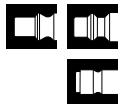

UC Series Pneumatic Quick Couplers connect with Industrial Interchange, 10 series (Tru-Flate), and 50 series (ARO 210) style nipples. While the best performance is obtained by matching like series couplers and nipples, the Universal Coupler permits multiple series nipples to mate with one coupler.

Features:

- Sleeve guard protects against accidental disconnection
- Push-to-connect operation
- Brass construction
- One coupler connects with three nipple styles
- UC Series is a replacement for the HA Series.

Applications include:

- Air compressors
- Pneumatic tools
- Drop-down air lines

Performance

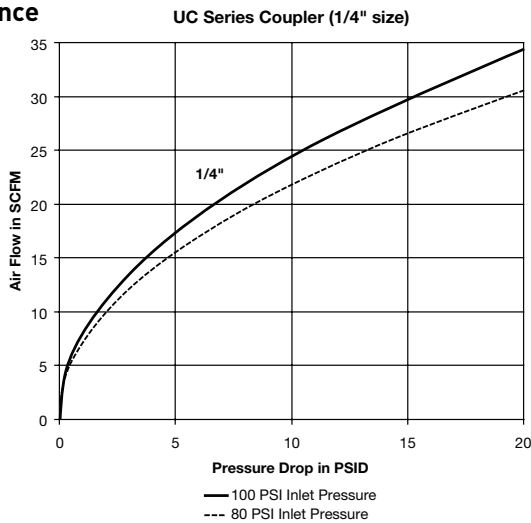

UC Series Specifications

Body Size	Rated Pressure (psi)	Temperature Range (Nitrile seals)	Locking Device	Vacuum Service
1/4	150	-40° to +250° F	4 balls	Not Recommended

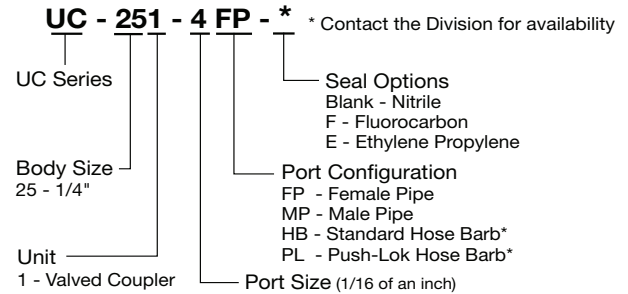

Couplers - Female Pipe Thread



Body Size	Part No. Brass	Thread Size	Length	Largest Diameter	Wrench Flats	Weight (lbs.)
1/4	UC-251-4FP	1/4-18 NPSF	2.06	0.98	0.81	0.23
1/4	UC-251-6FP	3/8-18 NPSF	2.21	0.98	0.81	0.23

Couplers - Male Pipe Thread



Body Size	Part No. Brass	Thread Size	Length	Largest Diameter	Wrench Flats	Weight (lbs.)
1/4	UC-251-4MP	1/4-18 NPTF	2.21	0.98	0.81	0.22
1/4	UC-251-6MP	3/8-18 NPTF	2.24	0.98	0.81	0.23



WARNING: This product can expose you to chemicals including Lead, which is known to the State of California to cause cancer and birth defects or other reproductive harm. For more information go to www.P65Warnings.ca.gov



70 Series Pneumatic Couplers are interchangeable with Lincoln's "Long Stem" series couplings. Couplers have brass bodies and steel valves. Nipples are constructed of steel. Sleeve-Lok is an optional feature.

Features

- Integral sleeve guard resists accidental disconnection
- Tubular valve delivers high air flow with minimal pressure drop
- Standard seal is Nitrile

Applications:

- Air compressors
- Pneumatic tools
- Water
- Grease
- Paint

Performance 70 Series (1/4" size)

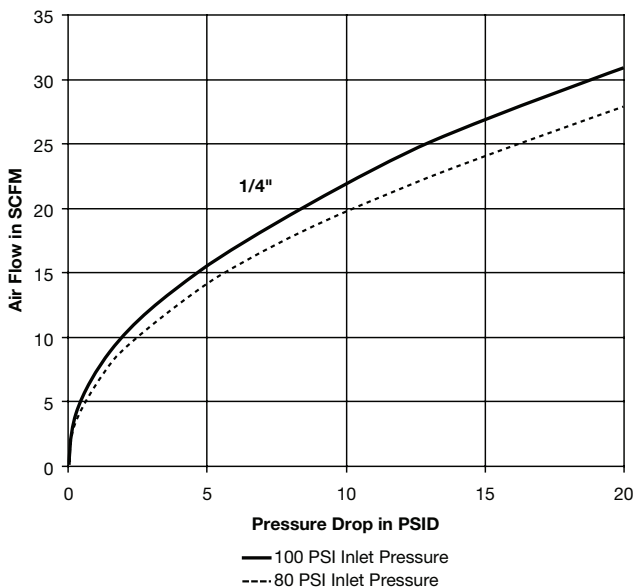

70 Series Specifications	
Body Size	1/4
Rated Pressure (psi)	300
Temperature Range (std seals)	-40° to +250° F
Locking Device	4 balls
Vacuum Service	Not Recommended

Repair Kits		
Body Size	Seal Material	Part No.
1/4	Nitrile	21K
1/4	Ethylene Propylene	21KW
1/4	Fluorocarbon	21KY

Couplers - Female Pipe Thread



Body Size	Part No. Brass	Thread Size	Length	Largest Diameter	Wrench Flats	Weight (lbs.)
1/4	B73	1/4-18 NPTF	2.40	0.90	0.75	0.25

WARNING: This product can expose you to chemicals including Lead, which is known to the State of California to cause cancer and birth defects or other reproductive harm. For more information go to www.P65Warnings.ca.gov

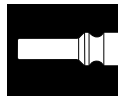

Couplers - Male Pipe Thread



Body Size	Part No. Brass	Thread Size	Length	Largest Diameter	Wrench Flats	Weight (lbs.)
1/4	B72	1/4-18 NPTF	2.62	0.90	0.75	0.25

Nipples - Female Pipe Thread



Body Size	Part No. Steel	Thread Size	Length	Exposed Length*	Largest Diameter	Wrench Flats	Weight (lbs.)
1/4	L3C	1/4-18 NPTF	2.10	0.77	0.65	0.56	0.05

Nipples - Male Pipe Thread



Body Size	Part No. Steel	Thread Size	Length	Exposed Length*	Largest Diameter	Wrench Flats	Weight (lbs.)
1/4	L2C	1/4-18 NPTF	2.25	0.92	0.65	0.56	0.06

* This dimension represents portion of nipple that is exposed when nipple is inserted in a Parker 70 Series coupler.

Optional Materials and Features:

(add code to part number)

Code	Description	Part Number Example
suffix N	Stainless steel springs, locking balls & brass valves (Couplers)	B72N
suffix -SL	Sleeve-Lok (Couplers)	B72-SL
suffix W	Ethylene Propylene seal material (-65° to + 400° F) (Couplers)	B72W
suffix Y	Fluorocarbon seal material (-30° to + 400° F) (Couplers)	B72Y

Contact QCD for availability and additional options.

To select proper seal materials, see Fluid Compatibility Chart or contact QCD.



WARNING: This product can expose you to chemicals including Lead, which is known to the State of California to cause cancer and birth defects or other reproductive harm. For more information go to www.P65Warnings.ca.gov



Rectus 25 Series Pneumatic Couplers are designed to increase flow and reduce pressure drop through the coupling. Rectus 25 nipples have up to 2-1/2 times larger flow area than standard industrial interchange nipples. The increased flow results in greater tool efficiency and decreased air costs. Couplers are nickel plated brass and nipples are steel.



Features:

- Aerodynamic valve design
- Flow rates on 1/4" is greater than many 3/8" body size couplers
- Integral sleeve guard protects against accidental disconnection
- Functionally interchanges with a common high-flow European design. 1/4 Rectus 25 interchanges with CEJN 320.
- Standard seal is Nitrile

Applications include:

- Air compressors
- Pneumatic tools
- Drop-down air lines

Performance Rectus 25 Series (1/4" body size)
with 1/4" Female NPSF

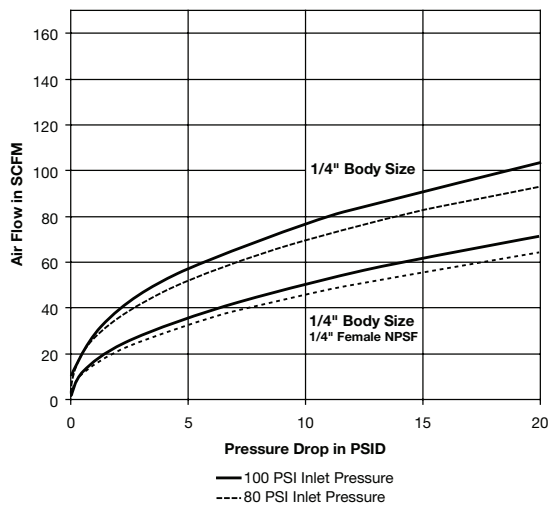

Rectus 25 Series Specifications	
Body Size	1/4
Rated Pressure (psi)	300
Temperature Range (std seals)	-4° to +212° F
Locking Device	4 balls
Vacuum Service	Not Recommended



Couplers - Female Pipe Thread



Body Size	New Part No. Nickel Plated Brass	Old Part No. Brass	Thread Size	Length	Largest Diameter	Wrench Flats	Weight (lbs.)
1/4	25KAIN13MPN	RF-251-4FP	1/4-18 NPSF	2.19	0.99	0.81	0.26
1/4	25KAIN17MPN	RF-251-6FP	3/8-18 NPSF	2.34	0.99	0.81	0.27

Couplers - Male Pipe Thread



Body Size	New Part No. Nickel Plated Brass	Old Part No. Brass	Thread Size	Length	Largest Diameter	Wrench Flats	Weight (lbs.)
1/4	25KAAN13MPN	RF-251-4MP	1/4-18 NPTF	2.34	0.99	0.81	0.24
1/4	25KAAN17MPN	RF-251-6MP	3/8-18 NPTF	2.37	0.99	0.81	0.25

Couplers - Standard Hose Barb



Body Size	New Part No. Nickel Plated Brass	Old Part No. Brass	Hose I.D.	Length	Largest Diameter	Wrench Flats	Weight (lbs.)
1/4	25KATF06MPN	RF-251-4HB	1/4	2.81	0.99	0.81	0.26
1/4	25KATF10MPN	RF-251-6HB	3/8	2.81	0.99	0.81	0.27

Couplers - Push-Lok Hose Barb*



Body Size	New Part No. Nickel Plated Brass	Old Part No. Brass	Hose I.D.	Length	Largest Diameter	Wrench Flats	Weight (lbs.)
1/4	25KATP06MPN	RF-251-4PL	1/4	2.64	0.99	0.81	0.26
1/4	25KATP10MPN	RF-251-6PL	3/8	2.78	0.99	0.81	0.27

* Push-Lok hose barbs are designed for use with Parker Push-Lok hose and do not require clamps.



WARNING: This product can expose you to chemicals including Lead, which is known to the State of California to cause cancer and birth defects or other reproductive harm. For more information go to www.P65Warnings.ca.gov



A Pneumatics

Nipples - Female Pipe Thread



Body Size	New Part No. Steel	Old Part No. Steel	Thread Size	Length	Largest Diameter	Wrench Flats	Weight (lbs.)
1/4	25SFIN13SXZ	RF-254-4FP	1/4-18 NPTF	1.45	0.72	0.62	0.06
1/4	25SFIN17SXZ	RF-254-6FP	3/8-18 NPTF	1.50	0.94	0.81	0.09

Nipples - Male Pipe Thread



Body Size	New Part No. Steel	Old Part No. Steel	Thread Size	Length	Largest Diameter	Wrench Flats	Weight (lbs.)
1/4	25SFAN13SXZ	RF-254-4MP	1/4-18 NPTF	1.60	0.65	0.56	0.05
1/4	25SFAN17SXZ	RF-254-6MP	3/8-18 NPTF	1.67	0.75	0.69	0.08

Nipples - Standard Hose Barb



Body Size	New Part No. Steel	Old Part No. Steel	Hose I.D.	Length	Largest Diameter	Weight (lbs.)
1/4	25SFTF06SXZ	RF-254-4HB	1/4	1.66	0.50	0.04
1/4	25SFTF10SXZ	RF-254-6HB	3/8	1.66	0.50	0.05

Nipples - Push-Lok Hose Barb*



Body Size	New Part No. Steel	Old Part No. Steel	Hose I.D.	Length	Largest Diameter	Weight (lbs.)
1/4	25SFTP06SXN	RF-254-4PL	1/4	1.69	0.50	0.04
1/4	25SFTP10SXN	RF-254-6PL	3/8	1.83	0.50	0.05

* Push-Lok hose barbs are designed for use with Parker Push-Lok hose and do not require clamps.



WARNING: This product can expose you to chemicals including Lead, which is known to the State of California to cause cancer and birth defects or other reproductive harm. For more information go to www.P65Warnings.ca.gov

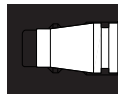

TL Series Pneumatic Couplers are interchangeable with Schraders Twist-Lock style couplings. Couplers have brass bodies and steel sleeves. Nipples are constructed of steel.

Features:

- Designed to resist accidental disconnection
- Push-to-connect, twist sleeve 1/8 turn to disconnect
- Tubular valve delivers high air flow with minimal pressure drop
- Standard seal is Nitrile

Applications include:

- Air compressors
- Pneumatic tools
- Water
- Grease
- Paint

Performance

Twist-Lock Series (1/4" size)

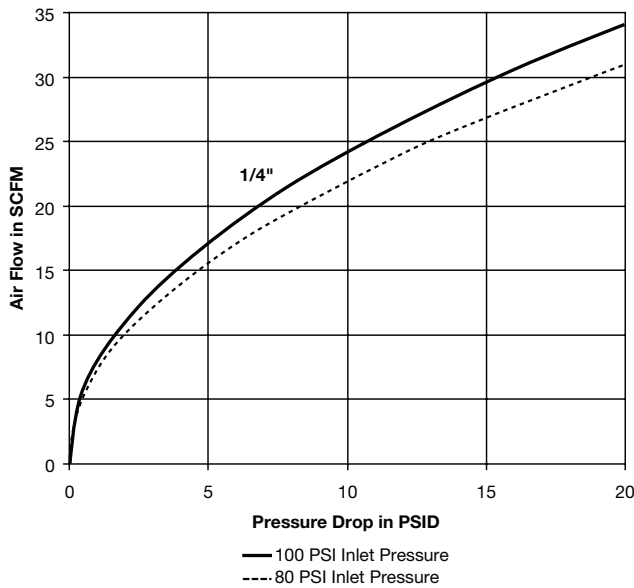

TL Series Specifications

Body Size	1/4	1/2
Rated Pressure (psi)	300	
Temperature Range (std seals)	-40° to +250° F	
Locking Device	CAM	
Vacuum Service	Not recommended	

How To Order

TL - 25 1 - 4 FP

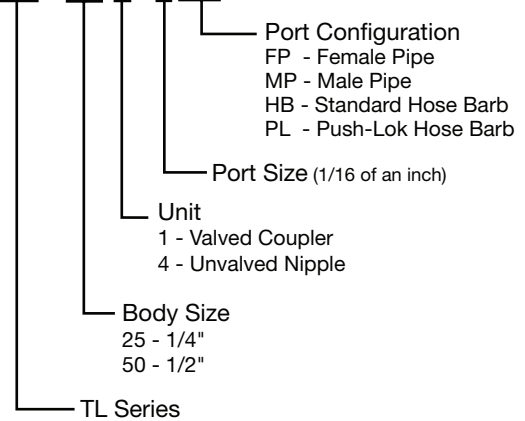

Repair Kits

Body Size	Seal Material	Part No.
1/4	Nitrile	21K
1/4	Ethylene Propylene	21KW
1/4	Fluorocarbon	21KY
1/2	Nitrile	16K
1/2	Ethylene Propylene	16KW
1/2	Fluorocarbon	16KY

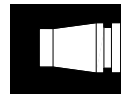

Couplers - Female Thread



Body Size	Part No.	Thread Size	Length	Largest Diameter	Wrench Flats	Weight (lbs)
1/4	TL-251-4FP	1/4-18 NPTF	2.01	1.12	0.75	0.21
1/2	TL-501-6FP	3/8-18 NPTF	2.55	1.50	1.13	0.44
1/2	TL-501-8FP	1/2-14 NPTF	2.78	1.50	1.13	0.44
1/2	TL-501-12FP	3/4-14 NPTF	2.91	1.50	1.13	0.44

Couplers - Male Thread



Body Size	Part No.	Thread Size	Length	Largest Diameter	Wrench Flats	Weight (lbs)
1/4	TL-251-4MP	1/4-18 NPTF	2.23	1.12	0.75	0.21
1/4	TL-251-6MP	3/8-18 NPTF	2.26	1.12	0.75	0.22
1/2	TL-501-6MP	3/8-18 NPTF	2.71	1.50	1.13	0.39
1/2	TL-501-8MP	1/2-14 NPTF	2.88	1.50	1.13	0.40

Optional Seal Materials:
(add code to part number)

Code	Description	Part Number Example
suffix W	Ethylene Propylene seal material (-65° to + 400° F) [Couplers]	TL-251-4FPW
suffix Y	Fluorocarbon seal material (-30° to + 400° F) [Couplers]	TL-251-4FPY

Contact QCD for availability and additional options.
To select proper seal materials, see Fluid Compatibility Chart or contact QCD.



WARNING: This product can expose you to chemicals including Lead, which is known to the State of California to cause cancer and birth defects or other reproductive harm. For more information go to www.P65Warnings.ca.gov

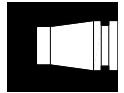

Nipples - Female Thread



Body Size	Part No.	Thread Size	Length	Largest Diameter	Wrench Flats	Weight (lbs)
1/4	TL-254-2FP	1/8-27 NPTF	1.50	0.58	0.50	0.04
1/4	TL-254-4FP	1/4-18 NPTF	1.60	0.72	0.63	0.06
1/2	TL-504-4FP	1/4-18 NPTF	1.90	0.80	0.69	0.12
1/2	TL-504-6FP	3/8-18 NPTF	1.75	0.94	0.81	0.13

Nipples - Male Thread



Body Size	Part No.	Thread Size	Length	Largest Diameter	Wrench Flats	Weight (lbs)
1/4	TL-254-2MP	1/8-27 NPTF	1.68	0.58	0.50	0.05
1/4	TL-254-4MP	1/4-18 NPTF	1.72	0.65	0.56	0.06
1/2	TL-504-4MP	1/4-18 NPTF	1.90	0.80	0.69	0.12
1/2	TL-504-6MP	3/8-18 NPTF	1.90	0.80	0.69	0.12
1/2	TL-504-8MP	1/2-14 NPTF	2.06	1.01	0.88	0.16
1/2	TL-504-12MP	3/4-14 NPTF	2.12	1.22	1.06	0.22

Nipples - Standard Hose Barb



Body Size	Part No.	Hose I.D.	Length	Largest Diameter	Weight (lbs)
1/4	TL-254-4HB	1/4	1.83	0.50	0.03
1/4	TL-254-6HB	3/8	1.83	0.50	0.04
1/2	TL-504-4HB	1/4	2.06	0.67	0.07
1/2	TL-504-6HB	3/8	2.06	0.67	0.08
1/2	TL-504-8HB	1/2	2.06	0.67	0.10



WARNING: This product can expose you to chemicals including Lead, which is known to the State of California to cause cancer and birth defects or other reproductive harm. For more information go to www.P65Warnings.ca.gov

Pneumatic Quick Couplings

General Purpose

IH Series

Snap-tite Design

Manual Sleeve, Single Shut-off



A Pneumatics



IH couplers are steel with a cylindrical valve designed specifically for pneumatic use. When paired with an unvalved/plain H Series nipple, it functions as a durable single shut-off connection. Standard seal is nitrile.

Features:

- Sizes 1/4" - 3/4"
- Steel body material
- Standard seal material is nitrile with other options available
- Optional sleeve lock helps to prevent accidental disconnection
- Manually operated sleeve provides secure connection
- Coupler has 360° cylindrical valve contact

Applications include:

- Industrial air lines
- Pneumatic tools

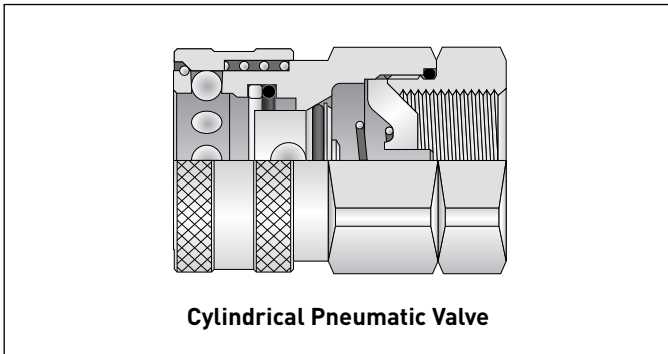

IH Series Working Pressures (psi)				
Valved on coupler and unvalved nipple (Single Shut-off)				
Body Size	1/4	3/8	1/2	3/4
Steel	6500	4500	4000	3500

NOTE: Pressure ratings were established under static pressure conditions. Therefore, pressure ratings for any given flow, pressure surge and/or vibration may vary from these ratings. Burst pressures listed were taken at the point at which failure rendered the quick disconnect inoperative. (Proof pressure equals 1-1/2 times the working pressure; burst pressure equals 2 times working pressure.)

Performance

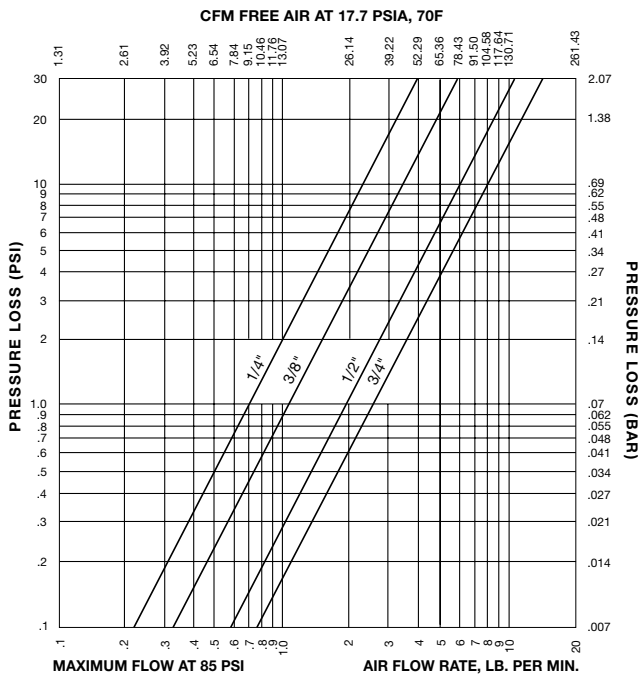



IH Series Couplers - Valved



Body Size	Part No. Steel	Thread Size	Length	Largest Diameter	Wrench Flats	Sleeve Lock
1/4	VIHC4-4F	1/4 -18 NPTF (female)	1.65	1.19	1.00	
1/4	VIHC4-4FSL	1/4 -18 NPTF (female)	1.65	1.19	1.00	Y
1/4	VIHC4-4M	1/4 -18 NPT (male)	2.09	1.02	0.88	
1/4	VIHC4-4MSL	1/4 -18 NPT (male)	2.09	1.02	0.88	Y
3/8	VIHC6-6F	3/8 -18 NPTF (female)	1.90	1.19	1.00	
3/8	VIHC6-6FSL	3/8 -18 NPTF (female)	1.90	1.19	1.00	Y
3/8	VIHC6-6M	3/8 -18 NPT (male)	2.19	1.19	1.00	
3/8	VIHC6-6MSL	3/8 -18 NPT (male)	2.19	1.19	1.00	Y
1/2	VIHC8-8F	1/2 -14 NPTF (female)	2.09	1.39	1.19	
3/4	VIHC12-12F	3/4 -14 NPTF (female)	2.42	1.73	1.50	

H Series Nipples - Unvalved / Plain



Body Size	Part No. Steel	Thread Size	Length	Largest Diameter	Wrench Flats
1/4	PHN4-4F	1/4 -18 NPTF (female)	1.32	0.73	0.88
1/4	PHN4-4M	1/4 -18 NPT (male)	0.78	0.65	0.56
3/8	PHN6-6F	3/8 -18 NPTF (female)	1.52	0.94	0.81
3/8	PHN6-6M	3/8 -18 NPT (male)	0.98	0.80	0.69
1/2	PHN8-8F	1/2 -14 NPTF (female)	1.72	1.15	1.00
1/2	PHN8-8M	1/2 -14 NPTF (male)	1.01	1.02	0.88
3/4	PHN12-12F	3/4 -14 NPT (female)	1.92	1.37	1.19
3/4	PHN12-12M	3/4 -14 NPT (male)	1.14	1.22	1.06



WARNING: This product can expose you to chemicals including Lead, which is known to the State of California to cause cancer and birth defects or other reproductive harm. For more information go to www.P65Warnings.ca.gov



Tool-Mate Series are light weight and easy to operate with a non-marring body. Couplers are constructed of Polyamide material with galvanized steel port ends. Springs, balls and pins are stainless steel and locking fingers are polyacetate. Grey body color designates standard, non-venting style coupler.

Features:

- Push-to-connect operation, pull sleeve in the direction of the arrow to release the nipple
- PBH part number (yellow ring) couplers connect with Industrial Interchange nipples
- PER part number (green ring) couplers connect with Rectus 25 series nipples
- Standard seal is Nitrile

Applications include:

- Pneumatic tools
- Drop-down air lines

Performance

Tool-Mate Series Standard (1/4" & 3/8" sizes)

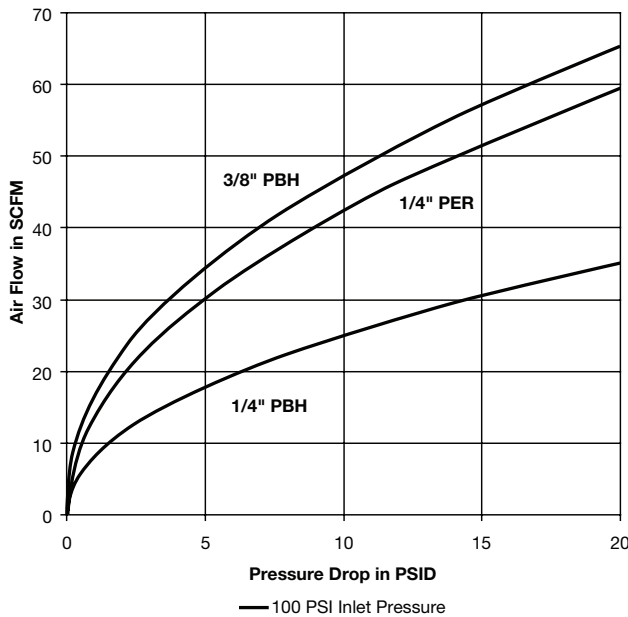

Tool Mate Standard Series Specifications

Body Size	1/4	3/8
Rated Pressure (psi)	300	
Temperature Range	0 to 160° F	
Vacuum Service	Not recommended	

How To Order

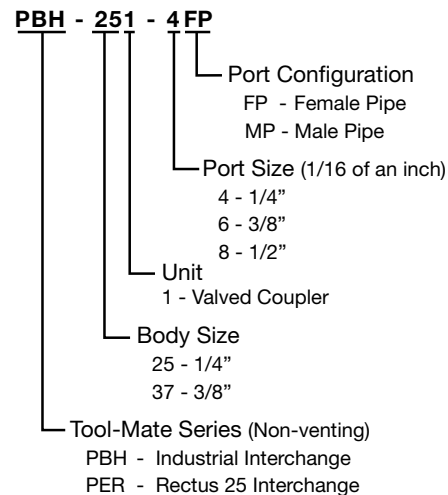



Industrial Interchange - Female Pipe Thread



Body Size	Part No.	Thread Size	Length	Largest Diameter	Wrench Flats	Weight (lbs)
1/4	PBH-251-4FP	1/4-18 NPTF	2.60	1.19	0.67	0.13
1/4	PBH-251-6FP	3/8-18 NPTF	2.67	1.19	0.91	0.15
3/8	PBH-371-4FP	1/4-18 NPTF	2.95	1.38	0.67	0.21
3/8	PBH-371-6FP	3/8-18 NPTF	2.95	1.38	0.83	0.20
3/8	PBH-371-8FP	1/2-14 NPTF	3.17	1.38	0.99	0.22

Industrial Interchange - Male Pipe Thread



Body Size	Part No.	Thread Size	Length	Largest Diameter	Wrench Flats	Weight (lbs)
1/4	PBH-251-4MP	1/4-18 NPTF	2.97	1.19	0.67	0.14
1/4	PBH-251-6MP	3/8-18 NPTF	2.99	1.19	0.91	0.19
3/8	PBH-371-4MP	1/4-18 NPTF	3.39	1.38	0.83	0.23
3/8	PBH-371-6MP	3/8-18 NPTF	3.39	1.38	0.83	0.23

Rectus 25 Interchange - Female Pipe Thread



Body Size	Part No.	Thread Size	Length	Largest Diameter	Wrench Flats	Weight (lbs)
1/4	PER-251-4FP	1/4-18 NPTF	2.83	1.25	0.83	0.17
1/4	PER-251-6FP	3/8-18 NPTF	2.83	1.25	0.83	0.15

Rectus 25 Interchange - Male Pipe Thread



Body Size	Part No.	Thread Size	Length	Largest Diameter	Wrench Flats	Weight (lbs)
1/4	PER-251-4MP	1/4-18 NPTF	2.36	1.25	0.83	0.19
1/4	PER-251-6MP	3/8-18 NPTF	2.40	1.25	0.83	0.18



WARNING: This product can expose you to chemicals including Lead, which is known to the State of California to cause cancer and birth defects or other reproductive harm. For more information go to www.P65Warnings.ca.gov



Tool-Mate Series are light weight and easy to operate with a non-marring body. Exhaust style couplers allow disconnection at zero pressure to avoid dangerous hose whip. Couplers are constructed of Polyamide material with galvanized steel port ends. Springs, balls and pins are stainless steel and locking fingers are polyacetate. Black body color designates venting, exhaust style coupler.

Features:

- Meets ISO 4414 requirements for a controlled pressure release system
- Push-to-connect operation, two step disconnection as indicated by the arrows, provides safe venting of downstream pressure
- PBS part number (yellow ring) couplers connect with Industrial Interchange nipples
- PES part number (green ring) couplers connect with Rectus 25 series nipples
- Standard seal is Nitrile

Applications include:

- Pneumatic tools
- Drop-down air lines

Performance

Tool-Mate Series Exhaust (1/4", 3/8" & 1/2" sizes)

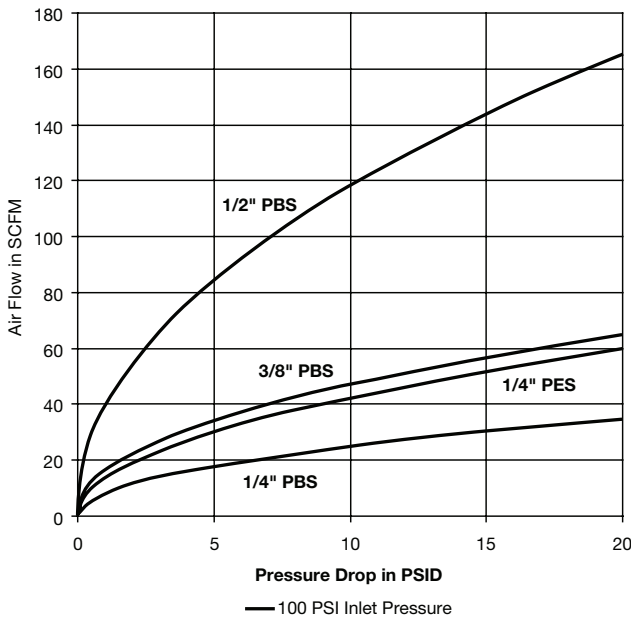

Tool Mate Exhaust Series Specifications

Body Size	1/4	3/8	1/2
Rated Pressure (psi)	300		
Temperature Range	0 to 160° F		
Vacuum Service	Not recommended		

How To Order

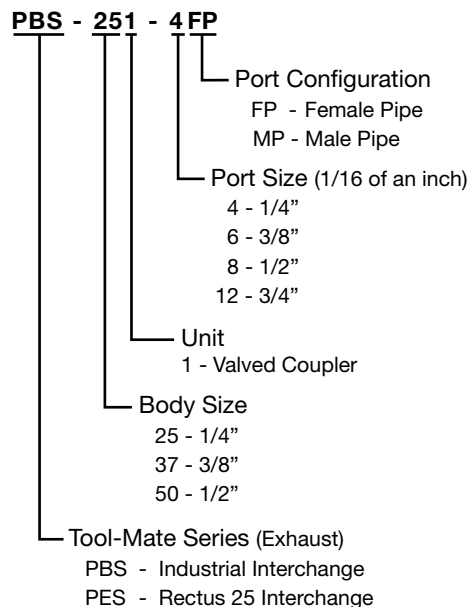



Exhaust Industrial Interchange - Female Pipe Thread



Body Size	Part No.	Thread Size	Length	Largest Diameter	Wrench Flats	Weight (lbs)
1/4	PBS-251-4FP	1/4-18 NPTF	2.60	1.19	0.67	0.13
1/4	PBS-251-6FP	3/8-18 NPTF	2.67	1.19	0.91	0.15
3/8	PBS-371-6FP	3/8-18 NPTF	2.95	1.38	0.82	0.20
3/8	PBS-371-8FP	1/2-14 NPTF	3.17	1.38	0.99	0.22
1/2	PBS-501-6FP	3/8-18 NPTF	3.25	1.62	1.18	0.50
1/2	PBS-501-8FP	1/2-14 NPTF	3.36	1.62	1.18	0.50
1/2	PBS-501-12FP	3/4-14 NPTF	3.66	1.62	1.18	0.50

Exhaust Industrial Interchange - Male Pipe Thread



Body Size	Part No.	Thread Size	Length	Largest Diameter	Wrench Flats	Weight (lbs)
1/4	PBS-251-4MP	1/4-18 NPTF	2.97	1.19	0.67	0.14
1/4	PBS-251-6MP	3/8-18 NPTF	2.99	1.19	0.91	0.19
3/8	PBS-371-6MP	3/8-18 NPTF	3.39	1.38	0.82	0.23
3/8	PBS-371-8MP	1/2-14 NPTF	3.39	1.38	0.91	0.28
1/2	PBS-501-8MP	1/2-14 NPTF	3.70	1.62	1.18	0.50

Exhaust Rectus 25 Interchange - Female Pipe Thread



Body Size	Part No.	Thread Size	Length	Largest Diameter	Wrench Flats	Weight (lbs)
1/4	PES-251-6FP	3/8-18 NPTF	2.83	0.83	0.83	0.15

Exhaust Rectus 25 Interchange - Male Pipe Thread



Body Size	Part No.	Thread Size	Length	Largest Diameter	Wrench Flats	Weight (lbs)
1/4	PES-251-4MP	1/4-18 NPTF	2.36	1.25	0.83	0.19



WARNING: This product can expose you to chemicals including Lead, which is known to the State of California to cause cancer and birth defects or other reproductive harm. For more information go to www.P65Warnings.ca.gov



E-z-mate Series are exhaust type quick couplers that are designed to safely relieve air pressure prior to disconnection. When the valve sleeve is twisted to shut off air flow, it automatically vents downstream allowing for disconnection at zero pressure and eliminating the risk of "hose whip".

Features:

- Self-locking valve sleeve protects against accidental disconnection
- Push-to-connect operation
- Meets ISO 4414 requirements for a controlled pressure release system
- Connection and disconnection at zero pressure
- Brass material option - contact QCD for availability

Applications include:

- Pneumatic tools
- Drop-down air lines

Operation

Parker E-z-mate couplings combine push-to-connect, exhaust-style action with a self-locking valve sleeve to guard against accidental disconnection. Simply follow the direction of the On-Off arrow stamped on the valve sleeve. It's that easy.

To connect, push the nipple into the coupler. The black locking sleeve automatically slides forward securely locking the nipple in place. No air is allowed to flow through the coupling at this point. The valve sleeve is then rotated clockwise (when viewed from the coupler port end) to open flow and automatically engage the sleeve-lock mechanism.

To disconnect, rotate the valve sleeve counter clockwise (when viewed from the coupler end). The flow of air through the coupling will be shut off and all downstream air is vented to the atmosphere. The locking sleeve may now be retracted and the nipple removed. Lubricate sleeve as part of periodic maintenance to coupler.

Performance

E-z-mate Series (1/4" & 3/8" sizes)

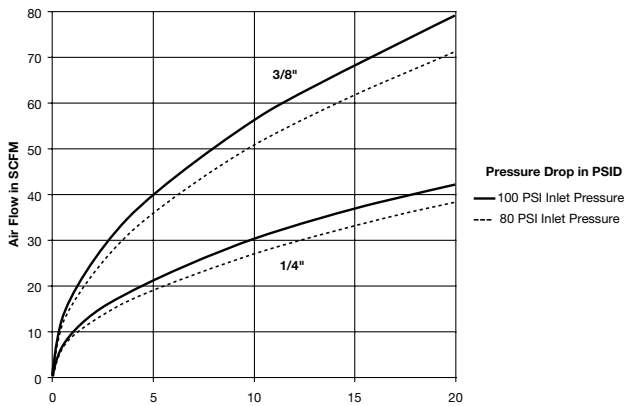

E-z-mate Series (1/2" & 3/4" sizes)

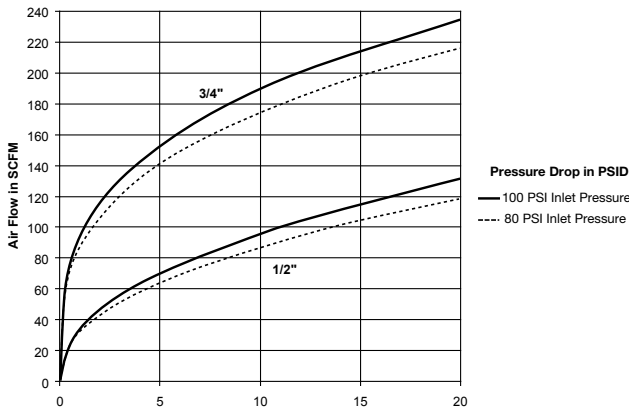

EZ - 251 - 4 FP

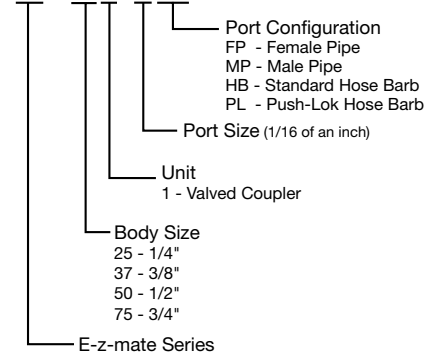

E-z-mate Series Specifications

Body Size	1/4	3/8	1/2	3/4
Rated Pressure (psi)	300			
Temperature Range (std seals)	-40° to +250° F			
Locking Device	4 balls	4 balls	6 balls	8 balls
Force required to connect (lbs.)	Less than 10			
Vacuum Service	Not Recommended			



Couplers - Female Pipe Thread



Body Size	Part No.	Thread Size	Length	Largest Diameter	Wrench Flats	Weight (lbs)
1/4	EZ-251-4FP	1/4-18 NPTF	2.25	1.00	0.75	0.25
1/4	EZ-251-6FP	3/8-18 NPTF	2.68	1.01	0.88	0.29
3/8	EZ-371-6FP	3/8-18 NPTF	2.53	1.18	0.88	0.38
3/8	EZ-371-8FP	1/2-14 NPTF	3.00	1.30	1.12	0.50
1/2	EZ-501-8FP	1/2-14 NPTF	3.01	1.38	1.12	0.65
1/2	EZ-501-12FP	3/4-14 NPTF	3.44	1.59	1.38	0.70
3/4	EZ-751-12FP	3/4-14 NPTF	3.01	1.57	1.38	0.76
3/4	EZ-751-16FP	1-11 1/2 NPTF	3.52	1.80	1.56	0.92

Couplers - Male Pipe Thread



Body Size	Part No.	Thread Size	Length	Largest Diameter	Wrench Flats	Weight (lbs)
1/4	EZ-251-4MP	1/4-18 NPTF	2.85	1.00	0.75	0.30
1/4	EZ-251-6MP	3/8-18 NPTF	2.87	1.00	0.75	0.31
3/8	EZ-371-6MP	3/8-18 NPTF	3.10	1.18	0.88	0.44
1/2	EZ-501-8MP	1/2-14 NPTF	3.62	1.38	1.12	0.73
3/4	EZ-751-12MP	3/4-14 NPTF	4.04	1.57	1.38	0.90

Couplers - Standard Hose Barb



Body Size	Part No.	Hose I.D.	Length	Largest Diameter	Wrench Flats	Weight (lbs)
1/4	EZ-251-4HB	1/4	3.20	1.00	0.75	0.28
1/4	EZ-251-6HB	3/8	3.20	1.00	0.75	0.29
3/8	EZ-371-6HB	3/8	3.43	1.18	0.88	0.42
1/2	EZ-501-8HB	1/2	4.06	1.40	1.12	0.70

Couplers - Push-Lok Hose Barb*



Body Size	Part No.	Hose I.D.	Length	Largest Diameter	Wrench Flats	Weight (lbs)
1/4	EZ-251-4PL	1/4	3.03	1.00	0.75	0.28
1/4	EZ-251-6PL	3/8	3.18	1.00	0.75	0.29
3/8	EZ-371-6PL	3/8	3.38	1.18	0.88	0.42
1/2	EZ-501-8PL	1/2	3.91	1.38	1.12	0.70

* Push-Lok hose barbs are designed for use with Parker Push-Lok hose and do not require clamps.

WARNING: This product can expose you to chemicals including Lead, which is known to the State of California to cause cancer and birth defects or other reproductive harm. For more information go to www.P65Warnings.ca.gov



Pneumatic Quick Couplings

Special Purpose

GF Series

Natural & Propane Gas

Safety fuse nipple



A Pneumatics



GF/GF-1 Series couplings are valved on the coupler half and will automatically shut off gas flow when coupling is disconnected and automatically open on connection. They also incorporate a safety fuse in the nipple that will shut off the gas supply to your application in the event temperatures exceed 350°F.

Features:

- Superior flow capacity
- 60 psi max pressure rating
- 1/4" - 1-1/4" size range
- Certified to ANSI Z21-41-2011, CSA 6.9-2011 for use with natural, manufactured and mixed gases, liquefied petroleum gases and LP gas-air mixtures
- On-site CSA certified lab and qualified inspection personnel
- Fusible link internal to the nipple protects against gas-fed fires

Applications include:

- Small Gas Appliances



GF Specifications

Body Size	1/4	3/8	1/2	3/4	1	1-1/4
Flow Capacity*	24,300 Btu/hr	50,000 Btu/hr	99,600 Btu/hr	212,000 Btu/hr	378,000 Btu/hr	475,000 Btu/hr
Temperature Range: Standard GF/GF-1 (indoor use) temperature range: 32°F to 200°F. Contact QCD for low temperature version (outdoor use) temperature range: -40°F to 200°F						

*Based on a 1000 Btu per cubic foot gas with a specific gravity of 0.64 at a pressure drop of 0.3 in. w.c.

Couplers



Body Size	Part Number Brass	Port End	Length	Connected Length	Largest Diameter	Wrench Flats	Weight (lbs)
1/4	BVGFC4-4F	1/4-18 NPTF	1.64	2.41	0.96	0.88	0.194
3/8	BVGFC6-6F	3/8-18 NPTF	1.90	2.69	1.22	1.00	0.284
1/2	BVGF-1C8-8F	1/2-14 NPTF	2.47	3.39	1.42	1.00	0.326
3/4	BVGF-1C12-12F	3/4-14 NPTF	2.51	3.48	1.66	1.31	0.534
1	BVGFC16-16F	1-11-1/2 NPTF	2.69	3.91	2.03	1.88	1.150
1-1/4	BVGFC20-20F	1-1/4-11-1/2 NPTF	3.54	4.88	2.25	2.00	1.568

Nipples



Body Size	Part Number Brass	Port End	Length	Connected Length	Largest Diameter	Wrench Flats	Weight (lbs)
1/4	BPGFN4-4F	1/4-18 NPTF	1.32	2.41	0.69	0.62	0.052
3/8	BPGFN6-6F	3/8-18 NPTF	1.52	2.69	0.91	0.81	0.105
1/2	BPGF-1N8-8F	1/2-14 NPTF	1.55	3.39	1.13	1.00	0.154
3/4	BPGF-1N12-12F	3/4-14 NPTF	1.79	3.48	1.34	1.19	0.212
1	BPGFN16-16F	1-11-1/2 NPTF	2.10	3.91	1.65	1.50	0.380
1-1/4	BPGFN20-20F	1-1/4-11-1/2 NPTF	2.22	4.88	2.06	1.88	0.576



WARNING: This product can expose you to chemicals including Lead, which is known to the State of California to cause cancer and birth defects or other reproductive harm. For more information go to www.P65Warnings.ca.gov



Hydraulic Quick Couplings

Double Shut-Off and Straight-Thru Couplings

Parker hydraulic couplings have a wide variety of designs, each tailored to a particular application or use. This catalog is arranged according to those categories. In each section the construction of a specific design will be detailed. However, based on the valving of the coupling, hydraulic couplings generally fall into one of two groups, either Double Shut-Off or Straight-Thru.

Double Shut-Off couplings are used extensively when it is important to minimize fluid loss upon disconnection. Both halves of the coupler, the body and the nipple, contain shut-off valves. These valves open automatically when the body and nipple are connected, and close automatically when the two halves are disconnected—keeping fluid loss to a minimum.

Parker Straight-Thru couplings have no valves in either half and are ideal for maximum flow application. Their smooth, open bore offers the lowest pressure drop of any quick disconnect coupling, and allows them to be thoroughly cleaned. Since there are no valves in either half, fluid flow should be shut off before the coupling is disconnected.

Rated Pressure

Rated pressure for the Parker hydraulic couplings range from 30 to 15,000 psi, depending on the coupling series, size and materials. Rated pressures as shown in this catalog are defined by ISO 5598, as “the qualified operating pressures which are recommended for a component or a system by the manufacturer.” Parker “Rated Pressures” have been established on the basis of laboratory tests which include, but are not limited to, static burst tests and multiple cycle impulse tests. System characteristics such as high cycling rates and high amplitude shocks either hydraulic or mechanical, can reduce the functioning life of a coupling, even if the system’s nominal pressure falls within the rated pressure range of the coupling.

For assistance in analyzing your application, contact your nearest Parker sales office or the Quick Coupling Division in Minneapolis.

Refer to the Safety Guide at the end of this catalog for considerations when selecting a Quick Coupling.

Refer to the Fluid Compatibility Chart (note Table of Contents) for seal selection assistance for both Double Shut-Off and Straight-Thru couplings.

Checklist for Selecting Quick Couplings

- What are the functional requirements of the coupling?
- What is the maximum working pressure of the application?
- Which seals and body material are compatible with the system’s fluid?
- Is the application static or dynamic?
- What size coupler is required?
- What is the maximum pressure drop suitable for the application?
- Does the application require the ability to connect and disconnect under pressure?
- What is the media temperature and ambient temperature?
- What end configurations are required?
- Is an industry interchange coupler required?
- Is air inclusion and fluid loss a concern in the application?

Table of Contents

Introduction..... B-1

Coupling Selection & Ordering Guide B-4, 5, 98

General Purpose Couplings

60 Series B-6

Couplers..... B-8

Nipples B-9

60 Series Steam B-12

Couplers..... B-12

Nipples B-12

6600 Series B-13

Couplers..... B-14

Nipples B-14

H Series B-16

H Couplers B-19

H Nipples B-22

PH Couplers..... B-21

PH Nipples B-23

EA Series B-26

Couplers..... B-28

Nipples B-29

SM Series..... B-30

Couplers..... B-31

Nipples B-31

HP Series..... B-33

Couplers..... B-34

Nipples B-34

4000 Series B-35

Couplers..... B-36

Nipples B-36

4200 Series B-38

Couplers..... B-39

Nipples B-39

Non-Spill Couplings

NS Series..... B-40

Couplers..... B-41

Nipples B-41

NSS Series..... B-42

Couplers..... B-43

Nipples B-44

FF/FC Series..... B-46

Couplers..... B-47

Nipples B-47

FC Nipples..... B-49

FEM/FEC Series..... B-50

Couplers B-51

Nipples..... B-52

FEC Nipples B-53

FH Series..... B-54

Couplers B-55

Nipples..... B-55

FS Series B-56

Couplers B-57

Nipples..... B-57

Connect Under Pressure Couplings

59 Series B-59

Couplers..... B-60

Nipples B-60

FET Series B-61

Couplers..... B-62

Nipples B-63

6100 Series..... B-65

Couplers B-66

Nipples..... B-67

8200 Series..... B-68

Couplers B-69

Nipples..... B-69

9200 Series..... B-70

Couplers B-71

Nipples..... B-71

5000 Series..... B-72

Couplers B-73

Nipples..... B-73

75 Series B-74

Couplers..... B-76

Nipples B-76

High Pressure Couplings

71 Series B-77

Couplers..... B-79

Nipples B-80

3000 Series..... B-81

Couplers B-82

Nipples..... B-82

TC Series B-83

Couplers B-83

Nipples..... B-83

1141 Series..... B-84

Couplers B-84

Nipples..... B-84

High Flow Couplings

ST Series B-85

Couplers B-86

Nipples..... B-87

1163 Series..... B-88

Couplers B-88

Nipples..... B-88

H0 Series B-89

Couplers B-89

Nipples..... B-89

Mold Coolant Line Couplings

Moldmate Series..... B-90

Couplers B-91

Sub Assemblies & Replacement Parts..... B-92

Nipples..... B-94

Miniature

DM Series..... B-96

Couplers B-97

Nipples..... B-97

Table of Contents

SensoControl Diagnostic and Industrial Catalogs.....	B-99
Diagnostic Test Port Couplings.....	B-99
Test Port Couplings.....	B-100
PD Series.....	B-100
Dust Cap.....	B-100
Couplers.....	B-101
Nipples.....	B-101
PDP Series.....	B-104
Dust Cap.....	B-104
Couplers.....	B-105
Nipples.....	B-105
EMA3 Series.....	B-106
Nipples.....	B-107
Gauge Adapters & Union.....	B-107
Transducer Adapters.....	B-108
Flexible Hose.....	B-108
PDFS Series - Fluid Sampling.....	B-109
Couplers.....	B-109
Nipples.....	B-109
Probe.....	B-109
Promotional Products-Keychains.....	B-111

Hydraulic Coupling Selection Guide

Body Sizes (in.)	Valving Style	Material						Locking Style	Std Seal Material*	Std Seal Temp Range	Rated Pressure	Coupling Series	
		A	B	S	S3	S6	HP						TP
General Purpose													
1/8 to 2-1/2	Poppet		■	■	■	■			Ball	Nitrile	-40° to +250° F	800-5000 psi	60 Series
1/4 to 1	Poppet		■						Ball	Ethylene Propylene	-65° to +400° F		60 Series (steam)
1/4 to 1	Poppet		■	■					Ball	Nitrile	-40° to +250° F	4000-5000 psi	6600 Series
1/4 to 4	Poppet/Unvalved	■	■	■		■			Ball	Nitrile	-40° to +250° F	150 - 11000 psi	H Series
1/4 to 3/4	Valved/Unvalved		■	■		■			Ball	Nitrile	-40° to +250° F	vacuum - 3000 psi	EA Series
1/4 to 3/4	Poppet		■	■					Ball	Nitrile	-40° to +250° F	4500-6000 psi	SM Series
1 to 1-1/2	Poppet		■	■					Ball	Nitrile	-40° to +250° F	5000 psi	HP Series
1/4 to 1	Poppet/Ball		■	■					Ball	Nitrile	-40° to +250° F	3000 psi	4000 Series
3/8 to 1/2	Poppet/Ball		■	■					Ball	Nitrile	-40° to +250° F	3000 psi	4200 Series
Non-Spill													
3/8 to 1/2	Flush Face		■			■			Ball	Ethylene Propylene	-70° to +250° F	300 psi	NSS Series
3/8 to 1	Flush Face		■	■					Ball	Nitrile	-40° to +250° F	2500 psi	NS Series
1/2	Flush Face/Pop-pet		■	■					Ball	Nitrile/Polyurethane	-40° to +250° F	3000-3625 psi	EAS/SAE Adapters
1/4 to 1	Flush Face		■	■					Ball	Nitrile/Polyurethane	-40° to +250° F	3000-5000 psi	FF Series
1/4 to 1	Flush Face		■	■					Ball	Nitrile/Polyurethane	-40° to +250° F	3000-5000 psi	FEM Series
1/4 to 1	Flush Face		■			■			Ball	Fluorocarbon	-15° to +400° F	2000 psi	FS Series
1/2 to 2	Flush Face		■					■	Pawl	Fluorocarbon	+40° to +140° F	30-100 psi	PF Series
Non-Spill Connect Under Pressure													
3/8 to 1-1/2	Flush Face		■	■					Acme Threads	Nitrile/Polyurethane	-40° to +250° F	5000-6000 psi	59 Series
3/8 to 2	Flush Face		■	■					Threads	Nitrile/Polyurethane	-40° to +250° F	5000-6000 psi	FET Series
3/8 to 3/4	Flush Face		■	■					Ball	Nitrile/Polyurethane	-40° to +250° F	3000 psi	FC Series
1/2 to 3/4	Flush Face		■	■					Ball	Nitrile/Polyurethane	-40° to +250° F	3000 psi	FEC Series
3/4 to 1-1/2	Flush Face		■	■					Threads	Nitrile	-20° to +200° F	2000-3000 psi	6100 Series
Connect Under Pressure													
1/2	Poppet		■	■					Ball	Nitrile	-40° to +250° F	3000 psi	8200 Series
1/2	Poppet		■	■					Ball	Nitrile	-40° to +250° F	3000 psi	9200 Series
1/2	Ball		■	■					Threads	Nitrile	-40° to +250° F	2500 psi	5000 Series
3/4 to 4	Poppet		■	■		■			Threads	Nitrile	-40° to +250° F	5000 psi	75 Series
High Pressure													
1/4 to 2	Flush Face		■	■		■	■		Ball	Nitrile	-40° to +250° F	10,000 psi	71 Series
3/8	Flush Face		■	■					Ball	Nitrile	-40° to +250° F	10,000 psi	FH Series
1/4 to 3/8	Ball		■	■					Threads	Polyurethane	-22° to +230° F	10,000 psi	3000 Series
3/8	Poppet		■	■					Ball	Fluorocarbon	-15° to +400° F	10,000 psi	TC Series
1/4	Poppet		■	■		■			Threads	Polyurethane	-30° to +180° F	10,000 psi	1141 Series
High Flow													
1/8 to 1-1/2	Unvalved		■	■	■				Ball	Nitrile	-40° to +250° F	2500-6700 psi	ST Series
1/4 to 1/2	Unvalved		■	■					Ball	Nitrile	-40° to +250° F	10,000-15,000 psi	H0 Series
3/4	Unvalved		■	■					Ball	Nitrile	-40° to +250° F	200 psi	1163 Series
Mold Coolant													
1/4 to 1/2	Valved/Unvalved		■	■					Ball	Silicone	-20° to +400° F	200 psi	Moldmate
Miniature													
1/8	Poppet		■	■					Ball	Fluorocarbon	-15° to +400° F	250 psi	DM Series

Materials: A - Aluminum B - Brass S - Steel S3 - 303 Stainless S6 - 316 Stainless HP - High Pressure Stainless Steel TP - Thermoplastic



B Hydraulics

*Seal Material Options

Seal Code	Seal Material	Optional for the Following Series
W	Ethylene Propylene	60, 6600, 4000, 4200, 6100, 5000, 8200, 9200, ST
Y	Fluorocarbon	60, 6600, 4000, 4200, 6100, 5000, 8200, 9200, ST, Moldmate
Z	Neoprene	60, 6600, 4000, 4200, 6100, 5000, 8200, 9200, ST
E5	Ethylene Propylene	SM, HP, NS, FF, FEM, FH, FS, HO
E4	Fluorocarbon	SM, HP, NS, FF, FEM, FH, HO
E12	Neoprene	SM, HP, NS, FF, FEM, FH, FS, HO
E35	Perfluoroelastomer	SM, HP, NS, FF, FEM, FH, FS (Contact QCD)
E	Ethylene Propylene	H, EA, 71, 75
V	Fluorocarbon	H, EA, 71, 75

To select proper seal materials, see Fluid Compatibility Chart or contact QCD.
Contact QCD for additional seal material options.





60 Series double shut-off couplings are versatile for use across a spectrum of hydraulic applications where fluid lines require connection and disconnection. Couplers and nipples are available in a wide range of sizes and materials.

Features:

- Accepts ISO 7241-1, Series B compliant nipples
- Poppet valves along with a metal to metal valve stop maintains valve alignment and prevents flow checking
- Steel, brass, and stainless steel material options
- Brass couplers have double O-rings and stainless steel locking balls
- Steel coupler sleeve and steel nipple body are hardened to be wear resistant
- Standard end configurations include female pipe and straight thread ORB
- Optional Sleeve-Lok and alternative seal materials available

Applications include:

- Industrial hydraulic lines
- Food and chemical processing
- Water and coolant lines
- Mobile equipment
- May be used with some gases

General Purpose Specifications

Industry Standard: Parker 60 Series couplings comply with ISO 7241 Series B Standard.

ANSI/ISO Pressure Rating: Dynamic applications with normal to moderate hydraulic shocks such as general industrial equipment, hydraulic presses, agricultural equipment, etc. Impulse tested at a multiple (125% to 133%) of rated pressure.

Low Cycle, Non-pulsating Pressure Rating: Applications with lower cycle life and no severe cyclic pressure fluctuations, essentially steady pressure during an operating cycle. Typical applications include hydraulic jacks, mine roof support systems, and high pressure fluid transfer (pumping water or slurry in oil wells). Minor pump ripple is considered non-pulsating. Impulse tested at rated pressure.

Body Size	1/8	1/4	3/8	1/2	3/4	1	1 1/2	2 1/2	1/8	1/4	3/8	1/2	3/4	1	1 1/2	2 1/2
	Rated Pressure (psi)								Rated Pressure (psi)							
Brass	1000	1000	1000	1000	1000	1000	800	800	3000	3700	2700	3500	2200	1500	1500	1200
Stainless steel	2000	2000	1500	1500	1500	1000	1000	1000	5000	5000	5000	5000	3000	3000	1500	1500
Steel	5000	5000	4000	4000	2500	2000	1000	1000	5000	5000	4000	4000	2500	2000	1500	1500
Steel w/ HD nipple	N/A	5000	4000	4000	3000	3000	N/A	N/A	5000	5000	4000	4000	3000	3000	N/A	N/A

Seal Temperature Range: **Nitrile:** -40°F to +250°F (Standard seal for Brass, Steel, & 303 Stainless Steel couplings).

Fluorocarbon: -15°F to +400°F (Standard seal for 316 Stainless Steel couplings).

Other Seal materials: Contact the Division for availability.

Vacuum Data: 27.4 inches Hg (-0.9 Bar) both connected and disconnected. (1-1/2" and 2-1/2" body size 60 Series couplings are not recommended for service in disconnected mode)

Body Size	1/8	1/4	3/8	1/2	3/4	1	1 1/2	2 1/2
Rated Flow (gpm)	.8	3	6	12	28	50	100	200



Performance

60 Series (1/8" & 1/4")
Test Fluid: Oil - 150 SUS

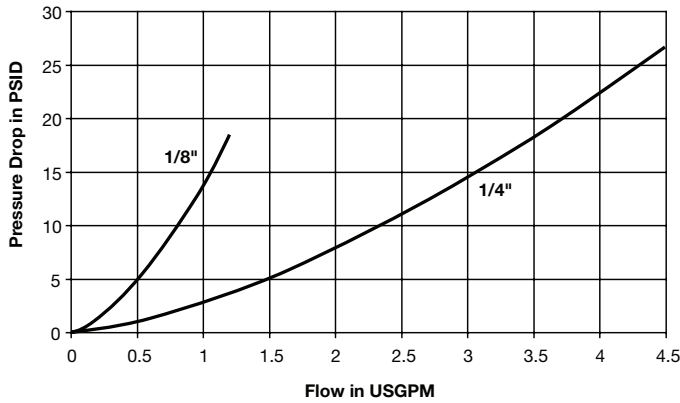

60 Series (3/8" & 1/2")
Test Fluid: Oil - 150 SUS

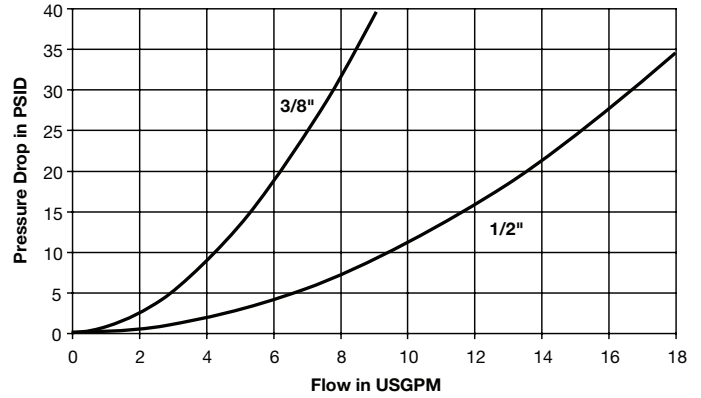

60 Series (3/4" & 1")
Test Fluid: Oil - 150 SUS

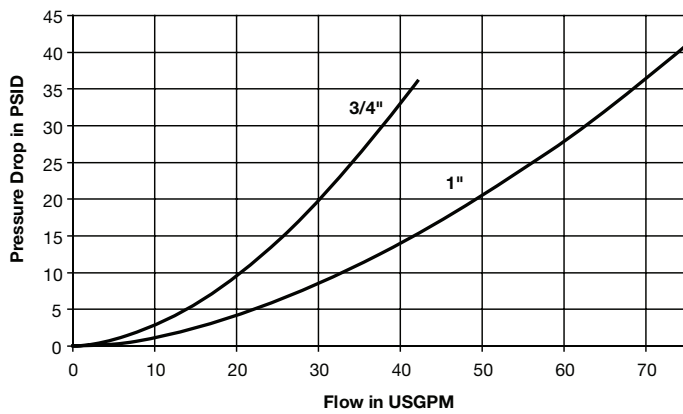

60 Series (1-1/2" & 2-1/2")
Test Fluid: Oil - 200 SUS

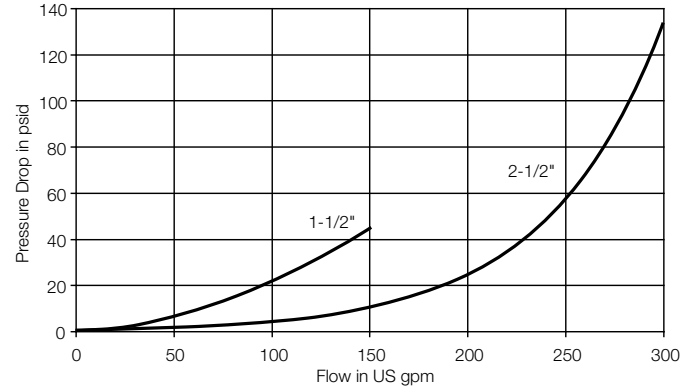

Optional Materials and Features:

(add code to part number)

Code	Description	Part Number Example
suffix -VA	Valve actuator (Nipples)	H3-63-VA
suffix -SL	Sleeve-Lok (Couplers)	H3-62-SL
prefix HD	Heavy duty (Steel Nipples)	HDH3-63
suffix W	Ethylene Propylene seal material (EPR)	H3-63W
suffix Y	Fluorocarbon seal material	H3-62Y
suffix Z	Neoprene seal material	H3-63Z

Contact QCD for availability and additional options.
To select proper seal materials, see Fluid Compatibility Chart or contact QCD.



Couplers - Brass, Steel, 303 Stainless - Female Thread



Body Size	Part No. Brass	Weight (lbs.)	Part No. Steel	Weight (lbs.)	Part No. Type 303 Stainless**	Weight (lbs.)	Thread Size	Overall Length	Wrench Flats	Largest Dia
1/8	BH1-60	0.16	H1-62	0.16	SH1-62	0.16	1/8-27 NPTF	1.90	0.68	0.96
1/8	-	-	H1-62-T4	0.18	SH1-62-T4	0.10	7/16-20 ORB	2.06	0.68	0.96
1/4	BH2-60	0.32	H2-62	0.30	SH2-62	0.30	1/4-18 NPTF	2.26	0.81	1.14
1/4	-	-	H2-62-T6	0.31	SH2-62-T6	0.31	9/16-18 ORB	2.41	0.81	1.14
3/8	BH3-60	0.43	H3-62	0.40	SH3-62	0.40	3/8-18 NPTF	2.49	0.88	1.40
3/8	-	-	H3-62-T8	0.51	SH3-62-T8	0.51	3/4-16 ORB	2.75	1.00	1.40
1/2	BH4-60	0.80	H4-62	0.73	SH4-62	0.75	1/2-14 NPTF	2.87	1.12	1.77
1/2	-	-	H4-62-T10	0.78	SH4-62-T10	0.75	7/8-14 ORB	3.05	1.12	1.77
3/4	BH6-60	1.31	H6-62	1.30	SH6-62	1.31	3/4-14 NPTF	3.56	1.31	2.14
3/4	-	-	H6-62-T12	1.39	SH6-62-T12	1.34	1-1/16 - 12 ORB	3.56	1.31	2.14
1	BH8-60	1.95	H8-62	1.95	SH8-62	1.95	1 - 11 1/2 NPTF	4.18	1.62	2.52
1	-	-	H8-62-T16	1.95	SH8-62-T16	1.95	1-5/16 - 12 ORB	4.18	1.62	2.52

Couplers - Brass, Steel, 303 Stainless - Female Thread



Body Size	Part No. Brass	Weight (lbs.)	Part No. Steel	Weight (lbs.)	Part No. Type 303 Stainless**	Weight (lbs.)	Thread Size	Overall Length	Wrench Flats	Largest Dia
1-1/2	BH12-60L	4.58	H12-62L	4.70	SH12-62L	4.68	1-1/4 - 11 1/2 NPTF	4.86	2.38*	3.00
1-1/2	BH12-60N	4.58	H12-62N	4.70	SH12-62N	4.68	1-1/2 - 11 1/2 NPTF	4.86	2.38*	3.00
1-1/2	-	4.61	H12-62-T20	4.72	SH12-62-T20	4.71	1-5/8 - 12 ORB	4.86	2.38*	3.00
1-1/2	-	4.61	H12-62-T24	4.72	SH12-62-T24	4.71	1-7/8 - 12 ORB	4.86	2.38*	3.00
2-1/2	BH2016-60	11.06	H2016-62	10.58	SH2016-62	-	2 - 11 1/2 NPTF	5.57	3.75	4.10
2-1/2	BH2020-60	11.42	H2020-62	10.91	SH2020-62	-	2 1/2 - 8 NPTF	6.04	3.75	4.10
2-1/2	BH2024-60	-	H2024-62	-	SH2024-62	-	3 - 8 NPTF	6.69	4.00	4.35

* Wrench Flat on 303 Stainless is 2.50 in.

** Prop 65 Warning does not apply to stainless steel part numbers



WARNING: This product can expose you to chemicals including Lead, which is known to the State of California to cause cancer and birth defects or other reproductive harm. For more information go to www.P65Warnings.ca.gov



Couplers and Nipples - 316 Stainless - Female Thread



Body Size	Coupler Part No. Type 316 Stainless**	Weight (lbs.)	Thread Size	Overall Length	Wrench Flats	Largest Dia	Nipple Part No. Type 316 Stainless**	Weight (lbs.)	Overall Length	Exposed Length*	Wrench Flats	Largest Dia
1/8	SSH1-62Y	0.15	1/8-27 NPT	1.90	0.68	0.96	SSH1-63Y	0.04	1.26	0.44	0.56	0.65
1/8	SSH1-62Y-T4	0.17	7/16-20 ORB	2.06	0.68	0.96	SSH1-63Y-T4	0.06	1.41	0.59	0.69	0.78
1/4	SSH2-62Y	0.30	1/4-18 NPT	2.26	0.81	1.14	SSH2-63Y	0.08	1.54	0.55	0.75	0.87
1/4	SSH2-62Y-T6	0.31	9/16-18 ORB	2.41	0.81	1.14	SSH2-63Y-T6	0.10	1.69	0.70	0.88	1.01
3/8	SSH3-62Y	0.40	3/8-18 NPT	2.49	0.88	1.40	SSH3-63Y	0.12	1.68	0.54	0.88	1.01
3/8	SSH3-62Y-T8	0.51	3/4-16 ORB	2.75	1.00	1.40	SSH3-63Y-T8	0.14	1.94	0.80	1.00	1.15
1/2	SSH4-62Y	0.76	1/2-14 NPT	2.87	1.12	1.77	SSH4-63Y	0.24	1.94	0.69	1.12	1.30
1/2	SSH4-62Y-T10	0.78	7/8-14 ORB	3.05	1.12	1.77	SSH4-63Y-T10	0.27	2.12	0.87	1.19	1.37
3/4	SSH6-62Y	1.33	3/4-14 NPT	3.56	1.31	2.14	SSH6-63Y	0.46	2.43	0.79	1.38	1.59
3/4	SSH6-62Y-T12	1.40	1-1/16 - 12 ORB	3.56	1.31	2.14	SSH6-63Y-T12	0.50	2.54	0.90	1.34	1.59
1	SSH8-62Y	1.95	1 - 11 1/2 NPT	4.18	1.62	2.52	SSH8-63Y	0.76	2.91	0.99	1.62	1.88
1	SSH8-62Y-T16	1.95	1-5/16 - 12 ORB	4.18	1.62	2.52	SSH8-63Y-T16	0.80	2.91	0.99	1.62	1.88
1-1/2	SSH12-62LY	4.68	1-1/4 - 11 1/2 NPT	4.86	2.38*	3.00	SSH12-63LY	-	4.76	2.69	2.38‡	2.75†
1-1/2	SSH12-62NY	4.68	1-1/2 - 11 1/2 NPT	4.86	2.38*	3.00	SSH12-63NY	-	4.76	2.69	2.38‡	2.75†
1-1/2	SSH12-62Y-T20	4.71	1-5/8 - 12 ORB	4.86	2.38*	3.00	SSH12-63Y-T20	-	4.76	2.69	2.38‡	2.75†
1-1/2	SSH12-62Y-T24	4.71	1-7/8 - 12 ORB	4.86	2.38*	3.00	SSH12-63Y-T24	-	4.76	2.69	2.38‡	2.75†
2-1/2	SSH2016-62Y	-	2 - 11 1/2 NPT	5.57	3.75	4.10	SSH2016-63Y	-	5.48	2.90	3.75	4.10
2-1/2	SSH2020-62Y	-	2 1/2 - 8 NPT	6.04	3.75	4.10	SSH2020-63Y	-	5.95	3.37	3.75	4.10
2-1/2	SSH2024-62Y	-	3 - 8 NPT	6.69	4.00	4.35	SSH2024-63Y	-	6.87	4.29	4.00	4.35

* This dimension represents the portion that is exposed when the nipple is inserted into the mating Parker Coupler.

** Prop 65 Warning does not apply to stainless steel part numbers



Nipples - Brass, Steel, 303 Stainless - Female Thread



Body Size	Part No. Brass	Weight (lbs.)	Part No. Steel	Weight (lbs.)	Part No. Type 303 Stainless**	Weight (lbs.)	Thread Size	Overall Length	Exposed Length*	Wrench Flats	Largest Dia
1/8	BH1-61	0.04	H1-63	0.03	SH1-63	0.03	1/8-27 NPTF	1.26	0.44	0.56	0.65
1/8	-	0.06	H1-63-T4	0.05	SH1-63-T4	-	7/16-20 ORB	1.41	0.59	0.69	0.78
1/4	BH2-61	0.09	H2-63	0.08	SH2-63	0.08	1/4-18 NPTF	1.54	0.55	0.75	0.87
1/4	-	0.11	H2-63-T6	0.10	SH2-63-T6	0.10	9/16-18 ORB	1.69	0.70	0.88	1.01
3/8	BH3-61	0.10	H3-63	0.12	SH3-63	0.12	3/8-18 NPTF	1.68	0.54	0.88	1.01
3/8	-	0.12	H3-63-T8	0.16	SH3-63-T8	0.16	3/4-16 ORB	1.94	0.80	1.00	1.15
1/2	BH4-61	0.25	H4-63	0.24	SH4-63	0.24	1/2-14 NPTF	1.94	0.69	1.12	1.30
1/2	-	0.28	H4-63-T10	0.27	SH4-63-T10	0.27	7/8-14 ORB	2.12	0.87	1.19	1.37
3/4	BH6-61	0.50	H6-63	0.46	SH6-63	0.45	3/4-14 NPTF	2.43	0.79	1.38	1.59
3/4	-	0.55	H6-63-T12	0.46	SH6-63-T12	0.50	1-1/16 - 12 ORB	2.54	0.90	1.34	1.59
1	BH8-61	0.76	H8-63	0.76	SH8-63	0.76	1 - 11 1/2 NPTF	2.91	0.99	1.62	1.88
1	-	0.80	H8-63-T16	0.80	SH8-63-T16	0.80	1-5/16 - 12 ORB	2.91	0.99	1.62	1.88

* This dimension represents the portion that is exposed when the nipple is inserted into the mating Parker Coupler.

Nipples - Brass, Steel, 303 Stainless - Female Thread



Body Size	Part No. Brass	Weight (lbs.)	Part No. Steel	Weight (lbs.)	Part No. Type 303 Stainless**	Weight (lbs.)	Thread Size	Overall Length	Exposed Length*	Wrench Flats	Largest Dia
1-1/2	BH12-61L	2.96	H12-63L	3.10	SH12-63L	3.06	1-1/4 - 11 1/2 NPTF	4.76	2.69	2.38‡	2.75†
1-1/2	BH12-61N	2.96	H12-63N	3.10	SH12-63N	3.06	1-1/2 - 11 1/2 NPTF	4.76	2.69	2.38‡	2.75†
1-1/2	-	-	H12-63-T20	3.15	SH12-63-T20	3.14	1-5/8 - 12 ORB	4.76	2.69	2.38‡	2.75†
1-1/2	-	-	H12-63-T24	3.15	SH12-63-T24	3.14	1-7/8 - 12 ORB	4.76	2.69	2.38‡	2.75†
2-1/2	BH2016-61	7.78	H2016-63	7.90	SH2016-63	7.92	2 - 11 1/2 NPTF	5.48	2.90	3.75	4.10
2-1/2	BH2020-61	8.12	H2020-63	8.16	SH2020-63	8.16	2-1/2 - 8 NPTF	5.95	3.37	3.75	4.10
2-1/2	BH2024-61	-	H2024-63	-	SH2024-63	-	3 - 8 NPTF	6.87	4.29	4.00	4.35

* This dimension represents the portion that is exposed when the nipple is inserted into the mating Parker Coupler.

† Largest diameter on Brass is 2.96" across Hex Corners

‡ Hex on 303 Stainless is 2.50 in.

** Prop 65 Warning does not apply to stainless steel part numbers



WARNING: This product can expose you to chemicals including Lead, which is known to the State of California to cause cancer and birth defects or other reproductive harm. For more information go to www.P65Warnings.ca.gov



Replacement Parts		
60 Series Couplers		
Body Size	O-Rings - Nitrile	Back-Up Rings
1/8	50001-013-0010	H67A-28
1/4	50001-015-0010	H67C-28
3/8	50001-116-0010	4118007
1/2	50001-213-0010	4128002
3/4	50001-218-0010	4148001
1	50001-222-0010	4158001
1-1/2	50001-124-0010 (Valve)	
1-1/2	50001-138-0260 (Fitting)	
1-1/2	50001-224-0010 (Body 2 req.)	
2-1/2	50001-133-0010 (Valve)	
2-1/2	50001-234-0260 (Fitting)	
2-1/2	50001-333-0010 (Body)	

Repair Kits				
Couplers			Nipples	
Body Size	Repair Kit Part No.	Used for Part No.	Repair Kit Part No.	Used for Part No.
3/8	H67E-62K	H3-62	H67E-63K	H3-63
3/8	BH67E-60K	BH3-60	BH67E-61K	BH3-61
3/8	SH67E-62K	SH3-62	SH67E-63K	SH3-63
3/8	SSH67E-62KY	SSH3-62Y	SSH67E-63KY	SSH3-63Y
1/2	H67F-62K	H4-62	H67F-63K	H4-63
1/2	BH67F-60K	BH4-60	BH67F-61K	BH4-61
1/2	SH67F-62K	SH4-62	SH67F-63K	SH4-63
1/2	SSH67F-62KY	SSH4-62Y	SSH67F-63KY	SSH4-63Y
3/4	H67G-62K	H6-62	H67G-63K	H6-63
3/4	BH67G-60K	BH6-60	BH67G-61K	BH6-61
3/4	SH67G-62K	SH6-62	SH67G-63K	SH6-63
3/4	SSH67G-62KY	SSH6-62Y	SSH67G-63KY	SSH6-63Y
1	H67J-62K	H8-62	H67J-63K	H8-63
1	BH67J-60K	BH8-60	BH67J-61K	BH8-61
1	SH67J-62K	SH8-62	SH67J-63K	SH8-63
1	SSH67J-62KY	SSH8-62Y	SSH67J-63KY	SSH8-63Y

60 Series Dust Plugs and Caps				
Body Size	Coupler Dust Plug Aluminum	Coupler Dust Plug Rubber	Nipple Dust Cap Aluminum	Nipple Dust Cap Rubber
1/8	H1-65	H1-65M	H1-66	H1-66M
1/4	H2-65	H2-65M	H2-66	H2-66M
3/8	H3-65	H3-65M	H3-66	H3-66M
1/2	H4-65	H4-65M	H4-66	H4-66M
3/4	H6-65	H6-65M	H6-66	H6-66M
1	H8-65	H8-65M	H8-66	H8-66M
1-1/2	H12-65	-	H12-66	-
2-1/2	H20P-65	-	H20P-66	-



Hydraulic Quick Couplings

General Purpose

60 Series (Steam)

ISO 7241, Series B

Manual sleeve, EP seal



60 Series Steam couplings are brass with stainless steel locking balls and ethylene propylene seals to withstand temperatures up to 400 F. 1/4 to 1 inch body sizes. 3/8 inch size couplers have a grip-ring sleeve.

Features:

- Accepts ISO 7241-1, Series B compliant nipples
- Poppet valves along with a metal to metal valve stop maintains valve alignment and prevents flow checking
- Brass couplers have double O-rings and stainless steel locking balls
- Standard end configuration is female pipe thread

Applications:

- Steam systems
- Cleaning equipment

Specifications

Body Size	1/4 to 1
Standard Seal Material	Ethylene Propylene
Temperature Range	up to +400°

Repair Kits - Steam Coupling

Body Size	Repair Kit Part No.	Used for Part No.
3/8	H68E-67K	H3-68
3/8	H69E-67K	H3-69

Couplers - Female Pipe Thread



H3-68 has grip-ring sleeve

Body Size	Part No. Brass	Thread Size	Length	Largest Diameter	Wrench Flats	Weight (lbs.)
1/4	BH2-60-STM	1/4-18 NPTF	2.26	1.14	0.81	0.30
3/8*	H3-68	3/8-18 NPTF	2.50	1.77	0.88	0.50
1/2	BH4-60-STM	1/2-14 NPTF	2.87	1.77	1.12	0.75
3/4	BH6-60-STM	3/4-14 NPTF	3.56	2.14	1.31	1.31
1	BH8-60-STM	1-11 1/2 NPTF	4.18	2.52	1.62	1.95

* See Photo for 3/8 inch size coupler configuration.

Nipples - Female Pipe Thread



Body Size	Part No. Brass	Thread Size	Overall Length	Exposed* Length	Largest Diameter	Wrench Flats	Weight (lbs.)
1/4	BH2-61-STM	1/4 - 18 NPTF	1.54	0.65	0.87	0.75	0.08
3/8	H3-69	3/8 - 18 NPTF	1.68	0.52	1.01	0.88	0.13
1/2	BH4-61-STM	1/2 - 14 NPTF	1.94	0.69	1.30	1.12	0.24
3/4	BH6-61-STM	3/4 - 14 NPTF	2.43	0.79	1.59	1.38	0.46
1	BH8-61-STM	1 - 11 1/2 NPTF	2.91	0.99	1.88	1.62	0.76

* This dimension represents the portion that is exposed when the nipple is inserted into the mating Parker Coupler.

WARNING: This product can expose you to chemicals including Lead, which is known to the State of California to cause cancer and birth defects or other reproductive harm. For more information go to www.P65Warnings.ca.gov



Hydraulic Quick Couplings General Purpose

6600 Series ISO 7241 Series A Manual sleeve, poppet valve



The 6600 Series are versatile for use in a wide range of hydraulic applications where fluid lines require connection and disconnection for equipment operation or maintenance

Features:

- Accepts ISO 7241-1, Series A compliant nipples
- Poppet valves and a metal perch to maintain valve alignment and prevent flow checking
- Coupler sleeve and nipple body are hardened to be damage resistant
- Standard end configurations include female pipe and straight thread ORB
- Protective zinc plating with clear trivalent chromate finish

Applications include:

- Truck trailer connections
- Mobile applications
- Attachments

6600 Series Specifications:

Body Size	Rated Flow (gpm)	Rated Pressure (psi)	Temperature	Body Material	Sleeve Type	Seal Material
1/4	0.8	5000	-40° F to +250° F	Steel	Manual Connect	Nitrile
3/8	6	4000				
1/2	12	4000				
3/4	28	4000				
1	50	4000				

Performance:

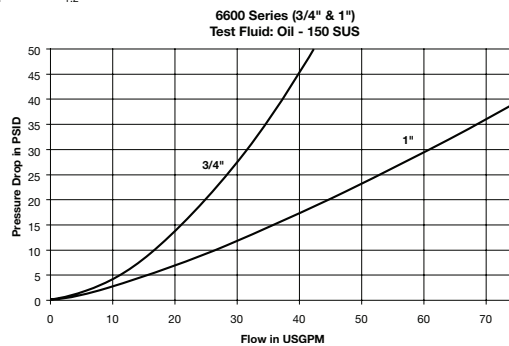
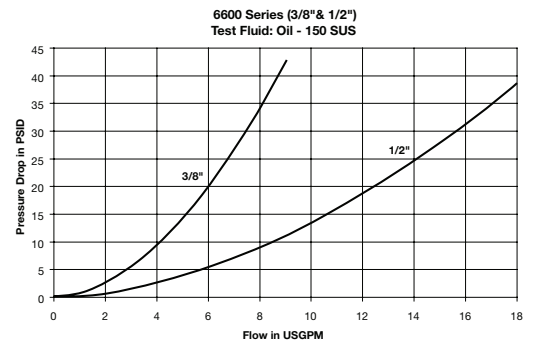
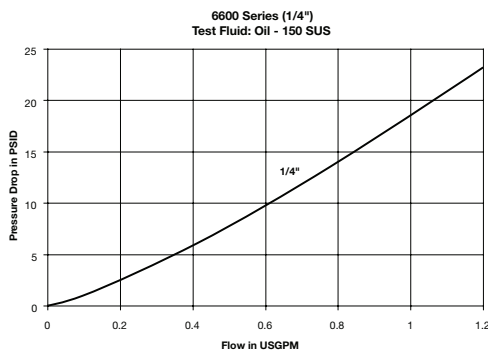



6600 Series Couplers



Body Size	Coupler Part Number	Port End	Valve Type	Length	Largest Diameter	Wrench Flats	Weight (lbs.)
1/4	6601-2-4	1/8-27 NPTF	Poppet	1.85	1.08	0.88	0.27
1/4	6601-4-4	1/4-18 NPTF	Poppet	1.85	1.08	0.88	0.26
3/8	6601-6-6	3/8-18 NPTF	Poppet	2.18	1.27	1.06	0.39
3/8	6608-6-6	9/16-18 ORB	Poppet	2.18	1.27	1.06	0.38
1/2	6601-8-10	1/2-14 NPTF	Poppet	2.75	1.52	1.25	0.67
1/2	6601-12-10	3/4-14 NPTF	Poppet	2.88	1.52	1.38	0.71
1/2	6608-8-10	3/4-16 ORB	Poppet	2.74	1.52	1.25	0.67
1/2	6608-10-10	7/8-14 ORB	Poppet	2.79	1.52	1.25	0.64
1/2	6608-12-10	1 1/16-12 ORB	Poppet	3.01	1.52	1.38	0.77
3/4	6601-12-12	3/4-14 NPTF	Poppet	3.36	1.90	1.62	1.31
3/4	6608-12-12	1 1/16-12 ORB	Poppet	3.35	1.90	1.62	1.31
1	6601-16-16	1-11 1/2 NPTF	Poppet	4.11	2.14	1.88	1.93
1	6608-16-16	1 5/16-12 ORB	Poppet	4.11	2.14	1.88	1.75

6600 Series Nipples



Body Size	Nipple Part Number	Port End	Valve Type	Length	Exposed Length*	Largest Diameter	Wrench Flats	Weight (lbs.)
1/4	6602-2-4	1/8-27 NPTF	Poppet	1.41	0.50	0.65	0.56	0.05
1/4	6602-4-4	1/4-18 NPTF	Poppet	1.41	0.58	0.87	0.75	0.07
3/8	6602-6-6	3/8-18 NPTF	Poppet	1.63	0.72	1.01	0.88	0.11
3/8	6610-6-6	9/16-18 ORB	Poppet	1.63	0.72	1.01	0.88	0.13
1/2	6602-8-10	1/2-14 NPTF	Poppet	2.08	0.78	1.23	1.06	0.21
1/2	6602-12-10	3/4-14 NPTF	Poppet	2.30	0.78	1.59	1.38	0.33
1/2	6610-8-10	3/4-16 ORB	Poppet	2.08	0.76	1.23	1.06	0.22
1/2	6610-10-10	7/8-14 ORB	Poppet	2.08	0.82	1.30	1.12	0.21
1/2	6610-12-10	1 1/16-12 ORB	Poppet	2.30	1.04	1.59	1.38	0.33
3/4	6602-12-12	3/4-14 NPTF	Poppet	2.55	1.18	1.59	1.38	0.49
3/4	6610-12-12	1 1/16-12 ORB	Poppet	2.55	1.18	1.59	1.38	0.47
1	6602-16-16	1-11 1/2 NPTF	Poppet	3.10	1.34	1.88	1.62	0.75
1	6610-16-16	1-5/16-12 ORB	Poppet	3.10	1.34	2.17	1.62	0.72

* This dimension represents the portion of the nipple that is exposed when the nipple and coupler are connected.



WARNING: This product can expose you to chemicals including Lead, which is known to the State of California to cause cancer and birth defects or other reproductive harm. For more information go to www.P65Warnings.ca.gov

6600 Series Replacement Parts	1/4	3/8	1/2	3/4	1
O-Rings - Nitrile	50001-112-0010	50001-115-0010	50001-211-0010	50001-123-0010	50001-126-0010
Back-up Rings	4118006	4118005	50-140-4	4138001	4148002



6600 Series Dust Caps and Plugs



Body Size	Dust Plug (Coupler)	Color/Material	Dust Cap (Nipple)	Weight (lbs.)
1/4	H1-65M	Black Rubber	H1-66M	.02
3/8	TR-37	Black Rubber	TR-37	.04
1/2	5205-4M	Black Rubber	5209-4M	.04
3/4	6659-12M	Black Rubber	6657-12M	.06
1	6659-16M	Black Rubber	6657-16M	.08

Optional Materials and Features:

(add code to part number)

Code	Description	Part Number Example
suffix -SL	Sleeve-Lok (Couplers)	6601-6-6-SL
suffix W	Ethylene Propylene seal material (EPR)	6601-6-6W
suffix Y	Fluorocarbon seal material	6601-6-6Y
suffix Z	Neoprene seal material	6601-6-6Z

Contact QCD for availability and additional options.
To select proper seal materials, see Fluid Compatibility Chart or contact QCD.



H Series, original Snap-tite design couplings have been proven by years of use on hydraulic applications.

H Series is best suited for general purpose fluid applications where either single or double shut-off valving is desired. A wide range of sizes, materials and end configurations are available.

PH version couplers and nipples are valved with a connect-under-pressure feature. These steel couplers and nipples allow connection with H Series valved couplers and nipples when there is a residual pressure on the PH coupler/nipple side. It is recommended that only one half of the connection (coupler or nipple) be PH version, not both.

Features:

- Sizes 1/4" - 4"
- Available in steel, brass, aluminum and 316 stainless steel
- Standard seal material is nitrile with other options available
- Optional sleeve lock helps to prevent accidental disconnection
- Double-shut-off version has low pressure drop
- Manually operated sleeve provides secure connection
- Designed to MIL-C 51234

Applications include:

- Industrial hydraulic lines
- Water and coolant lines
- Mobile equipment

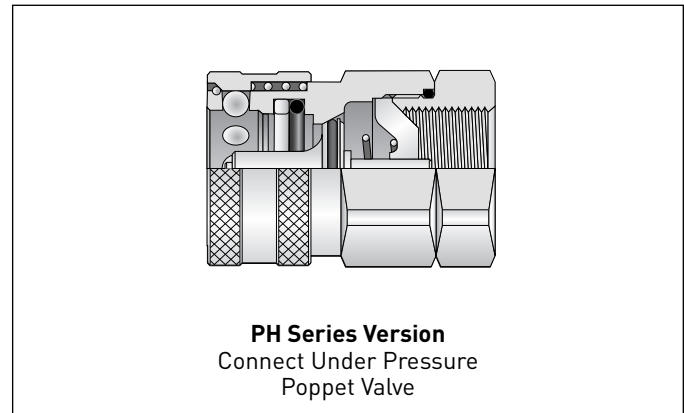
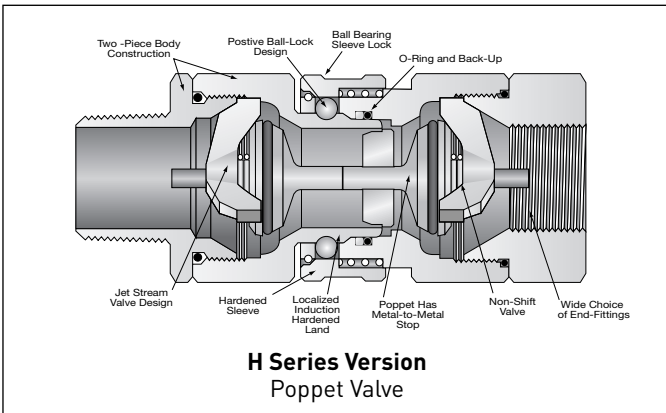

H & PH Series Working Pressures (psi)

Valved on both coupler and nipple (Double Shut-off)

Valved on one half and Unvalved/Plain on other half (Single Shut-off)

Body Size	1/4	3/8	1/2	3/4	1	1-1/4	1-1/2	2	2-1/2	3	4
Steel	6500	4500	4000	3500	2000	1750	1500	1500	1000	750	500
Aluminum	2250	2250	1750	1750	1500	375	375	300	300	200	150
Brass	2250	2250	2000	2000	1750	350	350	400	400	200	150
Stainless Steel	5000	4000	3750	2000	2000	1500	1500	500	400	400	300
Unvalved/Plain on both coupler and nipple (Straight Through)											
Steel	11000	11000	11000	9000	6000	5000	5000	4000	1000	750	500
Aluminum	4000	4000	4000	3500	3000	1000	1000	750	300	200	150
Brass	4000	4000	4000	3500	3000	1000	1000	750	300	200	150
Stainless Steel	10000	8000	8000	7000	4000	3000	3000	1000	400	400	300

NOTE: Pressure ratings were established under static pressure conditions. Therefore, pressure ratings for any given flow, pressure surge and/or vibration may vary from these ratings. Burst pressures listed were taken at the point at which failure rendered the quick disconnect inoperative. (Proof pressure equals 1-1/2 times the working pressure; burst pressure equals 2 times working pressure.)



Performance

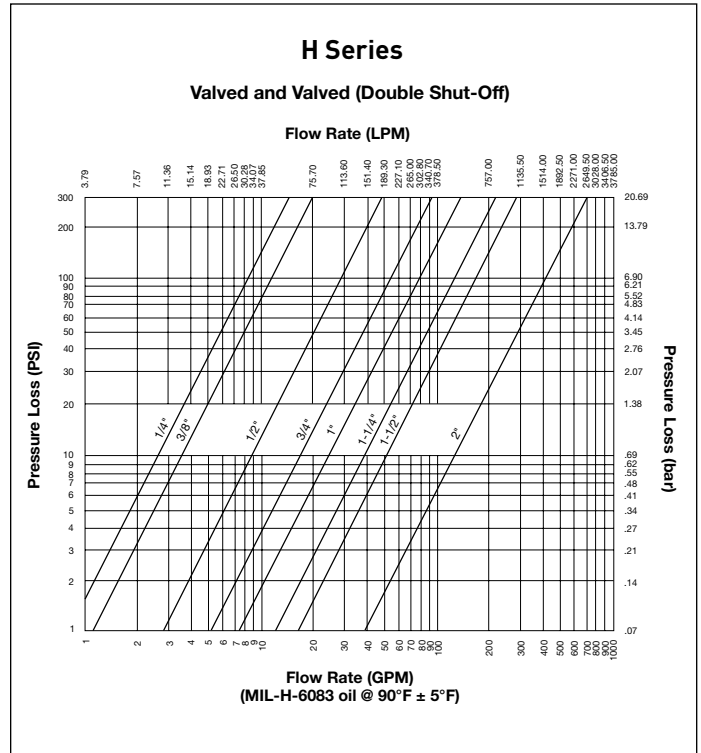
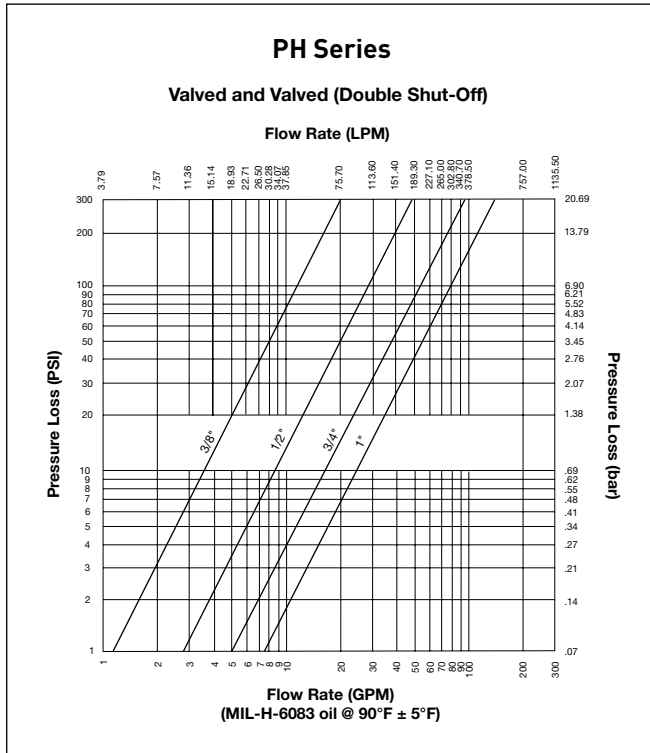

Repair Kits

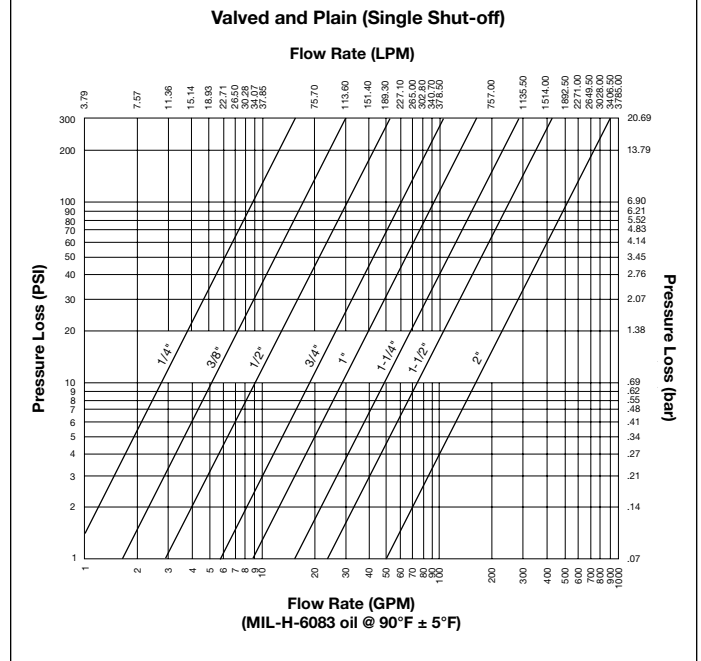
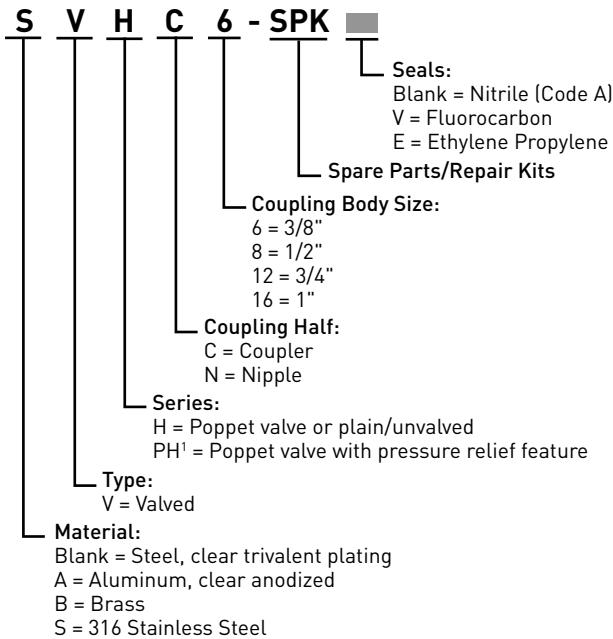

Repair kits include valve spring, valve stop and valve. O-ring installed on 3/8" to 1". 1/4" unit is non-field repairable.

Note: Not all configurations are standard product offering. Contact QCD for price and delivery.

Hydraulic Quick Couplings

General Purpose

H & PH Series

Snap-tite Design

Manual Sleeve, Valved or Unvalved



B Hydraulics

Valve Options		
	H Series Hydraulic Coupler/Nipple	PH Series Hydraulic Coupler/Nipple
Valve Styles:	<ul style="list-style-type: none"> • Poppet Valve • Unvalved/Plain 	<ul style="list-style-type: none"> • Connect-Under-Pressure Poppet Valve
Connection Types:	<ul style="list-style-type: none"> • Double Shut-off • Single Shut-off • Straight Through/Unvalved 	<ul style="list-style-type: none"> • Double Shut-off (connects with valved H Series Coupler or Nipple)
Body Sizes:	1/8" - 4"	3/8" - 1"
Materials:	<ul style="list-style-type: none"> • Steel • 316 Stainless Steel • Aluminum • Brass 	<ul style="list-style-type: none"> • Steel

Replacement Coupler Interface Seals		
Body Size	Nitrile	Fluorocarbon
1/4	H4-56-9	H4-56-9V
3/8	H6-56-9	H6-56-9V
1/2	H8-56-9	H8-56-9V
3/4	H12-56-9	H12-56-9V
1	H16-56-9	H16-56-9V
1-1/4	H20-56-9	H20-56-9V

Replacement Valve Seals			
Body Size	Nitrile	Fluorocarbon	Ethylene Propylene
1-1/4	H20-55A	H20-55V	H20-55E
1-1/2	H24-55A	H24-55V	H24-55E
2	H32-55A	H32-55V	H32-55E

Ordering Guide

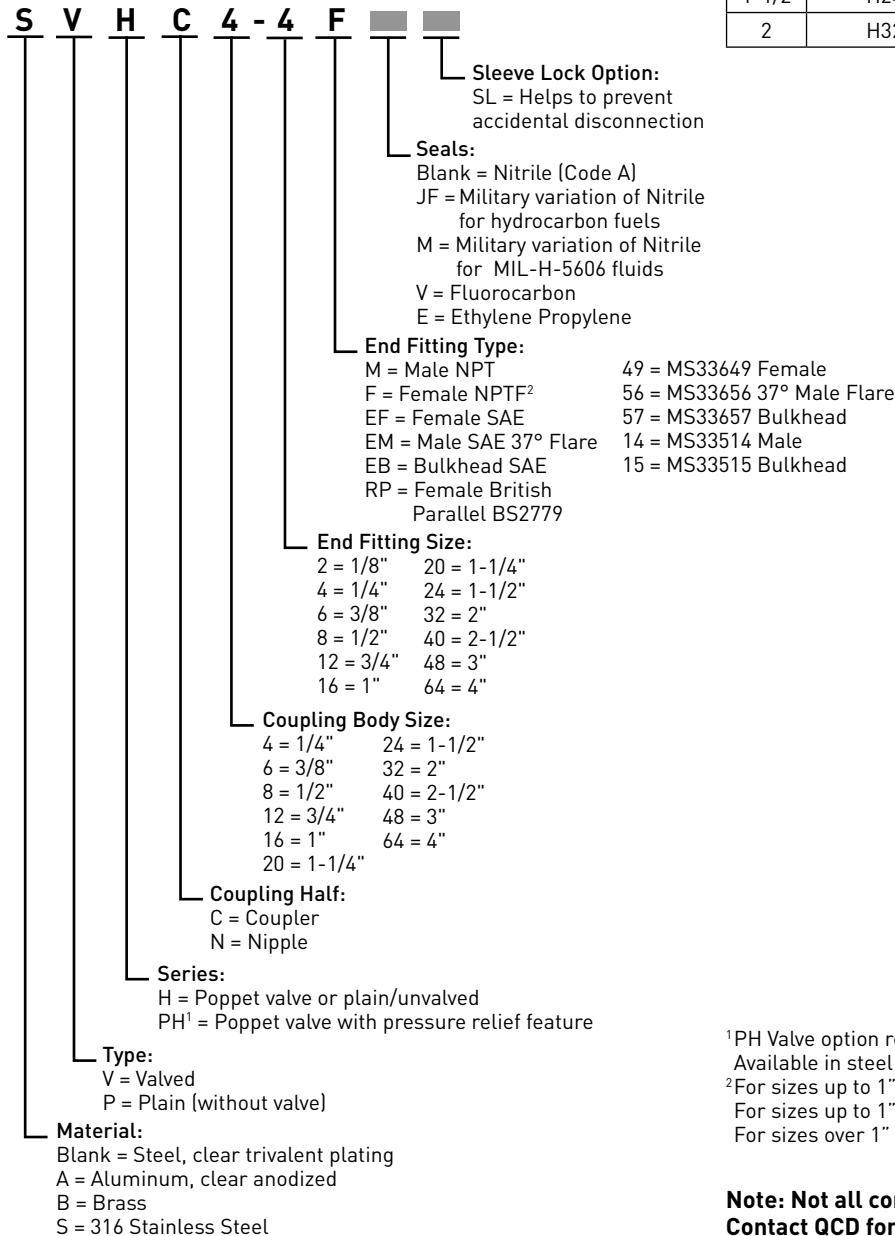

¹PH Valve option recommended on one side, not both. Available in steel only.

²For sizes up to 1" NPTF threads in steel. For sizes up to 1" NPSF threads in stainless steel. For sizes over 1" NPT threads.

Note: Not all configurations are standard product offering. Contact QCD for price and delivery.





H Series Couplers (Aluminum, Brass, Steel) - Female Thread



Body Size	Part Number Aluminum	Part Number Brass	Part Number Steel	Valved or Non-Valved (Plain)	Port End	Length (in)	Largest Diameter	Wrench Flats
1/4	-	-	VHC4-2F	Valved	1/8-27 NPTF	1.65	1.00	0.88
1/4	APHC4-4F	BPHC4-4F	PHC4-4F	Non-Valved	1/4-18 NPTF	1.34	1.02	0.88
1/4	AVHC4-4F	BVHC4-4F	VHC4-4F	Valved	1/4-18 NPTF	1.65	1.19	1.00
1/4	-	-	VHC4-4EF	Valved	7/16-20 UNF	1.80	1.02	0.88
3/8	APHC6-6F	BPHC6-6F	PHC6-6F	Non-Valved	3/8-18 NPTF	1.50	1.19	1.00
3/8	AVHC6-6F	BVHC6-6F	VHC6-6F	Valved	3/8-18 NPTF	1.90	1.19	1.00
3/8	-	-	VHC6-6EF	Valved	9/16-18 UNF	2.20	1.19	1.00
1/2	-	BPHC8-8F	PHC8-8F	Non-Valved	1/2-14 NPTF	1.62	1.39	1.19
1/2	AVHC8-8F	BVHC8-8F	VHC8-8F	Valved	1/2-14 NPTF	2.09	1.39	1.19
1/2	-	-	VHC8-8EF	Valved	3/4-16 UNF	2.19	1.39	1.19
3/4	-	BPHC12-12F	PHC12-12F	Non-Valved	3/4-14 NPTF	1.91	1.73	1.50
3/4	-	BVHC12-12F	VHC12-12F	Valved	3/4-14 NPTF	2.42	1.73	1.50
3/4	-	-	VHC12-12EFV	Valved	1-1/16 - 12 UNF	2.92	1.73	1.50
1	-	BPHC16-16F	PHC16-16F	Non-Valved	1 - 11-1/2 NPTF	2.07	2.17	1.88
1	-	BVHC16-16F	VHC16-16F	Valved	1 - 11-1/2 NPTF	2.67	2.17	1.88
1	-	-	VHC16-16EF	Valved	1-5/16 - 12 UNF	2.94	2.17	1.88
1-1/4	-	BPHC20-20F	PHC20-20F	Non-Valved	1-1/4 - 11-1/2 NPT	2.28	2.31	2.00
1-1/4	-	BVHC20-20F	VHC20-20F	Valved	1-1/4 - 11-1/2 NPT	3.54	2.31	2.00
1-1/2	-	BPHC24-24F	PHC24-24F	Non-Valved	1-1/2 - 11-1/2 NPT	2.57	2.89	2.50
1-1/2	-	BVHC24-24F	VHC24-24F	Valved	1-1/2 - 11-1/2 NPT	3.27	3.18	2.75
2	-	BPHC32-32F	PHC32-32F	Non-Valved	2 - 11-1/2 NPT	2.48	3.75	3.25
2	-	BVHC32-32F	VHC32-32F	Valved	2 - 11-1/2 NPT	3.92	4.33	3.75

B Hydraulics



WARNING: This product can expose you to chemicals including Lead, which is known to the State of California to cause cancer and birth defects or other reproductive harm. For more information go to www.P65Warnings.ca.gov





H Series Couplers (316 Stainless Steel) - Female Thread



Body Size	Part Number Stainless Steel**	Valved or Non-Valved (Plain)	Port End	Length (in)	Largest Diameter	Wrench Flats
1/4	SVHC4-2F	Valved	1/8-27 NPSF*	1.65	1.00	0.88
1/4	SPHC4-4F	Non-Valved	1/4-18 NPSF*	1.34	1.02	0.88
1/4	SVHC4-4F	Valved	1/4-18 NPSF*	1.65	1.19	1.00
3/8	SPHC6-6F	Non-Valved	3/8-18 NPSF*	1.50	1.19	1.00
3/8	SVHC6-6F	Valved	3/8-18 NPSF*	1.90	1.19	1.00
1/2	SPHC8-8F	Non-Valved	1/2-14 NPSF*	1.62	1.39	1.19
1/2	SVHC8-8F	Valved	1/2-14 NPSF*	2.09	1.39	2.09
3/4	SPHC12-12F	Non-Valved	3/4-14 NPSF*	1.91	1.73	1.50
3/4	SVHC12-12F	Valved	3/4-14 NPSF*	2.42	1.73	1.50
1	SPHC16-16F	Non-Valved	1 - 11-1/2 NPSF*	2.07	2.17	1.88
1	SVHC16-16F	Valved	1 - 11-1/2 NPSF*	2.67	2.17	1.88
1-1/4	SPHC20-20F	Non-Valved	1-1/4 - 11-1/2 NPT	2.28	2.31	2.00
1-1/4	SVHC20-20F	Valved	1-1/4 - 11-1/2 NPT	3.54	2.31	2.00
1-1/2	SPHC24-24F	Non-Valved	1-1/4 - 11-1/2 NPT	2.57	2.89	2.50
1-1/2	SVHC24-24F	Valved	1-1/2 - 11-1/2 NPT	3.27	3.18	2.75
2	SPHC32-32F	Non-Valved	2 - 11-1/2 NPT	2.48	3.75	3.25
2	SVHC32-32F	Valved	2 - 11-1/2 NPT	3.92	4.33	3.75

*NPSF thread may be substituted with equivalent NPT thread

** Prop 65 Warning does not apply to stainless steel part numbers

H Series Couplers (Aluminum, Brass, Steel) - Male Thread



Body Size	Part Number Aluminum	Part Number Brass	Part Number Steel	Valved or Non-Valved (Plain)	Port End	Length (in)	Largest Diameter	Wrench Flats
1/4	-	-	VHC4-2M	Valved	1/8-27 NPT	1.90	1.00	0.88
1/4	AVHC4-4M	BVHC4-4M	VHC4-4M	Valved	1/4-18 NPT	2.09	1.02	0.88
3/8	AVHC6-6M	-	VHC6-6M	Valved	3/8-18 NPT	2.19	1.19	1.00
3/8	-	BVHC6-6M	-	Valved	3/8-18 NPT	2.19	1.19	1.00
1/2	-	BVHC8-8M	-	Valved	1/2-14 NPT	2.57	1.39	1.19
1/2	-	-	VHC8-8M	Valved	1/2-14 NPT	2.46	1.39	1.19
3/4	-	BVHC12-12M	VHC12-12M	Valved	3/4-14 NPT	2.88	1.73	1.50
1	-	BVHC16-16M	VHC16-16M	Valved	1-11-1/2 NPT	3.21	2.17	1.88
2	-	-	VHC32-32M	Valved	2-11-1/2 NPT	4.54	4.33	3.75



WARNING: This product can expose you to chemicals including Lead, which is known to the State of California to cause cancer and birth defects or other reproductive harm. For more information go to www.P65Warnings.ca.gov



H Series Couplers (316 Stainless Steel) - Male Thread



Body Size	Part Number*	Valved or Non-Valved (Plain)	Port End	Length (in)	Largest Diameter	Wrench Flats
1/4	SVHC4-4M	Valved	1/4-18 NPT	2.09	1.02	0.88
3/8	SVHC6-6M	Valved	3/8-18 NPT	2.19	1.19	1.00
1/2	SVHC8-8M	Valved	1/2-14 NPT	2.57	1.39	1.19
3/4	SVHC12-12M	Valved	3/4-14 NPT	2.88	1.73	1.50
1	SVHC16-16M	Valved	1 - 11-1/2 NPT	3.21	2.17	1.88

* Prop 65 Warning does not apply to stainless steel part numbers

H Series Couplers (Steel) - Male SAE 37 Degree Flare



Body Size	Part Number	Valved or Non-Valved (Plain)	Port End	Length (in)	Largest Diameter	Wrench Flats
1/4	VHC4-4EM	Valved	7/16-20 UNF	2.80	1.02	0.88
3/8	VHC6-6EM	Valved	9/16-18 UNF	2.24	1.19	1.00
1/2	VHC8-8EM	Valved	3/4-16 UNF	2.46	1.39	1.19
3/4	VHC12-12EM	Valved	1-1/6 - 12 UNF	3.05	1.73	1.50

PH Series Connect-Under-Pressure Couplers (Steel) - Female Thread



Body Size	Part Number	Valved or Non-Valved (Plain)	Port End	Length (in)	Largest Diameter	Wrench Flats
3/8	VPHC6-6F	Valved	3/8-18 NPTF	1.90	1.19	1.00
1/2	VPHC8-8F	Valved	1/2-14 NPTF	2.09	1.39	1.19
3/4	VPHC12-12EF	Valved	1-1/16 - 12 UNF	2.92	1.73	1.50
3/4	VPHC12-12F	Valved	3/4-14 NPTF	2.42	1.73	1.50



WARNING: This product can expose you to chemicals including Lead, which is known to the State of California to cause cancer and birth defects or other reproductive harm. For more information go to www.P65Warnings.ca.gov



H Series Nipples (Aluminum, Brass, Steel) - Female Thread



Body Size	Part Number Aluminum	Part Number Brass	Part Number Steel	Valved or Non-Valved (Plain)	Port End	Length (in)	Largest Diameter	Wrench Flats
1/4	-	BPHN4-2F	PHN4-2F	Non-Valved	1/8-27 NPTF	1.11	0.62	0.56
1/4	-	-	VHN4-2F	Valved	1/8-27 NPTF	1.59	1.00	0.88
1/4	APHN4-4F	BPHN4-4F	-	Non-Valved	1/4-18 NPTF	1.32	0.73	0.88
1/4	AVHN4-4F	BVHN4-4F	-	Valved	1/4-18 NPTF	1.59	1.02	0.88
1/4	-	-	PHN4-4F	Non-Valved	1/4-18 NPTF	1.32	0.73	0.63
1/4	-	-	VHN4-4F	Valved	1/4-18 NPTF	1.65	1.19	1.00
3/8	APHN6-6F	BPHN6-6F	-	Non-Valved	3/8-18 NPTF	1.52	0.94	1.00
3/8	-	-	PHN6-6F	Non-Valved	3/8-18 NPTF	1.52	0.94	0.81
3/8	AVHN6-6F	BVHN6-6F	VHN6-6F	Valved	3/8-18 NPTF	1.84	1.19	1.00
1/2	AVHN8-8F	-	-	Valved	1/2-14 NPTF	1.98	1.19	1.00
1/2	-	BPHN8-8F	PHN8-8F	Non-Valved	1/2-14 NPTF	1.72	1.15	1.00
1/2	-	BVHN8-8F	VHN8-8F	Valved	1/2-14 NPTF	1.98	1.39	1.19
1/2	-	-	VHN8-8EF	Valved	3/4-16 UNF	2.08	1.39	1.19
3/4	-	BPHN12-12F	PHN12-12F	Non-Valved	3/4-14 NPTF	1.92	1.37	1.19
3/4	-	BVHN12-12F	VHN12-12F	Valved	3/4-14 NPTF	2.29	1.73	1.50
3/4	-	-	VHN12-12EF	Valved	1-1/16 - 12 UNF	2.79	1.73	1.50
1	-	BPHN16-16F	PHN16-16F	Non-Valved	1 - 11-1/2 NPTF	2.10	1.73	1.50
1	-	BVHN16-16F	VHN16-16F	Valved	1 - 11-1/2 NPTF	2.55	2.17	1.88
1	-	-	VHN16-16EF	Valved	1-5/16 - 12 UNF	2.82	2.17	1.88
1-1/4	-	BPHN20-20F	PHN20-20F	Non-Valved	1-1/4 - 11-1/2 NPTF	2.22	2.17	1.88
1-1/4	-	BVHN20-20F	VHN20-20F	Valved	1-1/4 - 11-1/2 NPTF	3.41	2.31	2.00
1-1/2	-	BPHN24-24F	PHN24-24F	Non-Valved	1-1/2 - 11-1/2 NPTF	2.44	2.46	2.13
1-1/2	-	BVHN24-24F	VHN24-24F	Valved	1-1/2 - 11-1/2 NPTF	3.11	3.18	2.75
2	-	BPHN32-32F	PHN32-32F	Non-Valved	2 - 11-1/2 NPTF	2.60	3.18	2.75
2	-	BVHN32-32F	VHN32-32F	Valved	2 - 11-1/2 NPTF	3.72	4.33	3.75

B Hydraulics



WARNING: This product can expose you to chemicals including Lead, which is known to the State of California to cause cancer and birth defects or other reproductive harm. For more information go to www.P65Warnings.ca.gov





H Series Nipples (316 Stainless Steel) - Female Thread



Body Size	Part Number	Valved or Non-Valved (Plain)	Port End	Length (in)	Largest Diameter	Wrench Flats
1/4	SPHN4-2F	Non-Valved	1/8-27 NPSF*	1.11	0.62	0.56
1/4	SVHN4-2F	Valved	1/8-27 NPSF*	1.59	1.00	0.56
1/4	SPHN4-4F	Non-Valved	1/4-18 NPSF*	1.32	0.73	0.63
1/4	SVHN4-4F	Valved	1/4-18 NPSF*	1.59	1.02	0.88
3/8	SPHN6-6F	Non-Valved	3/8-18 NPSF*	1.52	0.94	0.81
3/8	SVHN6-6F	Valved	3/8-18 NPSF*	1.84	1.19	1.00
1/2	SPHN8-8F	Non-Valved	1/2-14 NPSF*	1.72	1.15	2.00
1/2	SVHN8-8F	Valved	1/2-14 NPSF*	1.98	1.39	1.19
3/4	SPHN12-12F	Non-Valved	3/4-14 NPSF*	1.92	1.37	1.19
3/4	SVHN12-12F	Valved	3/4-14 NPSF*	2.29	1.73	1.50
1	SPHN16-16F	Non-Valved	1 - 11-1/2 NPSF*	2.10	1.73	1.50
1	SVHN16-16F	Valved	1 - 11-1/2 NPSF*	2.55	2.17	1.88
1-1/4	SPHN20-20F	Non-Valved	1-1/4 - 11-1/2 NPTF	2.22	2.17	1.88
1-1/4	SVHN20-20F	Valved	1-1/4 - 11-1/2 NPTF	3.41	2.31	1.88
1-1/2	SPHN24-24F	Non-Valved	1-1/2 - 11-1/2 NPTF	2.44	2.46	2.13
1-1/2	SVHN24-24F	Valved	1-1/2 - 11-1/2 NPTF	3.11	3.18	3.75
2	SPHN32-32F	Non-Valved	2 - 11-1/2 NPTF	2.60	3.18	2.75
2	SVHN32-32F	Valved	2 - 11-1/2 NPTF	3.72	4.33	3.75

*NPSF thread may be substituted with equivalent NPT thread



H Series Nipples (Aluminum, Brass, Steel) - Male Thread



Body Size	Part Number Aluminum	Part Number Brass	Part Number Steel	Valved or Non-Valved (Plain)	Port End	Length (in)	Largest Diameter	Wrench Flats
1/4	-	BPHN4-2M	-	Non-Valved	1/8-27 NPT	1.22	0.64	0.56
1/4	-	-	PHN4-2M	Non-Valved	1/8-27 NPT	1.11	0.62	0.56
1/4	-	-	VHN4-2M	Valved	1/8-27 NPT	1.85	1.00	0.88
1/4	APHN4-4M	BPHN4-4M	PHN4-4M	Non-Valved	1/4-18 NPT	0.78	0.65	0.56
1/4	AVHN4-4M	BVHN4-4M	VHN4-4M	Valved	1/4-18 NPT	2.03	1.02	0.88
3/8	-	BPHN6-6M	PHN6-6M	Non-Valved	3/8-18 NPT	0.98	0.80	0.69
3/8	AVHN6-6M	BVHN6-6M	VHN6-6M	Valved	3/8-18 NPT	2.13	1.19	1.00
1/2	-	BPHN8-8M	PHN8-8M	Non-Valved	1/2-14 NPT	1.01	1.02	0.88
1/2	-	BVHN8-8M	VHN8-8M	Valved	1/2-14 NPT	2.46	1.39	1.19
3/4	-	BPHN12-12M	PHN12-12M	Non-Valved	3/4-14 NPT	1.14	1.22	1.06
3/4	-	BVHN12-12M	VHN12-12M	Valved	3/4-14 NPT	2.75	1.73	1.50
1	-	BPHN16-16M	-	Non-Valved	1 - 11-1/2 NPT	1.16	1.59	1.38
1	-	-	PHN16-16M	Non-Valved	1-11-1/2 NPT	1.16	1.73	1.88
1	-	BVHN16-16M	VHN16-16M	Valved	1 - 11-1/2 NPT	3.09	2.17	1.88
1-1/4	-	-	VHN20-20M	Valved	1-1/4 - 11-1/2 NPT	3.46	2.31	2.00
2	-	-	PHN32-32M	Non-Valved	2 - 11-1/2 NPT	2.03	2.89	2.50

H Series Nipples (316 Stainless Steel) - Male Thread



Body Size	Part Number*	Valved or Non-Valved (Plain)	Port End	Length (in)	Largest Diameter	Wrench Flats
1/4	SPHN4-2M	Non-Valved	1/8-27 NPT	1.22	0.64	0.56
1/4	SPHN4-4M	Non-Valved	1/4-18 NPT	0.78	0.65	0.56
1/4	SVHN4-4M	Valved	1/4-18 NPT	2.03	1.02	0.88
3/8	SPHN6-6M	Non-Valved	3/8-18 NPT	0.98	0.80	0.69
3/8	SVHN6-6M	Valved	3/8-18 NPT	2.13	1.19	1.00
1/2	SPHN8-8M	Non-Valved	1/2-14 NPT	1.01	1.02	0.88
1/2	SVHN8-8M	Valved	1/2-14 NPT	2.46	1.39	1.19
3/4	SVHN12-12M	Valved	3/4-14 NPT	2.75	1.73	1.50
1	SVHN16-16M	Valved	1 - 11-1/2 NPT	3.09	2.17	1.80
1-1/4	SVHN20-20M	Valved	1-1/4 - 11-1/2 NPT	3.46	2.31	2.00

* Prop 65 Warning does not apply to stainless steel part numbers



WARNING: This product can expose you to chemicals including Lead, which is known to the State of California to cause cancer and birth defects or other reproductive harm. For more information go to www.P65Warnings.ca.gov



H Series Nipples (Steel) - Male SAE 37 Degree Flare



Body Size	Part Number	Valved or Non-Valved (Plain)	Port End	Length (in)	Largest Diameter	Wrench Flats
1/4	VHN4-4EM	Valved	7/16-20 UNF	2.02	1.02	0.88
3/8	VHN6-6EM	Valved	9/16-18 UNF	2.24	1.19	1.00
1/2	VHN8-8EM	Valved	3/4-16 UNF	2.35	1.39	1.19
3/4	VHN12-12EM	Valved	1-1/6 - 12 UNF	2.92	1.73	1.50

PH Series Connect-Under-Pressure Nipples (Steel)



Body Size	Part Number	Valved or Non-Valved (Plain)	Port End	Length (in)	Largest Diameter	Wrench Flats
1/2	VPHN8-8F	Valved	1/2-14 NPTF (Female)	1.98	1.39	1.19
1/2	VPHN8-8EM	Valved	3/4-16 UNF (Male)	2.35	1.39	1.19

H Series Dust Plugs and Caps



Body Size	Coupler Dust Plug Plastic	Coupler Dust Plug Aluminum	Nipple Dust Cap Plastic	Nipple Dust Cap Aluminum	Nipple Pressure Cap
1/4	PDP-4	AMPH-4	PDC-4	ADCH-4	MCH-4
3/8	PDP-6	AMPH-6	PDC-6	ADCH-6	MCH-6
1/2	PDP-8	AMPH-8	PDC-8	ADCH-8	MCH-8
3/4	PDP-12	AMPH-12	PDC-12	ADCH-12	MCH-12
1	PDP-16	AMPH-16	PDC-16	ADCH-16	MCH-16
1-1/4	-	AMPH-20	-	ADCH-20	MCH-20
1-1/2	-	AMPH-24	-	ADCH-24	MCH-24
2	-	AMPH-32	-	ADCH-32	MCH-32
2-1/2	-	AMPH-40	-	ADCH-40	MCH-40
3	-	AMPH-48	-	ADCH-48	MCH-48

WARNING: This product can expose you to chemicals including Lead and DEHP, which is known to the State of California to cause cancer and birth defects or other reproductive harm. For more information go to www.P65Warnings.ca.gov

Hydraulic Quick Couplings General Purpose

EA Series Vacuum Couplings

Vacuum to Medium Pressure



B Hydraulics



EA Series couplings are designed specifically for vacuum and medium pressure service, providing a dependable means for speeding fluid line changeover in autoclave applications. Single and double shut off combinations.

Features:

- Vacuum capability
- Available in a variety of materials
- Wide range of sizes
- Nitrile is standard seal material, other options available

Applications include:

- Aircraft fabrication
- Plastic molding
- Horizontal boring and dewatering

EA Series Specifications				
Body Size	Force to Connect (Double Shut Off)		Spillage on Disconnect (Double Shut Off)	
	Internal Pressure (psi)	Force to Connect (lbs)	With 10 psi Internal Pressure (cc or ml)	With 50 psi Pressure (cc or ml)
1/4	200	50	1.2	1.5
3/8	200	60	1.4	2.5
1/2	200	95	4.2	4.6
3/4	100	95	10.5	11.6

EA Series Pressure Ratings						
Body Size	Steel		316 Stainless Steel		Brass	
	Maximum Working (psi)	Minimum Burst (psi)	Maximum Working (psi)	Minimum Burst (psi)	Maximum Working (psi)	Minimum Burst (psi)
1/4	3000	6000	3000	6000	1500	3000
3/8	3000	6000	3000	6000	1500	3000
1/2	3000	6000	3000	6000	1500	3000
3/4	2000	4000	2000	4000	1500	3000

Pressure ratings were established under static pressure conditions. Therefore, pressure ratings for any given flow, pressure surge and/or vibration may vary from those ratings.

Vacuum Capability at Standard Barometric Conditions								
	1/4		3/8		1/2		3/4	
	in.hg	atm	in.hg	atm	in.hg	atm	in.hg	atm
Connected	29.7	.99	29.7	.99	29.7	.99	29.7	.99
Coupler or Nipple Alone (disconnected)	29.7	.99	29.7	.99	29.7	.99	29.7	.99



Performance

EA Series Valved & Valved (Double Shut-off)

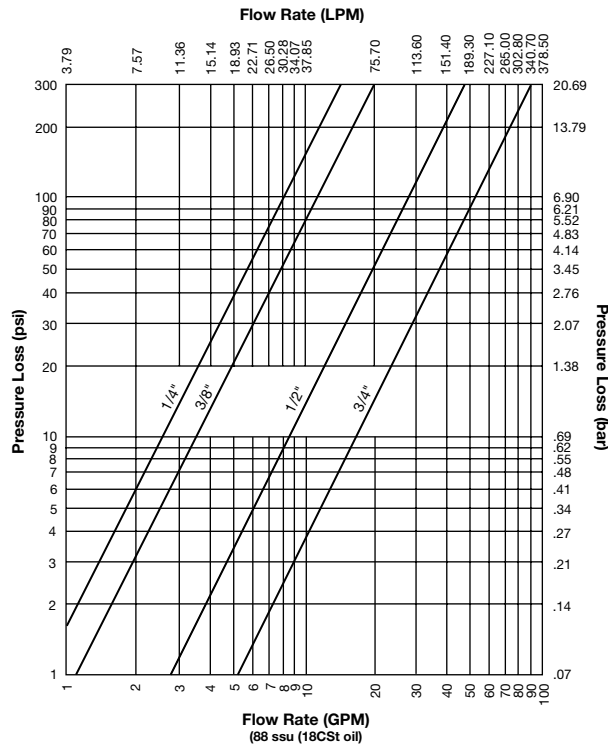

EA Series Valved & Plain (Single Shut-off)

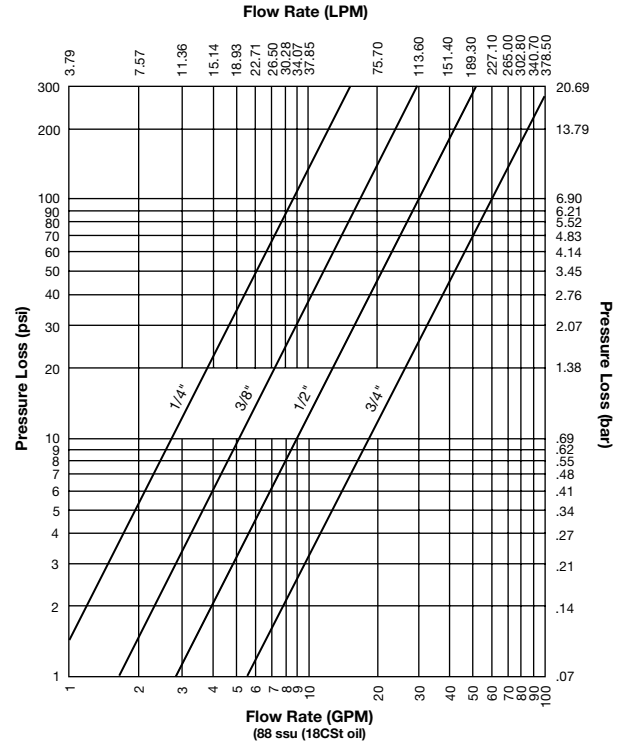

EA Series Repair Kits and Replacement Parts			
Body Size	Part Number	Description	Seal Material
1/2	VEAC8-SPK	Coupler Valve Repair Kit	Nitrile
1/2	VEAN8-SPK	Nipple Valve Repair Kit	Nitrile
1/4	EA4-58AS	Coupler Interface Seal	Aflas
1/2	EA8-58V	Coupler Interface Seal	Fluorocarbon
3/4	EA12-58A	Coupler Interface Seal	Nitrile

Repair Kits

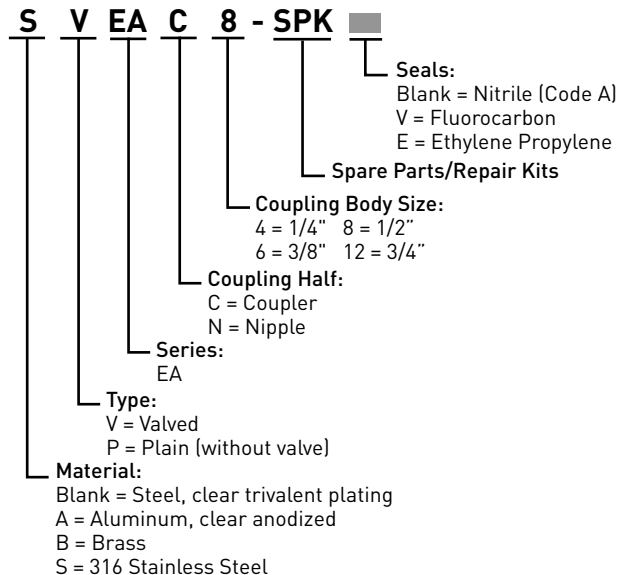

Optional Seal Materials for Couplers and Valved Nipples

(add code to part number)

Code	Description	Part Number Example
suffix V	Fluorocarbon seal material	VEAN4-4FV
suffix E	Ethylene Propylene seal material (EPR)	VEAC6-6ME
suffix AS	Aflas seal material	VEAC6-6FAS

Contact QCD for availability and additional options.
To select proper seal materials, see Fluid Compatibility Chart or contact QCD.



EA Series Couplers (Brass, Steel, 316 Stainless Steel) - Female Thread



Body Size	Part Number Brass	Part Number Steel	Port End	Part Number 316 Stainless Steel**	Port End*	Valved or Non-Valved (Plain)	Length (in)	Largest Diameter	Wrench Flats
1/4	BPEAC4-4F	PEAC4-4F	1/4-18 NPTF	SPEAC4-4F	1/4-18 NPSF	Non-Valved	1.33	1.13	0.88
1/4	BVEAC4-4F	VEAC4-4F	1/4-18 NPTF	SVEAC4-4F	1/4-18 NPSF	Valved	1.61	1.13	0.88
3/8	BPEAC6-6F	PEAC6-6F	3/8-18 NPTF	-	-	Non-Valved	1.58	1.31	1.00
3/8	BVEAC6-6F	VEAC6-6F	3/8-18 NPTF	-	-	Valved	1.86	1.31	1.00
1/2	BPEAC8-8F	PEAC8-8F	1/2-14 NPTF	-	-	Non-Valved	1.70	1.44	1.19
1/2	BVEAC8-8F	VEAC8-8F	1/2-14 NPTF	SVEAC8-8F	1/2-14 NPSF	Valved	2.09	1.44	1.19
3/4	BPEAC12-12F	-	3/4-14 NPTF	SPEAC12-12F	3/4-14 NPSF	Non-Valved	2.41	1.88	1.50
3/4	BVEAC12-12F	VEAC12-12F	3/4-14 NPTF	SVEAC12-12F	3/4-14 NPSF	Valved	2.91	1.88	1.50

EA Series Couplers (Brass, Steel, 316 Stainless Steel) - Male Thread



Body Size	Part Number Brass	Part Number Steel	Port End	Part Number 316 Stainless Steel**	Port End*	Valved or Non-Valved (Plain)	Length (in)	Largest Diameter	Wrench Flats
1/4	-	PEAC4-4M	1/4-18 NPTF	SPEAC4-4M	1/4-18 NPSF	Non-Valved	1.48	1.13	0.88
1/4	-	VEAC4-4M	1/4-18 NPTF	-	1/4-18 NPSF	Valved	2.05	1.13	0.88
3/8	BVEAC6-6M	VEAC6-6M	3/8-18 NPTF	-	-	Valved	2.15	1.31	1.00
1/2	BVEAC8-8M	VEAC8-8M	1/2-14 NPTF	SVEAC8-8M	1/2-14 NPSF	Valved	2.46	1.44	1.19
3/4	BVEAC12-12M	VEAC12-12M	3/4-14 NPTF	-	-	Valved	2.87	1.88	1.50

*May be substituted with NPT threads

Contact QCD for additional sizes, materials and end configurations.

** Prop 65 Warning does not apply to stainless steel part numbers



WARNING: This product can expose you to chemicals including Lead, which is known to the State of California to cause cancer and birth defects or other reproductive harm. For more information go to www.P65Warnings.ca.gov



EA Series Nipples (Brass, Steel, 316 Stainless Steel) - Female Thread



Body Size	Part Number Brass	Part Number Steel	Port End	Part Number 316 Stainless Steel**	Port End*	Valved or Non-Valved (Plain)	Length (in)	Largest Diameter	Wrench Flats
1/4	-	-	-	SVEAN4-2F	1/8-27 NPSF	Valved	1.61	1.00	0.88
1/4	BPEAN4-4F	PEAN4-4F	1/4-18 NPTF	SPEAN4-4F	1/4-18 NPSF	Non-Valved	1.33	0.73	0.62
1/4	-	VEAN4-4F	1/4-18 NPTF	SVEAN4-4F	1/4-18 NPSF	Valved	1.61	1.00	0.88
3/8	BPEAN6-6F	PEAN6-6F	3/8-18 NPTF	-	-	Non-Valved	1.58	0.94	0.81
3/8	BVEAN6-6F	VEAN6-6F	3/8-18 NPTF	-	-	Valved	1.86	1.15	1.00
1/2	BPEAN8-8F	PEAN8-8F	1/2-14 NPTF	-	-	Non-Valved	1.70	1.15	1.00
1/2	BVEAN8-8F	VEAN8-8F	1/2-14 NPTF	SVEAN8-8F	1/2-14 NPSF	Valved	2.09	1.31	1.19
3/4	BPEAN12-12F	-	3/4-14 NPTF	SPEAN12-12F	3/4-14 NPSF	Non-Valved	2.05	1.37	1.19
3/4	BVEAN12-12F	VEAN12-12F	3/4-14 NPTF	SVEAN12-12F	3/4-14 NPSF	Valved	2.29	1.73	1.50

EA Series Nipples (Brass, Steel, 316 Stainless Steel) - Male Thread



Body Size	Part Number Brass	Part Number Steel	Port End	Part Number 316 Stainless Steel**	Port End*	Valved or Non-Valved (Plain)	Length (in)	Largest Diameter	Wrench Flats
1/4	-	PEAN4-4M	1/4-18 NPTF	SPEAN4-4M	1/4-18 NPSF	Non-Valved	1.43	0.65	0.56
1/4	-	VEAN4-4M	1/4-18 NPTF	SVEAN4-4M	1/4-18 NPSF	Valved	2.21	1.02	0.88
3/8	BVEAN6-6M	VEAN6-6M	3/8-18 NPTF	-	-	Valved	2.15	1.15	1.00
1/2	BVEAN8-8M	VEAN8-8M	1/2-14 NPTF	SVEAN8-8M	1/2-14 NPSF	Valved	2.46	1.31	1.19
3/4	BVEAN12-12M	VEAN12-12M	3/4-14 NPTF	-	-	Valved	2.75	1.65	1.50

*May be substituted with NPT threads
 Contact QCD for additional sizes, materials and end configurations.
 ** Prop 65 Warning does not apply to stainless steel part numbers

EA Series Dust Plugs and Caps



Body Size	Coupler Dust Plug Plastic	Coupler Dust Plug Aluminum	Nipple Dust Cap Plastic	Nipple Dust Cap Aluminum	Nipple Pressure Cap
1/4	PDP-4	AMPE-4	PDC-4	ADCE-4	MCE-4
3/8	PDP-6	AMPE-6	PDC-6	ADCE-6	MCE-6
1/2	PDP-8	AMPE-8	PDC-8	ADCE-8	MCE-8
3/4	PDP-12	AMPE-12	PDC-12	ADCE-12	MCE-12

WARNING: This product can expose you to chemicals including Lead and DEHP, which is known to the State of California to cause cancer and birth defects or other reproductive harm. For more information go to www.P65Warnings.ca.gov





SM Series double shut-off couplings are versatile for use across a spectrum of hydraulic applications where fluid lines require connection and disconnection. Couplers and nipples are steel with nitrile seals and are available in 1/4 through 3/4 inch sizes.

Features:

- Rated pressures up to 6000 psi
- Poppet valves have captive seals to minimize seal washout
- Steel material with standard nitrile seals
- Standard end configurations include female pipe, straight thread ORB, and British pipe
- Alternative seal materials available

Applications:

- Industrial hydraulic lines
- Mobile equipment

Specifications			
Body Size	1/4	1/2	3/4
Rated Pressure (PSI)	6,000	6,000	4,500
Rated Flow (GPM)	3	12	28
Temperature Range (Nitrile Seals)	-40° to +250°F		

Performance

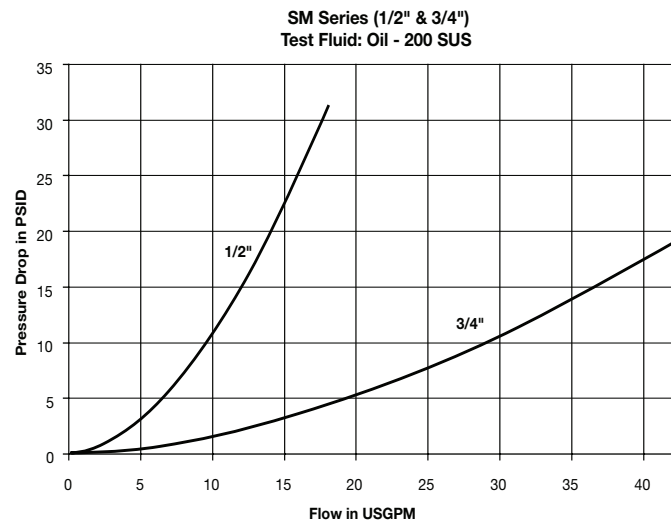
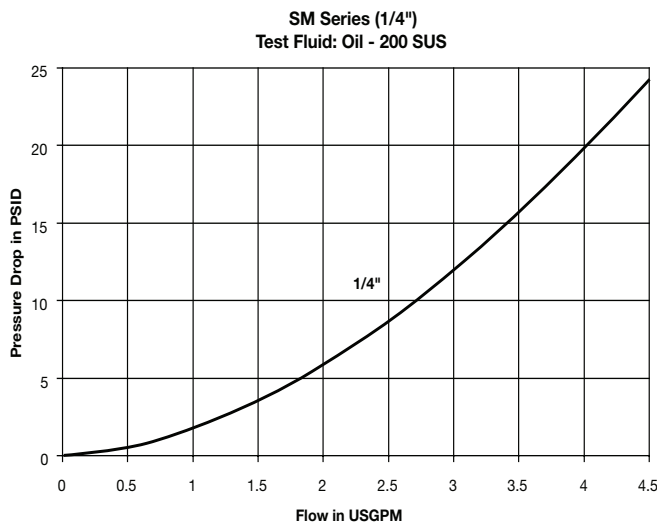

Optional Materials and Features:

(add code to part number)

Code	Description	Part Number Example
suffix -SL	Sleeve-Lok (Couplers)	SM-501-8FP-SL
suffix -E5	Ethylene Propylene seal material (EPR)	SM-501-8FP-E5
suffix -E4	Fluorocarbon seal material	SM-501-8FP-E4
suffix -E12	Neoprene seal material	SM-501-8FP-E12

Contact QCD for availability and additional options.
To select proper seal materials, see Fluid Compatibility Chart or contact QCD.



Couplers - Female Thread



Body Size	Part Number Steel	Thread Size	Length	Largest Diameter	Wrench Flats	Weight (lbs.)
1/4	SM-251-4FP	1/4-18 NPTF	2.09	1.06	0.75	0.24
1/4	SM-251-4FB	G1/4 BSPP	2.24	1.06	0.75	0.26
1/4	SM-251-6FP	3/8-18 NPTF	2.24	1.06	0.94	0.28
1/4	SM-251-6FB	G3/8 BSPP	2.24	1.06	0.94	0.26
1/4	SM-251-6FO	9/16-18 ORB	2.24	1.06	0.75	0.25
1/2	SM-501-8FP	1/2-14 NPTF	3.00	1.56	1.25	0.70
1/2	SM-501-8FB	G1/2 BSPP	3.00	1.56	1.25	0.74
1/2	SM-501-8FO	3/4-16 ORB	3.16	1.56	1.25	0.70
1/2	SM-501-12FP	3/4-14 NPTF	3.07	1.56	1.37	0.81
1/2	SM-501-12FB	G3/4 BSPP	3.16	1.56	1.37	0.85
3/4	SM-751-12FO	1 1/16-12 ORB	3.89	2.22	1.62	1.78
3/4	SM-751-12FP	3/4-14 NPTF	3.77	2.22	1.62	1.83
3/4	SM-751-12FB	G3/4 BSPP	3.89	2.22	1.62	1.88
3/4	SM-751-16FP	1-11 1/2 NPTF	3.98	2.22	1.62	1.84
3/4	SM-751-16FB	G 1 BSPP	3.98	2.22	1.62	1.89
3/4	SM-751-16FO	1-5/16 - 12 ORB	3.98	2.22	1.62	1.89

Nipple - Female Thread



Body Size	Part Number Steel	Thread Size	Length	Exposed* Length	Largest Diameter	Wrench Flats	Weight (lbs.)
1/4	SM-252-4FP	1/4-18 NPTF	1.49	0.50	0.87	0.75	0.08
1/4	SM-252-4FB	G1/4 BSPP	1.64	0.65	0.87	0.75	0.09
1/4	SM-252-6FP	3/8-18 NPTF	1.64	0.81	1.08	0.94	0.14
1/4	SM-252-6FB	G3/8 BSPP	1.64	0.81	1.08	0.94	0.14
1/4	SM-252-6FO	9/16-18 ORB	1.64	0.55	0.87	0.75	0.08
1/2	SM-502-8FO	3/4-16 ORB	2.14	0.72	1.23	1.06	0.16
1/2	SM-502-8FP	1/2-14 NPTF	2.01	0.45	1.23	1.06	0.15
1/2	SM-502-8FB	G1/2 BSPP	2.01	0.60	1.23	1.06	0.18
1/2	SM-502-12FP	3/4-14 NPTF	2.31	0.90	1.59	1.37	0.30
1/2	SM-502-12FB	G3/4 BSPP	2.63	1.07	1.59	1.37	0.34
3/4	SM-752-12FO	1 1/16-12 ORB	2.60	0.39	1.73	1.50	0.48
3/4	SM-752-12FP	3/4-14 NPTF	2.48	0.39	1.73	1.50	0.52
3/4	SM-752-12FB	G3/4 BSPP	2.60	0.53	1.73	1.50	0.56
3/4	SM-752-16FP	1-11 1/2 NPTF	2.69	0.67	1.88	1.62	0.56
3/4	SM-752-16FB	G 1 BSPP	2.69	0.67	1.88	1.62	0.68
3/4	SM-752-16FO	1-5/16 - 12 ORB	2.69	0.67	1.88	1.62	0.68

* This dimension represents the portion that is exposed when the nipple is inserted into the mating Parker Coupler.



WARNING: This product can expose you to chemicals including Lead, which is known to the State of California to cause cancer and birth defects or other reproductive harm. For more information go to www.P65Warnings.ca.gov



SM Series Dust Caps and Plugs



Body Size	Nipple Dust Cap	Color/Material	Coupler Dust Plug
1/4	N/A	Plastic	PL-25
1/4	CR-25	Black Rubber	PR-25
1/4	C-25	Aluminum	P-25
1/2	DC-50	Black Rubber	DP-50
1/2	C-50	Aluminum	P-50
3/4	C-75	Aluminum	P-75

 **WARNING:** This product can expose you to chemicals including DEHP, which is known to the State of California to cause cancer and birth defects or other reproductive harm. For more information go to www.P65Warnings.ca.gov

B Hydraulics



HP Series double shut-off couplings are designed for pressures up to 5000 psi. Couplers and nipples are steel with nitrile seals and are available in 1 and 1-1/2 inch sizes.

Features:

- Rated pressures up to 5000 psi
- Smooth flow path with minimal pressure drop
- Heat treated steel nipple and heavy duty sleeve withstand pressure surges
- Couplings have protective zinc with clear trivalent chromate finish
- Standard end configurations include female pipe and straight thread ORB
- Alternative seal materials available

Applications:

- Industrial hydraulic lines
- Mobile equipment

Performance

HP Series (1" & 1-1/2")
Test Fluid: Oil - 200 SUS

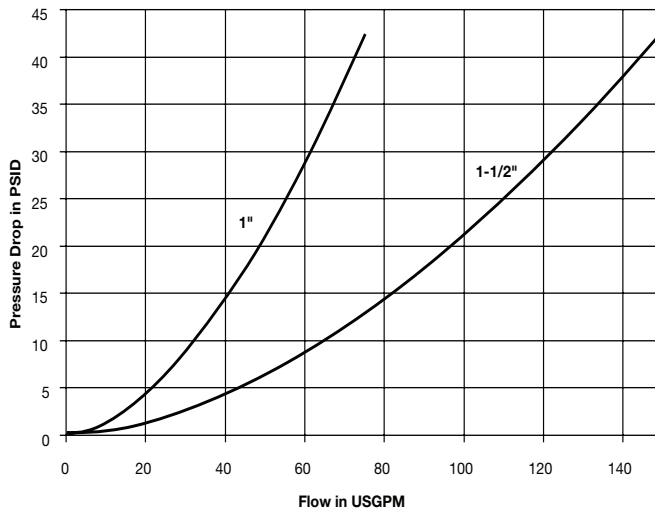

Specifications

Body Size	1	1 - 1/2
Rated Pressure (PSI)	5,000	
Rated Flow (GPM)	50	100
Temperature Range (std seals)	-40° to +250°F	

Optional Seal Materials:

(add code to part number)

Code	Description	Part Number Example
suffix -E5	Ethylene Propylene seal material (EPR)	HP-1001-16FP-E5
suffix -E4	Fluorocarbon seal material	HP-1001-16FP-E4
suffix -E12	Neoprene seal material	HP-1001-16FP-E12

Contact QCD for availability and additional options.

To select proper seal materials, see Fluid Compatibility Chart or contact QCD.



Couplers



Body Size	Part Number	Thread Size	Length	Largest Diameter	Wrench Flats	Weight (lbs.)
1	HP-1001-16FP	1 11-1/2 NPSF	3.95	2.38	1.62	2.10
1	HP-1001-16FO	1 5/16-12 ORB	4.35	2.38	1.62	2.10
1-1/2	HP-1501-24FP	1 1/2-11 1/2 NPTF	4.93	3.00	2.25	4.40
1-1/2	HP-1501-24FO	1 7/8 -12 ORB	4.93	3.00	2.25	4.40

Nipples



Body Size	Part Number	Thread Size	Overall Length	Exposed* Length	Largest Diameter	Wrench Flats	Weight (lbs.)
1	HP-1002-16FP	1 11-1/2 NPSF	3.00	1.32	1.88	1.62	0.84
1	HP-1002-16FO	1 5/16-12 ORB	3.40	1.72	1.88	1.62	0.84
1-1/2	HP-1502-24FP	1 1/2-11 1/2 NPTF	4.06	0.99	2.63	2.25	1.85
1-1/2	HP-1502-24FO	1 7/8-12 ORB	4.06	0.99	2.63	2.25	1.85

* This dimension represents the portion that is exposed when the nipple is inserted into the mating Parker Coupler.

Dust Plugs and Caps



Protective Plugs for Coupler			Protective Caps for Nipple		
Part Number	Material*	Fits Coupler	Part Number	Material*	Fits Nipple
HPP-100	Aluminum	HP-1001	HPC-100	Aluminum	HP-1002
HPP-150	Aluminum	HP-1501	HPC-150	Aluminum	HP-1502

* Prop 65 Warning does not apply to aluminum.



WARNING: This product can expose you to chemicals including Lead, which is known to the State of California to cause cancer and birth defects or other reproductive harm. For more information go to www.P65Warnings.ca.gov



The 4000 Series brings to the industry a proven design for use on agricultural machinery and other rugged applications.

Features:

- 1/2" size accepts ISO 5675 universal tips
- Basic operation where coupler sleeve is manually retracted to allow connection with male tip
- Critical parts are hardened
- Ball and poppet valve options
- Protective zinc plating with clear trivalent chromate finish

Applications include:

- Hydraulic Loaders
- Add-on hydraulic circuits
- Hydraulic tools

4000 Series Specifications:						
Body Size	Rated Flow (gpm)	Rated Pressure (psi)	Temperature	Body Material	Sleeve Type	Seal Material
1/4	3	3000	-40° F to +250° F	Steel	Manual Connect	Nitrile
3/8	6					
1/2	12					
3/4	28					
1	50					

Performance:

4000 Series (1/4", 3/8", 1/2")
Test Fluid: Oil - 200 SUS

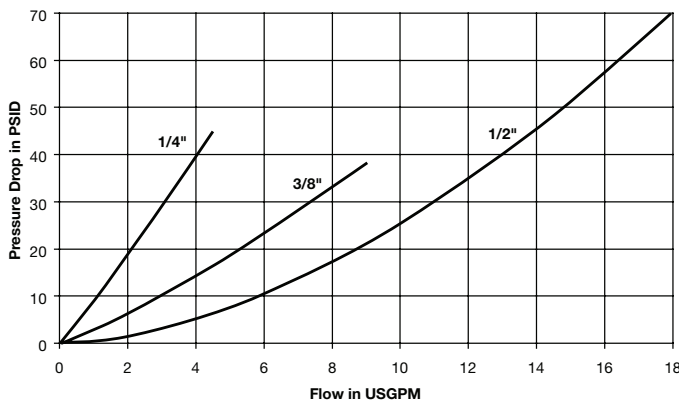

4000 Series (3/4" & 1")
Test Fluid: Oil - 200 SUS

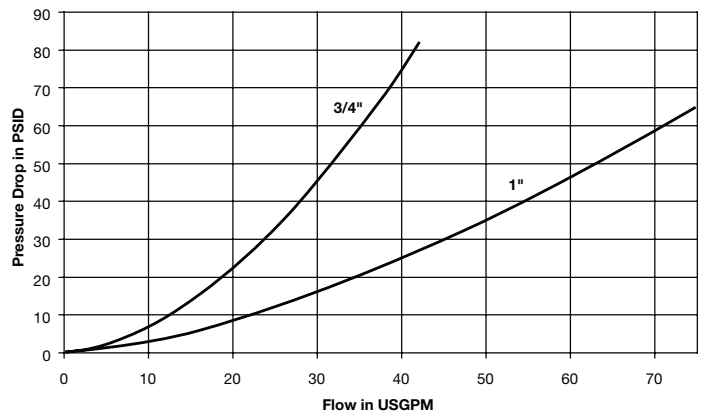

Optional Seal Materials:

(add code to part number)

Code	Description	Part Number Example
suffix W	Ethylene Propylene seal material- EPR	4050-4PW
suffix Y	Fluorocarbon seal material	4050-4PY
suffix Z	Neoprene seal material	4050-4PZ

Contact QCD for availability and additional options.
To select proper seal materials, see Fluid Compatibility Chart or contact QCD.



4000 Series Couplers



Body Size	Coupler Part Number	Port End	Valve Type	Length	Largest Diameter	Wrench Flats	Weight (lbs.)
1/4	4050-2P	1/4-18 NPTF	Poppet	2.18	1.06	0.88	0.24
1/4	4050-2P-T8M	3/4-16 ORB (Male)	Poppet	1.80	1.06	0.88	0.21
1/4	4050-T6	9/16-18 ORB	Poppet	2.18	1.06	0.88	0.27
1/4	4050P-T6*	9/16-18 ORB	Poppet	2.43	1.33	0.88	0.33
3/8	4050-3P	3/8-18 NPTF	Poppet	2.31	1.33	0.94	0.51
1/2	4050-4	1/2-14 NPTF	Ball	2.60	1.50	1.06	0.58
1/2	4050-4P	1/2-14 NPTF	Poppet	2.60	1.50	1.06	0.58
1/2	4050-5	3/4-14 NPTF	Ball	2.69	1.50	1.13	0.71
1/2	4050-5P	3/4-14 NPTF	Poppet	2.69	1.50	1.13	0.71
1/2	4050-15	3/4-16 ORB	Ball	2.81	1.50	1.06	0.64
1/2	4050-15P	3/4-16 ORB	Poppet	2.81	1.50	1.06	0.64
1/2	4050-16	7/8-14 ORB	Ball	2.75	1.50	1.06	0.59
1/2	4050-16P	7/8-14 ORB	Poppet	2.75	1.50	1.06	0.59
1/2	4050-29BSPP	1/2-14 BSPP	Ball	2.68	1.50	1.06	0.59
3/4	4150-5	3/4-14 NPTF	Ball	3.06	1.87	1.38	1.00
1	4050-6P	1-11 1/2 NPTF	Poppet	3.84	2.08	1.63	1.89

* Special Push/Pull Sleeve

8010 Series Nipples



Body Size	Nipple Part Number	Port End	Valve Type	Length	Exposed Length*	Largest Diameter	Wrench Flats	Weight (lbs.)
1/4	4010-2P	1/4-18 NPTF	Poppet	1.48	0.71	0.87	0.75	0.08
1/4	4010-T6	9/16-18 ORB	Poppet	1.60	0.81	0.87	0.75	0.09
3/8	4010-3P	3/8-18 NPTF	Poppet	1.60	0.80	1.08	0.94	0.16
1/2	8010-4	1/2-14 NPTF	Ball	1.95	1.09	1.23	1.06	0.20
1/2	8010-4P	1/2-14 NPTF	Poppet	1.95	1.09	1.23	1.06	0.20
1/2	8010-5	3/4-14 NPTF	Ball	2.14	1.28	1.44	1.25	0.25
1/2	8010-5P	3/4-14 NPTF	Poppet	2.14	1.28	1.44	1.25	0.25
1/2	8010-15	3/4-16 ORB	Ball	1.95	1.20	1.23	1.06	0.20
1/2	8010-15P	3/4-16 ORB	Poppet	1.95	1.20	1.23	1.06	0.20
1/2	8010-16	7/8-14 ORB	Ball	1.95	1.18	1.23	1.06	0.25
1/2	8010-16P	7/8-14 ORB	Poppet	1.95	1.18	1.23	1.06	0.25
1/2	8010-29BSPP	1/2-14 BSPP	Ball	1.95	1.09	1.18	1.06	0.25
3/4	4110-5	3/4-14 NPTF	Ball	1.81	1.23	1.52	1.31	0.50
1	4010-6P	1-11 1/2 NPTF	Poppet	2.79	1.49	1.88	1.63	0.62

* This dimension represents the portion of the nipple that is exposed when the nipple and coupler are connected.

WARNING: This product can expose you to chemicals including Lead, which is known to the State of California to cause cancer and birth defects or other reproductive harm. For more information go to www.P65Warnings.ca.gov



B Hydraulics



4050 Series Replacement O-Rings			
Body Size	Material	Part Number	Durometer
1/4	Nitrile	50001-113-0260	90
3/8	Nitrile	50001-116-0260	90
1/2	Nitrile	50001-211-0260	90
3/4	Nitrile	50001-215-0010	70
1	Nitrile	50001-218-0260	90

4000 Series Dust Caps and Plugs				
Body Size	Dust Plug (Coupler)	Color/Material	Dust Cap (Nipple)	Weight (lbs.)
1/4	5205-2M	Black Rubber	5209-2M	.02
3/8	5205-3M	Black Rubber	5209-3M	.03
1/2	5205-4M	Black Rubber	5209-4M	.04
1/2	5005-4	Steel w/Chain	5009-4	.21
1/2	5205-4M-BU	Blue Rubber	5209-4M-BU	.04
1/2	5205-4M-GR	Green Rubber	5209-4M-GR	.04
1/2	5205-4M-RE	Red Rubber	5209-4M-RE	.04
1/2	5205-4M-YE	Yellow Rubber	5209-4M-YE	.04
3/4	5205-5M	Black Rubber	5209-5M	.05
1	5205-6M	Black Rubber	5209-6M	.06



WARNING: This product can expose you to chemicals including Lead, which is known to the State of California to cause cancer and birth defects or other reproductive harm. For more information go to www.P65Warnings.ca.gov

Hydraulic Quick Couplings

General Purpose

4200 Series Couplers

ISO 5675 Nipples (1/2" size)

Push/pull/breakaway sleeve



The 4200 Series brings to the industry a proven design for use on agricultural machinery, construction equipment, and other rugged applications where a breakaway feature is desirable.

Features:

- 1/2" size accepts ISO 5675 universal tips
- Grooves in sleeve to accommodate retaining rings for bulkhead mounting
- One-handed push-to-connect operation when coupler is clamp mounted
- 1/2" body size couplers are compatible with 5001-4 and 5006-4 breakaway clamps
- Critical parts are hardened
- Ball and poppet valve options
- Protective zinc plating with clear trivalent chromate finish

Applications include:

- Hydraulic Loaders
- Add-on hydraulic circuits
- Implement breakaway
- Hydraulic tools



4200 Series Specifications:

Body Size	Rated Flow (gpm)	Rated Pressure (psi)	Temperature	Body Material	Sleeve Type	Seal Material
3/8	6	3000	-40° F to +250° F	Steel	Push/pull/breakaway	Nitrile
1/2	12					

Performance:

4200 Series (3/8" & 1/2")
Test Fluid: Oil - 200 SUS

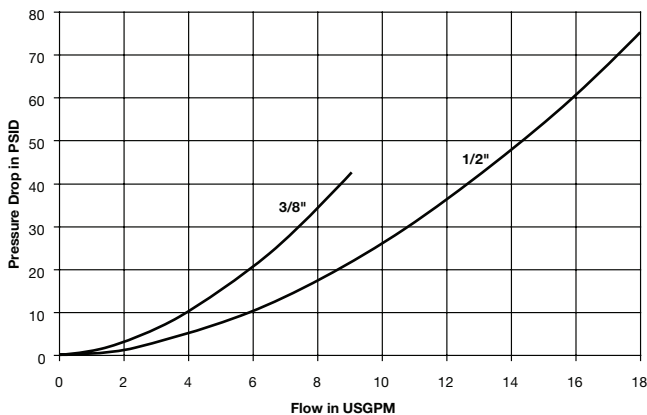

4200 Series Dust Caps and Plugs



Body Size	Dust Plug (Coupler)	Color/Material	Dust Cap (Nipple)	Weight (lbs.)
3/8	5205-3M	Black Rubber	5209-3M	.03
1/2	5205-4M	Black Rubber	5209-4M	.04
1/2	5005-4	Steel w/Chain	5009-4	.21
1/2	5205-4M-BU	Blue Rubber	5209-4M-BU	.04
1/2	5205-4M-GR	Green Rubber	5209-4M-GR	.04
1/2	5205-4M-RE	Red Rubber	5209-4M-RE	.04
1/2	5205-4M-YE	Yellow Rubber	5209-4M-YE	.04

Optional Seal Materials:

(add code to part number)

Code	Description	Part Number Example
suffix W	Ethylene Propylene seal material- EPR	4250-4PW
suffix Y	Fluorocarbon seal material	4250-4PY
suffix Z	Neoprene seal material	4250-4PZ

Contact QCD for availability and additional options.
To select proper seal materials, see Fluid Compatibility Chart or contact QCD.



4200 Series Couplers



Body Size	Coupler Part Number	Port End	Valve Type	Length	Largest Diameter	Wrench Flats	Weight (lbs.)
3/8	4250-3P	3/8-18 NPTF	Poppet	2.31	1.31	0.81	0.39
1/2	4250-4	1/2-14 NPTF	Ball	2.68	1.50	0.94	0.55
1/2	4250-4P	1/2-14 NPTF	Poppet	2.68	1.50	0.94	0.55
1/2	4250-15	3/4-16 ORB	Ball	2.68	1.50	0.94	0.55
1/2	4250-15P	3/4-16 ORB	Poppet	2.68	1.50	0.94	0.55

8010 Series Nipples



Body Size	Nipple Part Number	Port End	Valve Type	Length	Exposed Length*	Largest Diameter	Wrench Flats	Weight (lbs.)
3/8	4010-3P	3/8-18 NPTF	Poppet	1.60	0.80	1.08	0.94	0.16
1/2	8010-4	1/2-14 NPTF	Ball	1.95	1.09	1.23	1.06	0.20
1/2	8010-4P	1/2-14 NPTF	Poppet	1.95	1.09	1.23	1.06	0.20
1/2	8010-15	3/4-16 ORB	Ball	2.06	1.20	1.23	1.06	0.20
1/2	8010-15P	3/4-16 ORB	Poppet	2.06	1.20	1.23	1.06	0.20

* This dimension represents the portion of the nipple that is exposed when the nipple and coupler are connected.

8010 Series Nipples (Connect Under Pressure)



Body Size	Nipple Part Number	Port End	Valve Type	Length	Exposed Length*	Largest Diameter	Wrench Flats	Weight (lbs.)
1/2	8010-4P-DC	1/2-14 NPTF	DC Poppet	1.81	1.09	1.06	1.16	0.20
1/2	8010-15P-DC	3/4-16 ORB	DC Poppet	1.81	1.09	1.06	1.16	0.20

4250 Series Replacement O-Rings

Body Size	Material	Part Number	Durometer
3/8	Nitrile	50001-116-0260	90
1/2	Nitrile	50001-211-0260	90



WARNING: This product can expose you to chemicals including Lead, which is known to the State of California to cause cancer and birth defects or other reproductive harm. For more information go to www.P65Warnings.ca.gov



NS Series non-spill couplings are designed to minimize spillage and air inclusion when connecting or disconnecting. Couplers and nipples are steel with nitrile seals. 1/2 inch through 1 inch sizes utilize a PTFE back-up ring as additional support to the interface seal.

Features:

- Rated pressure up to 2500 psi
- Positive valve stop prevents flow checking
- Heat treated steel nipple and heavy duty sleeve withstand pressure surges
- Standard sleeve lock guards against accidental disconnection
- Couplings have protective zinc with clear trivalent chromate finish
- Standard end configurations include female pipe, straight thread ORB, and BSPP
- Alternative seal materials available

Applications:

- Hydraulic hand tools
- Utility equipment
- Mining equipment

Performance

NS Series (3/8" & 1/2")
Test Fluid: Oil - 200 SUS

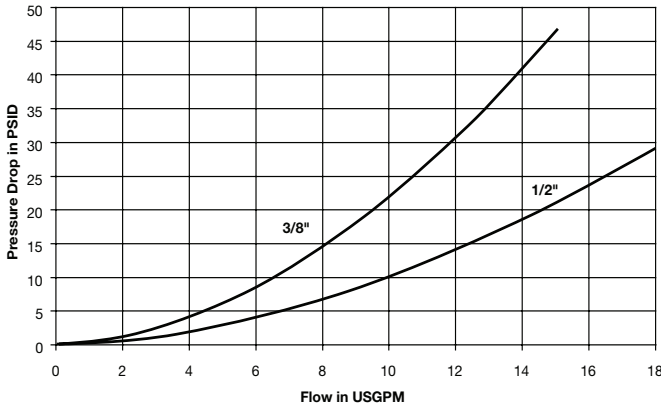

NS Series (3/4" & 1")
Test Fluid: Oil - 200 SUS

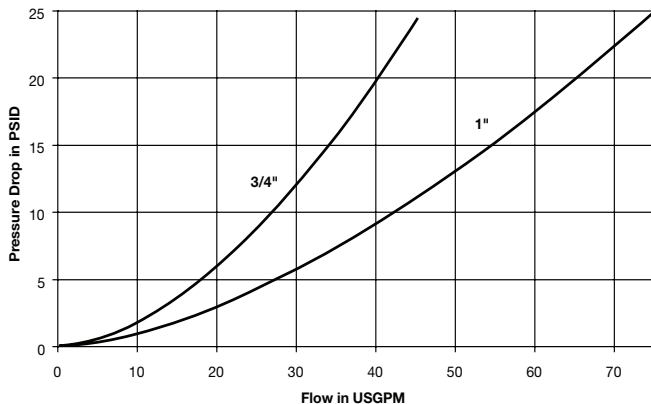

Specifications

Body Size	3/8	1/2	3/4	1
Rated Pressure (psi)	2,500			
Rated Flow (gpm)	10	12	30	50
Temperature Range (std seals)	-40° to +250°F			
Spillage (ml) (max. per disconnect)	0.020	0.070	0.150	0.220
Air Inclusion (ml) (max. per disconnect)	0.010	0.020	0.050	0.070

NS Series Dust Plug/Caps



Body Size	Dust Plug/Cap Rubber
3/8	NR-37
1/2	NR-50
3/4	NR-75
1	NR-100



NS Series Couplers



Body Size	Part Number Steel	Thread Size	Length	Largest Diameter	Wrench Flats	Weight (lbs.)
3/8	NS-371-6FP	3/8-18 NPSF	2.10	1.13	1.06	0.36
3/8	NS-371-6FB	G3/8 BSPP	2.10	1.13	1.06	0.38
3/8	NS-371-8FO	3/4-16UNF	2.20	1.13	1.06	0.40
1/2	NS-501-8FP	1/2-14 NPSF	2.88	1.56	1.25	0.84
1/2	NS-501-8FB	G1/2 BSPP	2.95	1.56	1.25	0.74
1/2	NS-501-10FO	7/8-14UNF	2.97	1.56	1.25	0.80
3/4	NS-751-12FP	3/4-14 NPSF	3.19	1.96	1.56	1.48
3/4	NS-751-12FB	G3/4 BSPP	3.38	1.96	1.56	1.54
3/4	NS-751-12FO	1 1/16-12UN	3.51	1.96	1.56	1.58
1	NS-1001-16FP	1-11 1/2 NPSF	3.70	2.25	1.75	2.35
1	NS-1001-16FB	G 1 BSPP	3.81	2.25	1.75	2.36
1	NS-1001-16FO	1 5/16-12UN	3.81	2.25	1.75	2.36

NS Series Nipples



Body Size	Part Number Steel	Thread Size	Overall Length	Exposed* Length	Largest Diameter	Wrench Flats	Weight (lbs.)
3/8	NS-372-6FP	3/8-18 NPSF	1.70	1.17	1.08	0.94	0.16
3/8	NS-372-6FB	G3/8 BSPP	1.78	1.25	1.08	0.94	0.16
3/8	NS-372-8FO	3/4-16UNF	1.91	1.38	1.23	1.06	0.20
1/2	NS-502-8FP	1/2-14 NPSF	1.81	0.69	1.23	1.06	0.20
1/2	NS-502-8FB	G1/2 BSPP	1.95	0.83	1.23	1.06	0.22
1/2	NS-502-10FO	7/8-14UNF	2.14	1.02	1.23	1.06	0.23
3/4	NS-752-12FP	3/4-14 NPSF	2.25	1.12	1.59	1.37	0.48
3/4	NS-752-12FB	G3/4 BSPP	2.47	1.34	1.59	1.37	0.54
3/4	NS-752-12FO	1 1/16-12UN	2.62	1.49	1.59	1.37	0.65
1	NS-1002-16FP	1-11 1/2 NPSF	2.64	1.54	1.88	1.62	0.72
1	NS-1002-16FB	G 1 BSPP	2.78	1.68	1.88	1.62	0.74
1	NS-1002-16FO	1 5/16-12UN	2.78	1.68	1.88	1.62	0.80

* This dimension represents the portion that is exposed when the nipple is inserted into the mating Parker Coupler.

Standard Port Configurations

- FP** - Female Pipe Thread
- FO** - Female Straight Thread
- FB** - Female British Standard Parallel Pipe

Optional Seal Materials (add code to part number):

Code	Description	Part Number Example
suffix -E5	Ethylene Propylene seal material (EPR)	NS-502-8FP-E5
suffix -E4	Fluorocarbon seal material	NS-502-8FP-E4

Contact QCD for availability and additional options.
To select proper seal materials, see Fluid Compatibility Chart or contact QCD.

WARNING: Products listed in these pages can expose you to chemicals including Lead, which is known to the State of California to cause cancer and birth defects or other reproductive harm. For more information go to www.P65Warnings.ca.gov





NSS couplings deliver high flow rates with excellent flow vs pressure drop characteristics to maintain optimum system performance and efficiency. Ideal for high-tech industry cooling applications, couplers and nipples are 316 stainless steel with ethylene propylene seals. Their compact body size and guided alignment save time and frustration when connecting fluid lines in confined spaces.

Features:

- Non-spill valving ensures minimal fluid loss and low air inclusion
- Corrosion resistant stainless steel construction
- Easy push to connect operation with guided alignment
- High flow and compact size
- Standard end configurations include female straight thread ORB, Push-Lok® hose barb, A-Lok, bulkhead and panel mount options
- Alternative seal materials available

Applications:

- Cooling lines
- Chemical transfer lines
- High purity systems
- Lab equipment

Specifications		
Body Size	3/8	1/2
Rated Pressure (psi)	2000	300
Rated Flow (gpm)	10	12
Temperature Range (std seals)	-70° to +250°F	
Standard Seal Material	Ethylene Propylene	Ethylene Propylene
Body/Sleeve/Valve Material	316 Stainless Steel	316 Stainless Steel
Spring Material	17-7 Stainless Steel	17-7 Stainless Steel
Locking Ball Material	303 Stainless Steel	303 Stainless Steel
Spillage (ml) (max. per disconnect)	0.020	0.070
Air Inclusion (ml) (max. per disconnect)	0.010	0.020

3/8" NSS vs 3/8" Instrumentation Coupler
Pressure Drop vs Flow

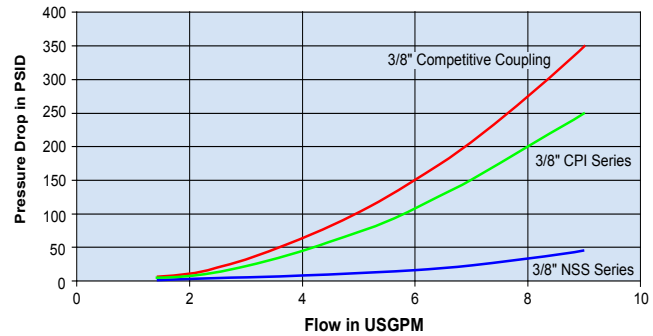

3/8" NSS vs 1/2" Instrumentation Coupler
Pressure Drop vs Flow

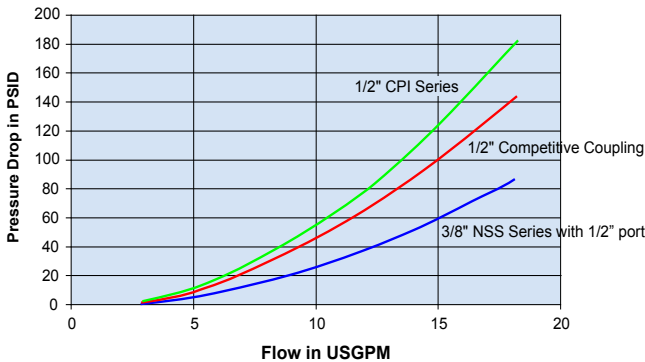

1/2" NSS vs 1/2" Instrumentation Coupler
Pressure Drop vs Flow

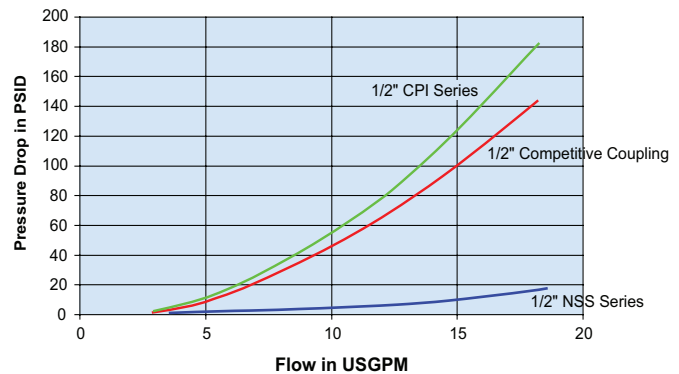



NSS Series Couplers - Female Thread

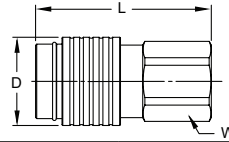

Body Size	Part Number	Thread Size	Length (in)	Largest Diameter (in)	Wrench Flats (in)	Weight (lbs)
3/8	NSS-371-6FO	9/16 - 18 UNF	2.25	1.13	0.94	0.35
3/8	NSS-371-8FO	3/4 - 16 UNF	2.38	1.13	0.94	0.35
1/2	NSS-501-10FO	7/8 - 14 UNF	2.99	1.40	1.25	0.80
1/2	NSS-501-12FO	1 1/16 - 12 UNF	3.10	1.40	1.25	0.80

NSS Series Couplers - Push-Lok® Hose Barb*

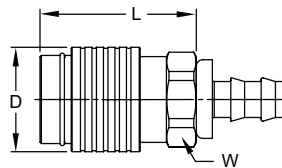

Body Size	Part Number	Hose ID (in)	Length** (in)	Largest Diameter (in)	Wrench Flats (in)	Weight (lbs)
3/8	NSS-371-6HB	3/8	1.70	1.13	0.94	0.30
3/8	NSS-371-8HB	1/2	1.62	1.13	0.94	0.30
1/2	NSS-501-8HB	1/2	2.23	1.40	1.25	0.80
1/2	NSS-501-12HB	3/4	2.23	1.40	1.25	0.80

* Push-Lok hose barbs are designed for use with Parker Push-Lok hose and do not require clamps.
** Length is to end of body hex and does not include fitting end.

NSS Series Couplers - A-Lok® Compression Fitting*

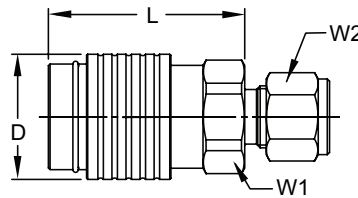

Body Size	Part Number	Port End	Length* (in)	Largest Diameter (in)	Wrench Flats 1 (in)	Wrench Flats 2 (in)	Weight (lbs)
3/8	NSS-371-6MA	3/8 A-Lok	1.75	1.13	0.94	0.69	0.35
3/8	NSS-371-8MA	1/2 A-Lok	1.67	1.13	0.94	0.88	0.37
1/2	NSS-501-8MA	1/2 A-Lok	2.23	1.40	1.25	0.88	0.80
1/2	NSS-501-12MA	3/4 A-Lok	2.23	1.40	1.25	1.13	0.80

* Length is to end of body hex and does not include fitting end.

NSS Series Couplers - A-Lok® Compression Fitting* / Bulkhead Mount

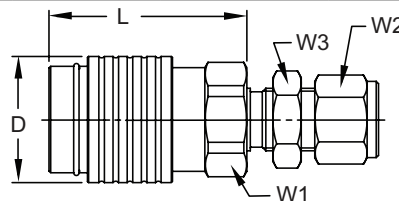

Body Size	Part Number	Port End	Length* (in)	Largest Diameter (in)	Wrench Flats 1 (in)	Wrench Flats 2 (in)	Wrench Flats 3 (in)	Weight (lbs)
3/8	NSS-371-6BMA	3/8 A-Lok	1.75	1.13	0.94	0.69	0.75	0.40
1/2	NSS-501-8BMA	1/2 A-Lok	2.06	1.40	1.25	0.88	0.94	0.80
1/2	NSS-501-12BMA	3/4 A-Lok	2.23	1.40	1.25	1.13	1.19	0.80

* Length is to end of body hex and does not include fitting end.



NSS Series Couplers - A-Lok® Compression Fitting* / Panel Mount

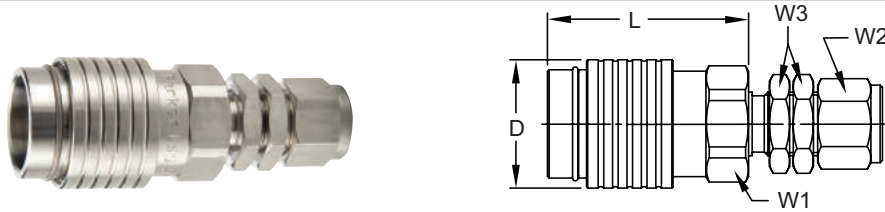

Body Size	Part Number	Port End	Length* (in)	Largest Diameter (in)	Wrench Flats 1 (in)	Wrench Flats 2 (in)	Wrench Flats 3 (in)	Weight (lbs)
3/8	NSS-371-6HMA	3/8 A-Lok	1.75	1.13	0.94	0.69	0.75	0.40
1/2	NSS-501-8HMA	1/2 A-Lok	2.23	1.40	1.25	0.88	0.94	0.80
1/2	NSS-501-12HMA	3/4 A-Lok	2.23	1.40	1.25	1.13	1.19	0.80

* Length is to end of body hex and does not include fitting end.

NSS Series Nipples - Female Thread



Body Size	Part Number	Thread Size	Length (in)	Largest Diameter (in)	Wrench Flats (in)	Weight (lbs)
3/8	NSS-372-6FO	9/16 - 18 UNF	1.84	1.02	0.94	0.20
3/8	NSS-372-8FO	3/4 - 16 UNF	1.99	1.02	0.94	0.20
1/2	NSS-502-10FO	7/8 - 14 UNF	2.99	1.40	1.25	0.80
1/2	NSS-502-12FO	1 1/16 - 12 UNF	3.11	1.40	1.25	0.80

NSS Series Nipples - Push-Lok® Hose Barb*

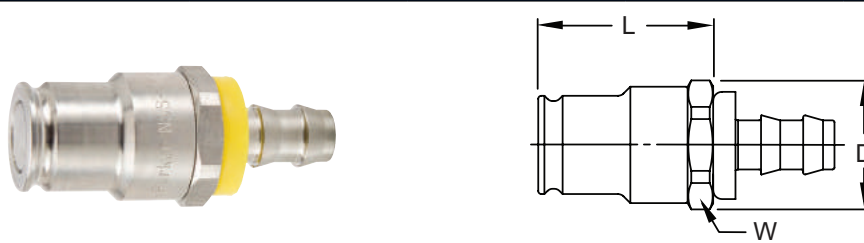

Body Size	Part Number	Hose ID (in)	Length** (in)	Largest Diameter (in)	Wrench Flats (in)	Weight (lbs)
3/8	NSS-372-6HB	3/8	1.37	1.02	0.94	0.15
3/8	NSS-372-8HB	1/2	1.37	1.02	0.94	0.15
1/2	NSS-502-8HB	1/2	1.38	1.38	1.25	0.25
1/2	NSS-502-12HB	3/4	2.23	1.38	1.25	0.25

* Push-Lok hose barbs are designed for use with Parker Push-Lok hose and do not require clamps.

** Length is to end of body hex and does not include fitting end.

Code	Coupler and Nipple Seal Material Options	Part Number Example
suffix N	Nitrile - NBR	NSS-371-6HMA-N
suffix F	Fluorocarbon - FKM	NSS-371-6HMA-F
suffix C	Neoprene - CR	NSS-371-6HMA-C
suffix G	GFTL Fluorocarbon - FKM	NSS-371-6HMA-G
suffix P	Perfluorolastomer - FFKM	NSS-371-6HMA-P
suffix L	Fluorosilicone - FVQM	NSS-371-6HMA-L

Contact QCD for availability and additional options.

To select proper seal materials, see Fluid Compatibility Chart or contact QCD.



NSS Series Nipples - A-Lok® Compression Fitting*



Body Size	Part Number	Port End	Length* (in)	Largest Diameter (in)	Wrench Flats 1 (in)	Wrench Flats 2 (in)	Weight (lbs)
3/8	NSS-372-6MA	3/8 A-Lok	1.39	1.02	0.94	0.69	0.20
3/8	NSS-372-8MA	1/2 A-Lok	1.39	1.02	0.94	0.88	0.22
1/2	NSS-502-8MA	1/2 A-Lok	2.23	1.38	1.25	0.88	0.25
1/2	NSS-502-12MA	3/4 A-Lok	2.23	1.38	1.25	1.13	0.25

* Length is to end of body hex and does not include fitting end.

NSS Series Nipples - A-Lok® Compression Fitting* / Bulkhead Mount

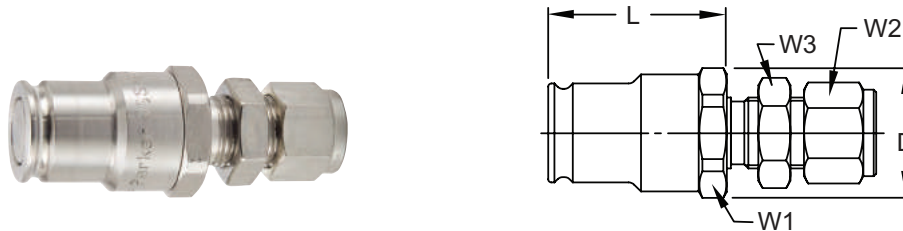

Body Size	Part Number	Port End	Length* (in)	Largest Diameter (in)	Wrench Flats 1 (in)	Wrench Flats 2 (in)	Wrench Flats 3 (in)	Weight (lbs)
3/8	NSS-372-6BMA	3/8 A-Lok	1.39	1.02	0.94	0.69	0.75	0.25
1/2	NSS-502-8BMA	1/2 A-Lok	1.99	1.38	1.25	0.88	0.94	0.25
1/2	NSS-502-12BMA	3/4 A-Lok	2.23	1.38	1.25	1.13	1.19	0.25

* Length is to end of body hex and does not include fitting end.

NSS Series Nipples - A-Lok® Compression Fitting* / Panel Mount

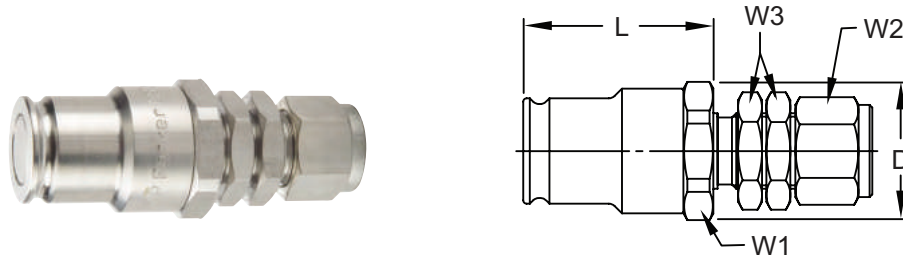

Body Size	Part Number	Port End	Length* (in)	Largest Diameter (in)	Wrench Flats 1 (in)	Wrench Flats 2 (in)	Wrench Flats 3 (in)	Weight (lbs)
3/8	NSS-372-6HMA	3/8 A-Lok	1.39	1.02	0.94	0.69	0.75	0.25
1/2	NSS-502-8HMA	1/2 A-Lok	2.23	1.38	1.25	0.88	0.94	0.25
1/2	NSS-502-12HMA	3/4 A-Lok	2.23	1.38	1.25	1.13	1.19	0.25

* Length is to end of body hex and does not include fitting end.



WARNING: This product can expose you to chemicals including Lead, which is known to the State of California to cause cancer and birth defects or other reproductive harm. For more information go to www.P65Warnings.ca.gov

Hydraulic Quick Couplings Non-Spill

FF/FC Series HTMA (3/8 size) Push to connect/sleeve lock



B Hydraulics



FF Series couplings eliminate spillage and air inclusion when connecting and disconnecting. The sleeve locking mechanism prevents accidental disconnection. 3/8" body size complies with Hydraulic Tool Manufacturers Association standards. FC nipples provide a connect-under-pressure option for trapped pressures up to 3000 psi on the nipple side.

Features

- Flush, non-spill valving
- Hardened steel sleeves and nipple bodies
- Locking sleeve
- Sleeve-Lok design now standard
- Blow-out resistant seal
- Connect-under-pressure FC nipple option
- Protective zinc nickel plating

Applications include:

- Hydraulic tools
- Mobile equipment
- Industrial hydraulics

Performance

FF Series (1/4", 3/8", 1/2")
Test Fluid: Oil - 200 SUS

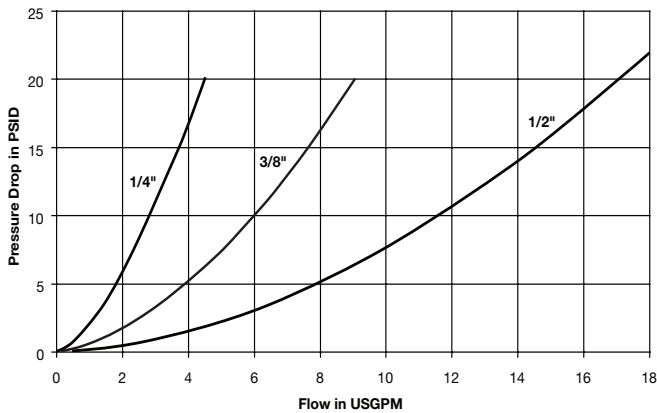

FF Series (3/4" & 1")
Test Fluid: Oil - 200 SUS

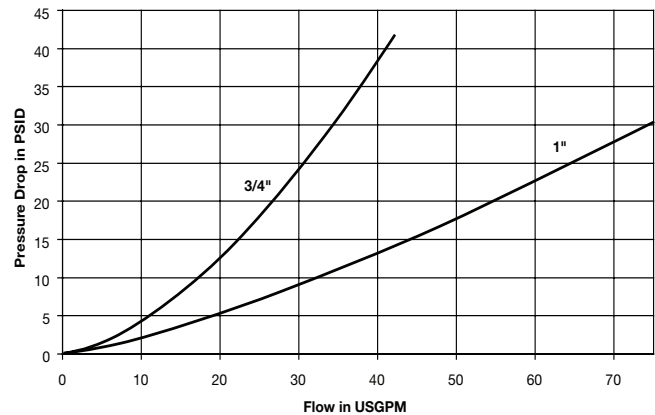

FF Series Specifications

Body Size	Rated Pressure (psi)	Rated Flow (gpm)	Temperature Range	Spillage (ml) max. per disconnect	Air Inclusion (ml) max. per connect	Body Material	Sleeve Type	Seal Material
1/4	5000	3	-40° to +250°F	.015	.020	Steel	Push to Connect	Nitrile/ Polyurethane
3/8	5000	6		.015	.020			
1/2	3000	12		.080	.070			
3/4	3000	28		.150	.100			
1	3000	50		.200	.150			



FF Series Couplers

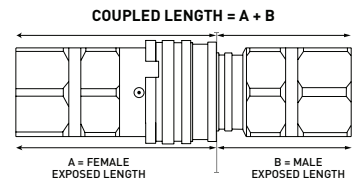

Body Size	Coupler Part Number	Port End	Length	Coupled Length	Largest Diameter	Wrench Flats	Weight (lbs.)
1/4	FF-251-4FP	1/4-18 NPSF	1.79		1.06	25 mm	0.23
1/4	FF-251-4MP	1/4-18 NPTF	1.84		1.06	25 mm	0.24
1/4	FF-251-6FO	9/16-18 UNF	1.91		1.06	25 mm	0.23
3/8	FEM-371-6FP	3/8-18 NPTF	3.06	5.02	1.26	30 mm	0.77
3/8	FEM-371-8FP	1/2-14 NPTF	3.17	5.23	1.26	30 mm	0.75
3/8	FEM-371-6FB	3/8-19 BSPP	3.06	5.02	1.31	30 mm	0.75
3/8	FEM-371-8FB	G1/2 BSPP	3.17	5.23	1.31	30 mm	0.75
3/8	FEM-371-8FO	3/4-16 UNF	3.06	5.02	1.26	30 mm	0.74
1/2	FF-501-8FP	1/2-14 NPSF	3.00		1.54	32 mm	0.88
1/2	FF-501-10FO	7/8-14 UNF	3.00		1.54	32 mm	1.05
3/4	FF-751-12FP	3/4-14 NPSF	3.50		1.94	45 mm	1.84
3/4	FF-751-12FO	1 1/16-12 UNF	3.75		1.94	45 mm	1.93
1	FF-1001-16FP	1-11 1/2NPSF	4.14		2.25	48 mm	2.64
1	FF-1001-16FO	1 5/16-12UNF	4.24		2.25	48 mm	2.68

FF Series Nipples

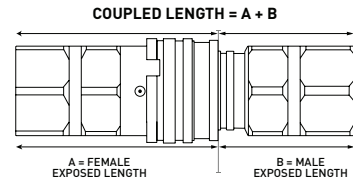

Body Size	Nipple Part Number	Port End	Length	Coupled Length	Exposed Length*	Largest Diameter	Wrench Flats	Weight (lbs.)
1/4	FF-252-4FP	1/4-18 NPSF	1.66		1.15	1.06	25 mm	0.16
1/4	FF-252-4MP	1/4-18 NPTF	1.72		1.18	1.06	25 mm	0.26
1/4	FF-252-6FO	9/16-18 UNF	1.66		1.15	1.06	25 mm	0.16
3/8	FEM-372-6FP	3/8-18 NPTF	2.59	5.02		1.26	30 mm	0.48
3/8	FEM-372-8FP	1/2-14 NPSF	2.69	5.23		1.26	30 mm	0.48
3/8	FEM-372-6FB	3/8-19 BSPP	2.59	5.02		1.26	30 mm	0.48
3/8	FEM-372-8FB	G1/2 BSPP	2.69	5.22		1.26	30 mm	0.47
3/8	FEM-372-8FO	3/4-16 UNF	2.59	5.02		1.26	30 mm	0.45
1/2	FF-502-8FP	1/2-14 NPSF	2.75		2.11	1.38	32 mm	0.42
1/2	FF-502-10FO	7/8-14 UNF	2.75		2.07	1.38	32 mm	0.44
3/4	FF-752-12FP	3/4-14 NPSF	3.38		2.47	1.73	45 mm	1.00
3/4	FF-752-12FO	1 1/16-12 UNF	3.58		2.47	1.73	45 mm	1.02
1	FF-1002-16FP	1-11 1/2 NPSF	3.85		2.60	2.17	48 mm	1.60
1	FF-1002-16FO	1 5/16-12UNF	3.85		2.60	2.17	48 mm	1.70

Standard Port Configurations: **FP** - Female Pipe Thread **FO** - Female Straight Thread
MP - Male Pipe Thread **FB** - Female British Standard Pipe Parallel

* This dimension represents the portion of the nipple that is exposed when the nipple and coupler are connected.

WARNING: This product can expose you to chemicals including Lead, which is known to the State of California to cause cancer and birth defects or other reproductive harm. For more information go to www.P65Warnings.ca.gov





Optional Seal Materials:

(add code to part number)

Code	Description	Part Number Example
suffix -E5	Ethylene Propylene seal material (EPR)	FF-501-8FP-E5
suffix -E4	Fluorocarbon seal material	FF-501-8FP-E4

Optional seals include O-ring & Back-Up Ring, not Anti-Blow Out bonded seal. Contact QCD for availability and additional options. To select proper seal materials, see Fluid Compatibility Chart or contact QCD.

B Hydraulics

FF Series Repair Kits				Spline Tool
1/4" Nipple	FF-252-KIT	FF-252-KIT-E4	FF-252-KIT-E5	-
1/4" Coupler	FF-251-KIT	FF-251-KIT-E4	FF-251-KIT-E5	FF/FS-251-TOOL
3/8" Nipple	FF-372-KIT	FF-372-KIT-E4	FF-372-KIT-E5	-
3/4" Nipple	FF-752-KIT	FF-752-KIT-E4	FF-752-KIT-E5	-
3/4" Coupler	FF-751-KIT	FF-751-KIT-E4	FF-751-KIT-E5	FF/FS-751-TOOL
1" Nipple	FF-1002-KIT	FF-1002-KIT-E4	FF-1002-KIT-E5	-
1" Coupler	FF-1001-KIT	FF-1001-KIT-E4	FF-1001-KIT-E5	FF/FS-1001-TOOL

Dust Caps - FF Series			
	Body Size	Coupler Dust Cap - Rubber	Nipple Dust Cap - Rubber
	1/4	FR-25	FR-25
	3/8	NR-50	NR-37
	1/2	FR-501	FR-502
	3/4	FR-751	FR-752
	1	FR-1001	FR-1002



Connect Under Pressure Operation

FC Series products operate slightly different from traditional non-spill couplings. With no pressure in the coupler and up to 3000 PSI of trapped pressure in the nipple, begin to couple the mating halves. Delay momentarily during connection to allow trapped pressure to equalize with the mating half before completing the connection.

FC Series nipples provide a connect-under-pressure option for trapped pressures up to 3000 psi on the nipple side.

Features:

- Connect-under-pressure nipple
- Flush, non-spill valving
- Hardened locking surface
- Blow-out resistant seal
- Protective zinc plating with clear trivalent chromate finish

Applications include:

- Hydraulic tools

FC Series Specifications					
Body Size	Rated Pressure (psi)	Rated Connect-Under-Pressure Capability	Rated Flow (gpm)	Spillage (ml) max. per disconnect	Air Inclusion (ml) max. per connect
3/8	3000	3000	6	.015	.020
1/2	3000	3000	12	.020	.070
3/4	3000	1500	26	.150	.100

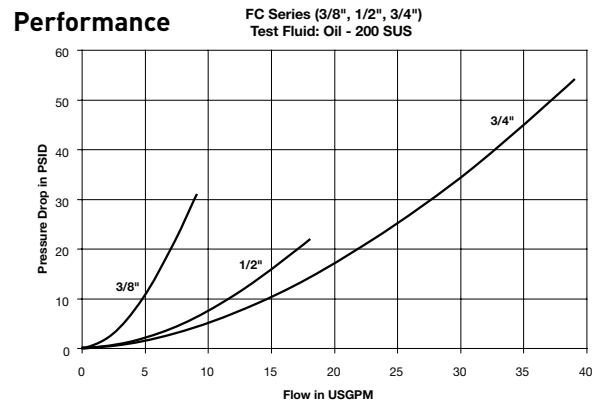

FC Series Connect Under Pressure Nipples



Body Size	Part Number	Mating Half	Port End	Length	Exposed Length*	Largest Diameter	Wrench Flats	Weight (lbs.)
3/8	FC-372-6FP	FF-371	3/8-18 NPSF	3.30	2.58	1.16	1.062	0.45
3/8	FC-372-8FO	FF-371	3/4-16 UNF	3.30	2.58	1.16	1.062	0.42
3/8	FC-372-8FP	FF-371	1/2-14 NPSF	3.30	2.58	1.16	1.062	0.42
1/2	FC-502-8FP	FF-501	1/2-14 NPSF	3.46	2.65	1.22	1.125	0.53
1/2	FC-502-10FO	FF-501	7/8-14 UNF	3.46	2.65	1.22	1.125	0.52
3/4	FC-752-12FO	FF-751	1 1/16-12 UNF	4.81	3.72	1.65	1.500	1.32
3/4	FC-752-12FP	FF-751	3/4-14 NPSF	4.81	3.72	1.65	1.500	1.34

Standard Port Configurations: FP - Female Pipe Thread FO - Female Straight Thread

* This dimension represents the portion of the nipple that is exposed when the nipple and coupler are connected.



WARNING: This product can expose you to chemicals including Lead, which is known to the State of California to cause cancer and birth defects or other reproductive harm. For more information go to www.P65Warnings.ca.gov



FEM Series couplings meet or exceed ISO 16028 design and performance requirements. The flush valves eliminate spillage and air inclusion when connecting and disconnecting. Coupler and nipple bodies have a modular design with increased flexibility for end port options. FEC nipples provide a connect-under-pressure option for trapped residual pressure.

Features

- Flush, non-spill valving
- Global interchangeability with other ISO 16028 compliant couplings
- Hardened nipple bodies
- Sleeve-Lok design standard
- Connect-under-pressure FEC nipple option
- Protective zinc nickel plating

Applications include:

- Skid loader attachments
- Hydraulic tools

Materials of Construction

- Body:** Steel
Finish: 1/4", 5/8" to 1" Zinc with clear trivalent chromate
 3/8" & 1/2" Zinc Nickel
Valve: Flush face valving
Seal: Polyurethane and Nitrile

Performance

FEM Series (1/4", 3/8" & 1/2")
Test Fluid: Oil - 150 SUS

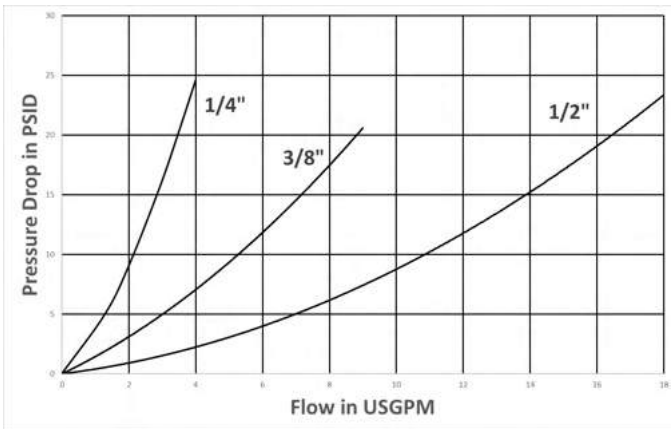

FEM Series (5/8", 3/4" & 1")
Test Fluid: Oil - 150 SUS

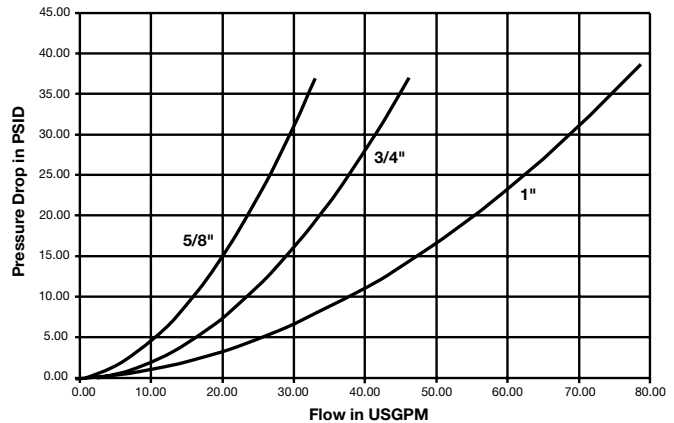

FEM Series Specifications

Body Size	Rated Pressure (psi)	Rated Flow (gpm)	Temperature Range	Spillage (ml) max. per disconnect	Air Inclusion (ml) max. per connect	Body Material	Sleeve Type	Seal Material
1/4	4568	3	-22° to +212°F	.015	.020	Steel	Push to Connect	Polyurethane and Nitrile
3/8	5000	6		.015	.020			
1/2	5000	12		.020	.070			
5/8	3625	20		.030	.070			
3/4	3625	26		.150	.100			
1	2900	50		.200	.150			



FEM Series Couplers							
Body Size	Coupler Part Number	Port End	Length	Coupled Length (when connected to corresponding nipple)	Largest Diameter	Wrench Flats	Weight (lbs.)
1/4	FEM-251-4FP	1/4-18 NPTF	1.96	3.98	1.16	27mm	0.52
1/4	FEM-251-6FO	9/16-18 UNF	2.08	4.06	1.16	27mm	0.51
3/8	FEM-371-6FP	3/8-18 NPTF	3.06	5.02	1.26	30 mm	0.77
3/8	FEM-371-8FO	3/4-16 UNF	3.06	5.02	1.26	30 mm	0.74
3/8	FEM-371-8FB	G1/2 BSPP	3.17	5.23	1.31	30 mm	0.75
1/2	FEM-501-8FP	1/2-14 NPTF	3.26	5.74	1.59	36 mm	1.22
1/2	FEM-501-8FO	3/4-16 UNF	3.26	5.74	1.59	36 mm	1.22
1/2	FEM-501-8FB	G1/2 BSPP	3.07	5.35	1.59	36 mm	1.14
1/2	FEM-501-10FO	7/8-14 UNF	3.08	5.38	1.59	36 mm	1.12
1/2	FEM-501-12FO	1 1/16-12 UNF	3.26	5.74	1.59	36 mm	1.11
1/2	FEM-501-12FB	G3/4 BSPP	3.25	5.71	1.59	36 mm	1.14
5/8	FEM-621-12FO	1 1/16-12 UNF	3.70	5.64	1.69	40 mm	1.34
3/4	FEM-751-12FP	3/4-14 NPTF	3.95	6.00	1.97	46 mm	1.98
3/4	FEM-751-12FO	1 1/16-12 UNF	3.95	6.20	1.97	46 mm	2.00
1	FEM-1001-16FP	1-11 1/2-NPTF	4.21	6.79	2.36	55 mm	3.08
1	FEM-1001-16FO	1 5/16-12 UNF	4.21	6.79	2.36	55 mm	3.03

FEM Series Couplers - 90 Degree							
Body Size	Coupler Part Number	Port End	Length	Coupled Length (when connected to corresponding nipple)	Largest Diameter	Wrench Flats	Weight (lbs.)
1/2	FEM-501-C6FP	3/8-18 NPTF	3.26	5.74	1.59	32 mm	1.187
1/2	FEM-501-C8FO	3/4-16 ORB	3.25	5.71	1.59	36 mm	1.187

FEM Series Couplers - Bulkhead							
Body Size	Coupler Part Number	Port End	Length	Coupled Length (when connected to corresponding nipple)	Largest Diameter	Wrench Flats	Weight (lbs.)
1/2	FEM-501-10BMF	7/8-14 UNF	4.02	6.32	1.54	32 mm	1.07
1/2	FEM-501-10BMS	1-14 UNS	4.02	6.32	1.59	36 mm	1.16

Code	Description	Part Number Example
suffix -E5	Ethylene Propylene seal material (EPR)	FEM-501-8FP-E5
suffix -E4	Fluorocarbon seal material	FEM-501-8FP-E4

Contact QCD for availability and additional options.

To select proper seal materials, see Fluid Compatibility Chart or contact QCD.



WARNING: This product can expose you to chemicals including Lead, which is known to the State of California to cause cancer and birth defects or other reproductive harm. For more information go to www.P65Warnings.ca.gov



FEM Series Nipples

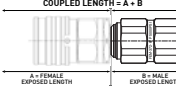
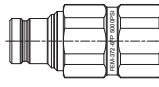

Body Size	Nipple Part Number	Port End	Length	Coupled Length (when connected to corresponding coupler)	Largest Diameter	Wrench Flats	Weight (lbs.)
1/4	FEM-252-4FP	1/4-18 NPTF	1.71	3.98	0.96	22 mm	0.20
1/4	FEM-252-6FO	9/16-18 UNF	1.95	4.06	0.96	22 mm	0.19
3/8	FEM-372-6FP	3/8-18 NPTF	2.59	5.02	1.26	30 mm	0.48
3/8	FEM-372-8FO	3/4-16 UNF	2.59	5.02	1.26	30 mm	0.45
3/8	FEM-372-8FB	G1/2 BSPP	2.69	5.22	1.26	30 mm	0.47
1/2	FEM-502-8FP	1/2-14 NPTF	3.13	5.74	1.57	36 mm	0.84
1/2	FEM-502-8FO	3/4-16 UNF	3.13	5.74	1.57	36 mm	0.85
1/2	FEM-502-8FB	G1/2 BSPP	2.95	5.35	1.57	36 mm	0.77
1/2	FEM-502-10FO	7/8-14 UNF	2.95	5.38	1.57	36 mm	0.75
1/2	FEM-502-12FO	1 1/16-12 UN	3.13	5.74	1.57	36 mm	0.74
1/2	FEM-502-12FB	G3/4 BSPP	3.13	5.71	1.57	36 mm	0.76
5/8	FEM-622-12FO	1 1/16-12 UN	3.09	5.64	1.57	36 mm	0.72
3/4	FEM-752-12FP	3/4-14 NPTF	3.38	6.00	1.97	46 mm	1.17
3/4	FEM-752-12FO	1-1/16 12 UN	3.38	6.20	1.974	46 mm	1.20
1	FEM-1002-16FP	1-11 1/2 NPTF	3.85	6.79	2.36	55 mm	1.94
1	FEM-1002-16FO	1-5/16 12 UN	3.85	6.79	2.36	55 mm	1.90

FEM Series Nipples - 90 Degree

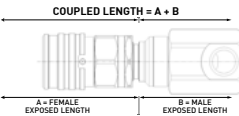

Body Size	Coupler Part Number	Port End	Length	Coupled Length (when connected to corresponding nipple)	Largest Diameter	Wrench Flats	Weight (lbs.)
1/2	FEM-502-C6FP	3/8-18 NPTF	3.13	5.74	1.57	36 mm	.82
1/2	FEM-502-C8FO	3/4-16 ORB	3.13	5.71	1.57	36 mm	.82

FEM Series Nipples - Bulkhead

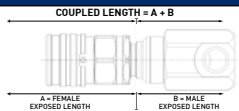

Body Size	Nipple Part Number	Port End	Length	Coupled Length (when connected to corresponding nipple)	Largest Diameter	Wrench Flats	Weight (lbs.)
1/2	FEM-502-10BMF	7/8-14 UNF	3.85	7.24	1.38	31.75 mm	.84
1/2	FEM-502-10BMS	1-14 UNS	3.85	7.24	1.38	31.75 mm	.84

Dust Caps - FEM Series



Body Size	Nipple Dust Cap	Coupler Dust Cap	Material	Body Size	Nipple Dust Cap	Coupler Dust Cap	Material
1/4	CFE-252-PN	PFE-251-PN	PVC	5/8	CFE-622-PN	PFE-621-PN	PVC
3/8	CFE-372-PN	PFE-371-PN	PVC	3/4	CFE-752-PN	PFE-751-PN	PVC
1/2	CFE-502-PN	PFE-501-PN	PVC	1	CFE-1002-PN	PFE-1001-PN	PVC

Standard Port Configurations: **FP** - Female Pipe Thread **FO** - Female Straight Thread **BMF** - Bulkhead Flare **BMS** - Bulkhead Face Seal
FB - Female British Standard Parallel Pipe Other Fitting Port Configurations available upon request.

* This dimension represents the portion of the nipple that is exposed when the nipple and coupler are connected.



Applications

Parker FEC Series nipple provide connect-under-pressure capability with up to 3000 PSI of trapped pressure in the nipple and are ideal for applications where residual pressure makes reconnect difficult. Utilized primarily in the construction equipment market, FEC Series products are commonly found on hydraulic attachments used in skid steer applications. The FEC Series mates with the FEM Series interface ISO 16028 couplers.

Features:

- Connect-Under-Pressure nipple
- Hardened locking surface
- Steel construction, Chromium-6 Free plating for corrosion resistance
- Anti blowout bonded nipple seal
- Flush face valving

Connect Under Pressure Operation

FEC Series products operate slightly different from traditional non-spill couplings. With no pressure in the coupler and up to 3000 PSI of trapped pressure in the nipple, begin to couple the mating halves. Delay momentarily during connection to allow trapped pressure to equalize with the mating half before completing the connection.

FEC Series Specifications					
Body Size	Rate Pressure (psi)	Rated Connect-Under-Pressure Capability	Rated Flow (gpm)	Spillage (ml) max. per disconnect	Air Inclusion (ml) max. per connect
1/2	3625	3000	12	.020	.070
5/8	3625	1700	20	.003	.070
3/4	3625	1500	26	.150	.100

Performance

FEC Series (1/2", 5/8", 3/4")
Test Fluid: Oil - 200 SUS

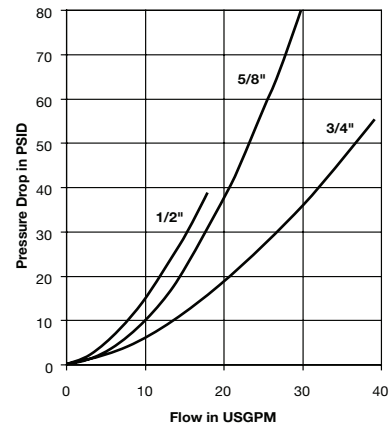

FEC Series Connect Under Pressure Nipples

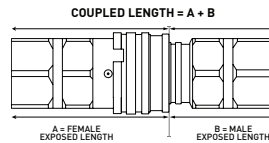

Body Size	Part Number	Mating Half	Port End	Length	Coupled Length (when connected to corresponding nipple)	Largest Diameter	Wrench Flats	Weight (lbs.)
1/2	FEC-502-8FP	FEM-501	1/2-14 NPTF	3.50	5.82	1.22	1.125	-
1/2	FEC-502-10FO	FEM-501	7/8-14 UNF	3.50	5.82	1.22	1.125	-
1/2	FEC-502-12FO	FEM-501	1 1/16-12 UNF	3.79	6.36	1.65	1.500	-
5/8	FEC-622-12FO	FEM-621	1 1/16-12 UN	3.39	5.94	1.65	1.500	-
3/4	FEC-752-12FO	FEM-751	1 1/16-12 UN	3.76	6.58	1.65	1.500	-

Standard Port Configurations: FP - Female Pipe Thread FO - Female Straight Thread

* This dimension represents the portion of the nipple that is exposed when the nipple and coupler are connected.



WARNING: This product can expose you to chemicals including Lead, which is known to the State of California to cause cancer and birth defects or other reproductive harm. For more information go to www.P65Warnings.ca.gov



FH Series high pressure, non-spill couplings have flush valves and are designed to minimize spillage and air inclusion when connecting or disconnecting. Couplers and nipples are steel with nitrile seals. Available in 3/8 inch size only, with red finish for easy identification. Will not connect with lower pressure flush face couplings.

Features:

- Rated pressure up to 10,000 psi
- Push to connect operation
- Red finish on nipple body and coupler sleeve
- Standard sleeve lock guards against accidental disconnection
- Not interchangeable with lower pressure flush face couplings
- Standard end configurations include female pipe, male pipe, and BSPP threads
- Alternative seal materials available

Applications:

- Hydraulic crimpers, cutters, benders, clamps, wedges
- Rescue equipment
- High pressure test equipment

Performance

FH Series (3/8")
Test Fluid: Oil - 200 SUS

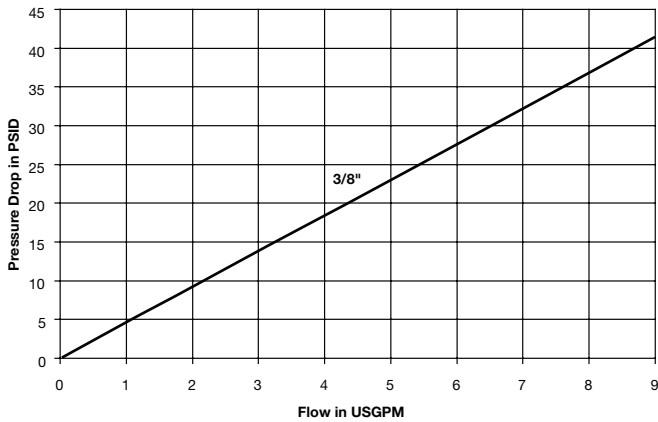

Specifications

Body Size	3/8
Rated Pressure (PSI)	10,000
Rated Flow (GPM)	6
Temperature Range	-40° to +250° F
Spillage (ML) (max. per disconnect)	.020
Air Inclusion (ML) (max. per connect)	.070

Materials of Construction

Body	Steel
Finish	Chromium-6 Free plating
Valve	Flush Face Valves
Seal	Anti blow-out Nitrile/PTFE bonded seal (nipple only)

Optional Seal Materials:

(add code to part number)

Code	Description	Part Number Example
suffix -E5	Ethylene Propylene seal material (EPR)	FH-371-6FP-E5
suffix -E4	Fluorocarbon seal material	FH-371-6FP-E4

Optional seals include O-ring & Back-Up Ring, not Anti-Blow Out bonded seal. Contact QCD for availability and additional options. To select proper seal materials, see Fluid Compatibility Chart or contact QCD.



Couplers



Body Size	Part Number Steel	Thread Size	Length	Largest Diameter	Wrench Flats	Weight (lbs.)
3/8	FH-371-6FP	3/8 -18 NPTF	2.63	1.23	1.12	0.44
3/8	FH-371-6MP	3/8 -18 NPTF	2.85	1.23	1.12	0.45
3/8	FH-371-6FB	G3/8 -BSPP	2.63	1.23	1.12	0.45

Nipples



Body Size	Part Number Steel	Thread Size	Length	Largest Diameter	Wrench Flats	Weight (lbs.)
3/8	FH-372-6FP	3/8-18 NPTF	2.12	1.23	1.00	0.26
3/8	FH-372-6FB	G3/8 -BSPP	2.12	1.23	1.00	0.28

Standard Port Configurations: **FP** - Female Pipe Thread **MP** - Male Pipe Thread **FB** - Female British Parallel Pipe

FH Series Dust Caps



Body Size	Coupler Dust Cap - Rubber	Nipple Dust Cap - Rubber
3/8	NR-50	NR-37



WARNING: This product can expose you to chemicals including Lead, which is known to the State of California to cause cancer and birth defects or other reproductive harm. For more information go to www.P65Warnings.ca.gov



FS Series dry disconnect couplings are ideal for closed system transfer and dispensing of chemicals and other fluids. The flush valves eliminate spillage and air inclusion when connecting and disconnecting to result in minimal environmental contamination.

Features:

- Flush, non-spill valves enable ease of cleaning
- 316 stainless steel material for chemical compatibility
- Push to connect operation
- Fluorocarbon standard seal material with options available

Applications include:

- Chemical dispensing systems
- Chemical processing
- Food processing
- Corrosive media transfer

Materials of Construction

- Machined Parts:** Stainless Steel, AISI type 316
Springs: Stainless Steel, AISI type 316.
Locking Balls: 1/4 - 3/8": 302 SS;
 1/2 - 3/4": 316 SS
 1": 440 SS
Backup Washers: PTFE
Elastomer Seals: Fluorocarbon is standard.
 Wide range is available.

Specifications					
Body Size	Rated Pressure (psi)	Rated Flow (gpm)	Spillage (ml) max. per disconnect	Air Inclusion (ml) max. per connect	CV
1/4	2000	3	.015	.010	0.90
3/8	2000	6	.015	.020	1.80
1/2	2000	12	.020	.070	3.00
3/4	2000	28	.150	.100	7.00
1	2000	50	.250	.182	10.1

Temperature Range (continuous)		
Part No. Seal Suffix	Seal Compound	Temp° F Rating
None*	Fluorocarbon	-15 to 400
E5	Ethylene Propylene (EPR)	-65 to 300
E1	Nitrile	-40 to 250
E35	Perfluoroelastomer (Contact QCD)	-20 to 600

*Fluorocarbon is standard seal.
 Contact QCD for availability and additional options.
 To select proper seal materials, see Fluid Compatibility Chart or contact QCD.

Optional Seal Materials:

Code	Description	Part Number Example
suffix -E5	Ethylene Propylene seal material- EPR)	FS-371-6FP-E5
suffix -E12	Neoprene seal material	FS-371-6FP-E12

Performance Flow Data

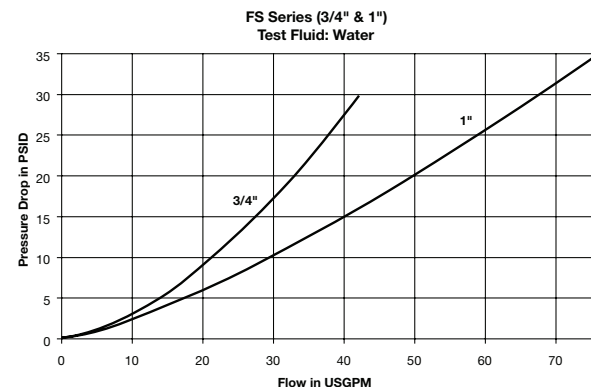
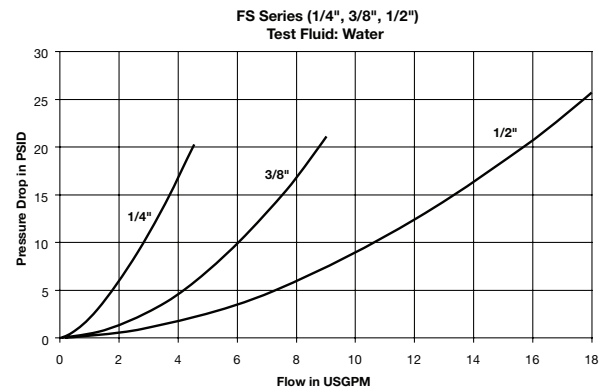



FS Series Couplers - Female Thread



Body Size	Coupler Part Number	Port End	Length	Largest Diameter	Wrench Flats	Weight (lbs.)
1/4	FS-251-4FP	1/4-18 NPT	1.79	1.06	1.00	0.25
1/4	FS-251-4MP	1/4-18 NPTF	2.00	1.06	1.00	0.25
1/4	FS-251-6FO	9/16-18UNF	1.92	1.06	1.00	0.24
3/8	FS-371-6FP	3/8-18 NPT	2.52	1.30	1.06	0.58
3/8	FS-371-8FO	3/4-16 UNF	2.83	1.30	1.06	0.63
1/2	FS-501-8FP	1/2-14 NPT	2.74	1.58	1.38	0.92
1/2	FS-501-10FO	7/8-14 UNF	2.86	1.58	1.38	0.96
3/4	FS-751-12FP	3/4-14 NPT	3.63	1.99	1.75	2.00
3/4	FS-751-12FO	1-1/16-12 UNF	3.73	1.99	1.75	2.04
1	FS-1001-16FP	1-11 1/2 NPT	4.14	2.25	1.87	2.76
1	FS-1001-16FO	1-5/16-12 UNF	4.24	2.25	1.87	2.80

FS Series Nipples - Female Thread



Body Size	Coupler Part Number	Port End	Overall Length	Exposed Length*	Largest Diameter	Wrench Flats	Weight (lbs.)
1/4	FS-252-4FP	1/4-18 NPT	1.66	1.14	1.06	1.00	0.18
1/4	FS-252-4MP	1/4-18 NPTF	1.87	1.34	1.06	1.00	0.18
1/4	FS-252-6FO	9/16-18 UNF	1.78	1.26	1.06	1.00	0.17
3/8	FS-372-6FP	3/8-18 NPT	2.31	1.71	1.08	0.94	0.26
3/8	FS-372-8FO	3/4-16 UNF	2.45	1.71	1.19	1.06	0.30
1/2	FS-502-8FP	1/2-14 NPT	2.75	2.03	1.30	1.12	0.44
1/2	FS-502-10FO	7/8-14 UNF	2.85	2.11	1.30	1.12	0.48
3/4	FS-752-12FP	3/4-14 NPT	3.38	2.37	1.65	1.50	1.02
3/4	FS-752-12FO	1-1/16-12 UNF	3.38	2.37	1.65	1.50	1.02
1	FS-1002-16FP	1-11 1/2 NPT	3.89	2.60	2.17	1.87	1.60
1	FS-1002-16FO	1-5/16 12 UNF	3.89	2.51	2.17	1.87	1.64

Standard Port Configurations: **FP** - Female Pipe Thread **MP** - Male Pipe Thread **FO** - Female Straight Thread

* This dimension represents the portion of the nipple that is exposed when the nipple and coupler are connected.

Dust Caps - FS Series



Body Size	Coupler Dust Cap - Rubber	Nipple Dust Cap - Rubber
1/4	FR-25	FR-25
3/8	NR-50	NR-37
1/2	FR-501	FR-502
3/4	FR-751	FR-752
1	FR-1001	FR-1002



FS Series Repair Kits

Repair kits are available for both coupler and nipple half of FS coupling. Kits include replacement elastomer seals, valve assembly and instructions to perform rebuild. Spline tool must be ordered separately to accomplish coupler half repair. Other tools required: Vise, Allen Wrench and Open End Wrench.

FS Repair Kits

TOOL Spline tool for Coupler Repair	Replacement Seals	
	No Suffix	Fluorocarbon Seals
	E5	Ethylene Propylene (EPR)
	E35	Perfluoroelastomer (Contact Factory for Seal Options).

Nipple Repair Kits

1/4	FS-252-KIT	FS-252-KIT-E5
3/8	FS-372-KIT	FS-372-KIT-E5
1/2	FS-502-KIT	FS-502-KIT-E5
3/4	FS-752-KIT	FS-752-KIT-E5
1	FS-1002-KIT	FS-1002-KIT-E5

Coupler Repair Kits

1/4	N/A	N/A
3/8	FS-371-KIT	FS-371-E5
1/2	FS-501-KIT	FS-501-KIT-E5
3/4	FS-751-KIT	FS-751-KIT-E5
1	FS-1001-KIT	FS-1001-KIT-E5

Spline Tool

N/A
FF/FS-371-TOOL
FS-501-TOOL
FF/FS-751-TOOL
FF/FS-1001-TOOL



59 Series couplings are ideal for use in high pressure, high impulse applications that require the security of a threaded connection and the ability to connect and disconnect under pressure. The robust ACME thread has a double start and allows full connection to be quickly completed in 2-1/2 turns. An internal bearing between the collar and the body keeps resistance to a minimum for an easy connection.

Features:

- Up to 6000 psi operating pressure
- Connect under residual pressure up to 5000 psi
- Disconnect under residual pressure up to 2500 psi
- Double start ACME threads provide a quick and strong connection
- High impulse resistance
- High strength materials
- Zinc nickel coating for extended durability and corrosion resistance
- Flat-face, non-spill design
- Visual and tactile confirmation when full connection is complete

Applications include:

- Mobile drill rigs
- Oil field equipment
- Umbilical lines
- High impulse mobile circuits
- Excavator attachments

59 Series Specifications

Temperature Range	Seal Material	Body Material	Valve Material	Sleeve Type	Plating
-40° to +250° F	Nitrile/Polyurethane	Steel	Stainless Steel	Thread to Connect	Zinc Nickel Plating/ FNC Coating

Performance

59 Series (1/2" & 3/4")
Test Fluid: Oil - 150 SUS

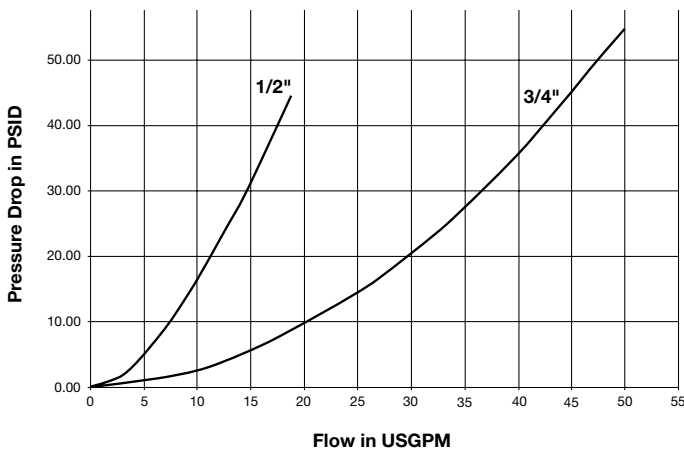

59 Series (1" & 1-1/2")
Test Fluid: Oil - 150 SUS

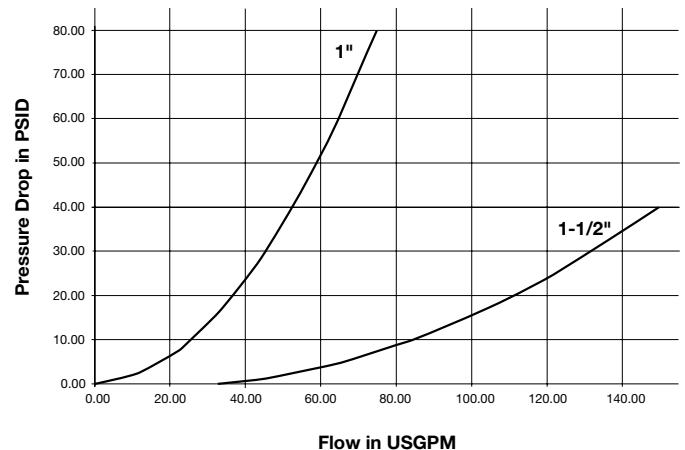



59 Series Couplers

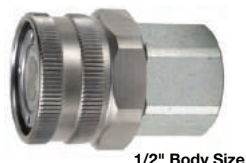

1/2" Body Size

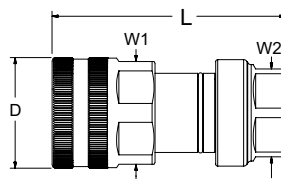

Body Size	Coupler Part Number	Port End	Length (in)	Largest Diameter (in)	Wrench Flats W1	Wrench Flats W2	Weight (lbs.)	Rated Pressure (psi)
1/2	59-501-8FP	1/2 - 14 NPSF	3.70	2.05	1-1/2"	1-7/8"	1.35	6000
1/2	59-501-8FO	3/4 - 16 UNF	3.74	2.05	1-1/2"	1-7/8"	1.37	6000
3/4	59-751-12FP	3/4 - 14 NPTF	5.53	2.49	2-3/8"	2"	3.72	6000
3/4	59-751-12FO	1 1/16 - 12 UNF	5.34	2.49	2-3/8"	2"	3.68	6000
1	59-1001-16FP	1 - 11 1/2 NPTF	5.82	2.75	65 mm	2-3/16"	4.82	6000
1	59-1001-16FO	1 5/16 - 12 UNF	5.82	2.75	65 mm	2-3/16"	4.77	6000
1-1/2	59-1501-20FP	1 1/4 - 11 1/2 NPTF	7.08	3.74	90 mm	2-5/8"	9.92	5000
1-1/2	59-1501-20FO	1 5/8 - 12 UNF	7.08	3.74	90 mm	2-5/8"	9.67	5000
1-1/2	59-1501-24FP	1 1/2 - 11 1/2 NPTF	7.08	3.74	90 mm	2-5/8"	9.92	5000
1-1/2	59-1501-24FO	1 7/8 - 12 UNF	7.08	3.74	90 mm	2-5/8"	9.67	5000

59 Series Nipples



1/2" Body Size

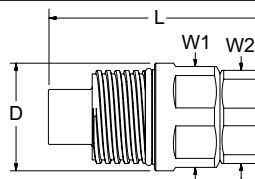

Body Size	Coupler Part Number	Port End	Length (in)	Largest Diameter (in)	Wrench Flats W1	Wrench Flats W2	Weight (lbs.)	Rated Pressure (psi)
1/2	59-502-8FP	1/2 - 14 NPSF	3.50	1.88	1-3/4"	1-1/8"	1.07	6000
1/2	59-502-8FO	3/4 - 16 UNF	3.50	1.88	1-1/2"	1-7/8"	1.07	6000
3/4	59-752-12FP	3/4 - 14 NPTF	4.65	2.31	55 mm	2"	2.81	6000
3/4	59-752-12FO	1 1/16 - 12 UNF	4.77	2.31	55 mm	2"	2.87	6000
1	59-1002-16FP	1 - 11 1/2 NPTF	5.12	2.75	65 mm	2-3/16"	4.42	6000
1	59-1002-16FO	1 5/16 - 12 UNF	5.12	2.75	65 mm	2-3/16"	4.38	6000
1-1/2	59-1502-20FP	1 1/4 - 11 1/2 NPTF	5.94	3.75	75 mm	2-5/8"	8.33	5000
1-1/2	59-1502-20FO	1 5/8 - 12 UNF	5.94	3.75	75 mm	2-5/8"	8.29	5000
1-1/2	59-1502-24FP	1 1/2 - 11 1/2 NPTF	5.94	3.75	75 mm	2-5/8"	8.33	5000
1-1/2	59-1502-24FO	1 7/8 - 12 UNF	5.94	3.75	75 mm	2-5/8"	8.29	5000

59 Series Nipple O-Ring

Body Size	Replacement External O-Ring on Nipple
1/2	4317-2-219
3/4	4317-2-224
1	4317-2-226
1 1/2	4317-2-234

59 Series Nipple Dust Cap

Image		Body Size	Nipple Dust Cap
		1/2	595DC-01
		3/4	597DC-01
		1	5910DC-01
		1 1/2	5915DC-01

59 Series Coupler Dust Plug

Image		Body Size	Coupler Dust Plug
		1/2	595DP-01
		3/4	597DP-01
		1	5910DP-01
		1 1/2	5915DP-01

WARNING: This product can expose you to chemicals including Lead, which is known to the State of California to cause cancer and birth defects or other reproductive harm. For more information go to www.P65Warnings.ca.gov



FET Series couplings are built to be used in high pressure, high impulse applications that require the security of a threaded connection and the ability to connect and disconnect under residual pressure. Interchanges with similar European style thread-to-connect couplings.

Features:

- Connect under residual pressure up to 5000 psi
- Disconnect under residual pressure up to 2500 psi
- High impulse resistance
- High strength materials
- FNC coating for extended durability and corrosion resistance
- Visual connection indicator

Applications include:

- Mobile drill rigs
- Oil field equipment
- Umbilical lines
- High impulse mobile circuits
- Excavator attachments

FET Series Specifications							
Body Size (inch)	Euro Size	Port End	Rated Pressure (psi)	Temperature Range	Body Material	Sleeve Type	Seal Material
3/8	9	Female ORB	6000	-40° to +250°F	Steel	Thread to Connect	Nitrile/ Polyurethane
		Female NPTF	6000				
1/2	13	Female ORB	6000				
		Female NPTF	6000				
5/8	15	Female ORB	6000				
		Female NPTF	6000				
3/4	17	Female ORB	6000				
		Female NPTF	6000				
		Code 62 Flange Head	6000				
		Code 62 Flange Pad	6000				
1	21	Female ORB	6000				
		Female NPTF	6000				
		Code 62 Flange Head	6000				
		Code 62 Flange Pad	6000				
1-1/2	30	Female ORB	6000				
		Female NPTF	6000				
		Code 62 Flange Head	5000				
		Code 62 Flange Pad	5000				
2	45	Female ORB	5000				
		Female NPTF	5000				



Performance

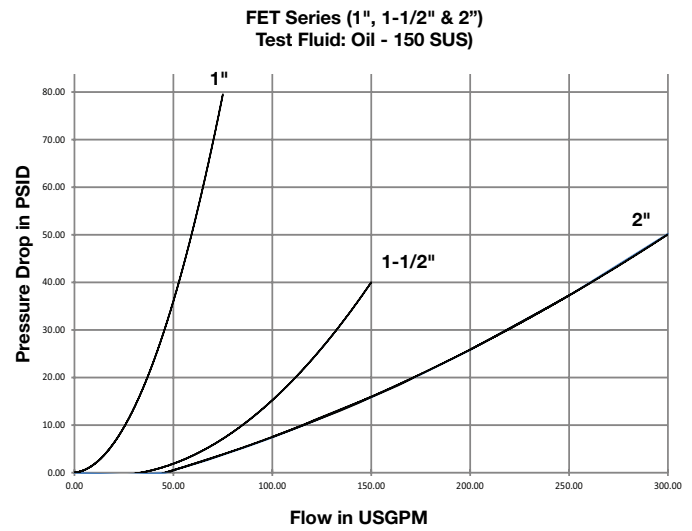
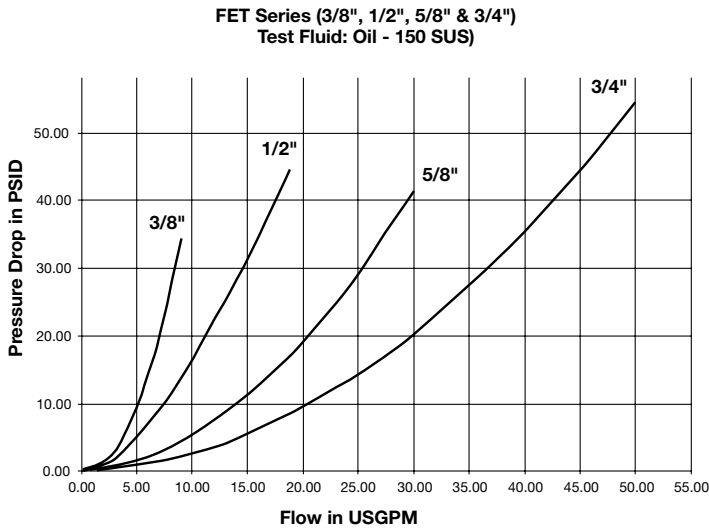

FET Series Couplers

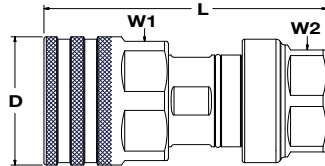

Body Size	Coupler Part Number	Port End	Length (in)	Largest Diameter (in)	Wrench Flats W1	Wrench Flats W2	Weight (lbs.)
3/8	FET-371-8FO	3/4 -16 UNF	3.83	1.65	38 mm	30 mm	0.91
3/8	FET-371-8FP	1/2 -14 NPTF	3.91	1.65	38 mm	30 mm	0.92
1/2	FET-501-10FO	7/8 -14 UNF	3.82	2.05	48 mm	1-1/2 in	1.40
1/2	FET-501-8FP	1/2 -14 NPTF	3.70	2.05	48 mm	1-1/2 in	1.38
5/8	FET-621-12FO	1 1/16 -12 UNF	4.66	2.12	50 mm	1-5/8 in	2.06
5/8	FET-621-12FP	3/4 -14 NPTF	4.52	2.12	50 mm	1-5/8 in	2.03
3/4	FET-751-16FO	1 5/16 -12 UNF	5.44	2.31	55 mm	2 in	3.30
3/4	FET-751-16FP	1 - 11 1/2 NPTF	5.44	2.31	55 mm	2 in	3.35
1	FET-1001-20FO	1 5/8 - 12 UNF	5.83	2.75	65 mm	2-3/16 in	4.72
1	FET-1001-20FP	1 1/4 -11 1/2 NPTF	5.83	2.75	65 mm	2-3/16 in	4.76
1-1/2	FET-1501-24FO	1 7/8 - 12 UNF	7.08	3.75	85 mm	2-5/8 in	10.01
1-1/2	FET-1501-24FP	1 1/2 - 11 1/2 NPTF	7.08	3.75	85 mm	2-5/8 in	10.06
2	FET-2001-32FO	2 1/2 - 12 UN	11.67	7.52	-	3-3/4	33.73
2	FET-2001-32FP	2 - 11 1/2 NPTF	11.67	7.52	-	3-3/4	34.05



WARNING: This product can expose you to chemicals including Lead, which is known to the State of California to cause cancer and birth defects or other reproductive harm. For more information go to www.P65Warnings.ca.gov

B Hydraulics



FET Series Couplers - Code 62 Flange

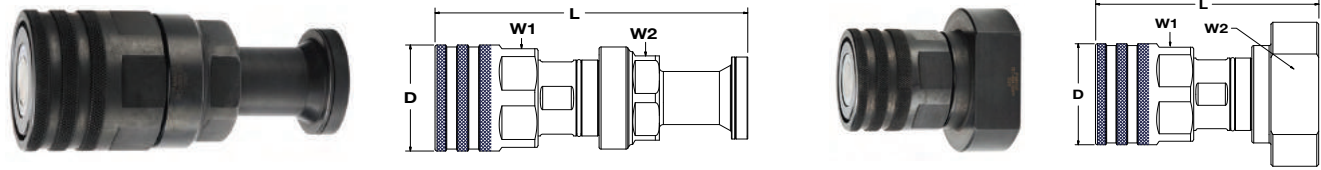

Body Size	Coupler Part Number	Port End	Bolt Thread Size	Length (in)	Largest Diameter (in)	Wrench Flats W1 (mm)	Wrench Flats W2 (in)	Weight (lbs.)
3/4	FET-751-16SF	Flange Head	-	7.60	2.31	55	2	4.17
3/4	FET-751-16SFP	Flange Pad	7/16 - 14 UNC	5.45	2.31	55	2-3/4	4.82
1	FET-1001-20SF	Flange Head	-	7.78	2.75	65	2-3/16	5.44
1	FET-1001-20SFP	Flange Pad	1/2 - 13 UNC	5.83	2.75	65	3	6.90
1-1/2	FET-1501-24SF	Flange Head	-	9.83	3.75	85	2-5/8	11.37
1-1/2	FET-1501-24SFP	Flange Pad	5/8 - 11 UNC	6.82	3.75	85	2-5/8	13.31

FET Series Nipples

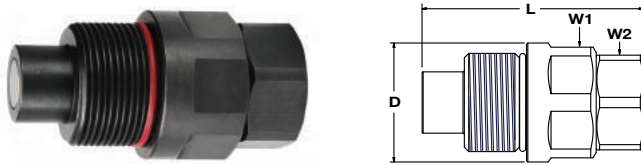

Body Size	Nipple Part Number	Port End	Length (in)	Largest Diameter (in)	Wrench Flats W1	Wrench Flats W2	Weight (lbs.)
3/8	FET-372-8FO	3/4 -16 UNF	3.51	1.60	38 mm	1-1/4 in	0.99
3/8	FET-372-8FP	1/2 -14 NPTF	3.51	1.60	38 mm	1-1/4 in	0.99
1/2	FET-502-10FO	7/8 -14 UNF	3.70	1.88	44 mm	1-1/8 in	1.14
1/2	FET-502-8FP	1/2 -14 NPTF	3.50	1.88	44 mm	1-1/8 in	1.13
5/8	FET-622-12FO	1 1/16 -12 UNF	4.21	2.12	50 mm	1-5/8 in	2.05
5/8	FET-622-12FP	3/4 -14 NPTF	4.08	2.12	50 mm	1-5/8 in	2.02
3/4	FET-752-16FO	1 5/16 -12 UNF	4.72	2.31	55 mm	2 in	2.76
3/4	FET-752-16FP	1 - 11 1/2 NPTF	4.65	2.31	55 mm	2 in	2.72
1	FET-1002-20FO	1 5/8 - 12 UNF	5.12	2.75	65 mm	2-3/16 in	4.31
1	FET-1002-20FP	1 1/4 -11 1/2 NPTF	5.12	2.75	65 mm	2-3/16 in	4.35
1-1/2	FET-1502-24FO	1 7/8 - 12 UNF	5.94	3.75	75 mm	2-5/8 in	7.94
1-1/2	FET-1502-24FP	1 1/2 -11 1/2 NPTF	5.94	3.75	75 mm	2-5/8 in	8.00
2	FET-2002-32FO	2 1/2 - 12 UN	8.56	5.70	4-1/2 in	3-3/4 in	25.51
2	FET-2002-32FP	2 -11 1/2 NPTF	8.56	5.70	4-1/2 in	3-3/4 in	25.83



WARNING: This product can expose you to chemicals including Lead, which is known to the State of California to cause cancer and birth defects or other reproductive harm. For more information go to www.P65Warnings.ca.gov



FET Series Nipples - Code 62 Flange

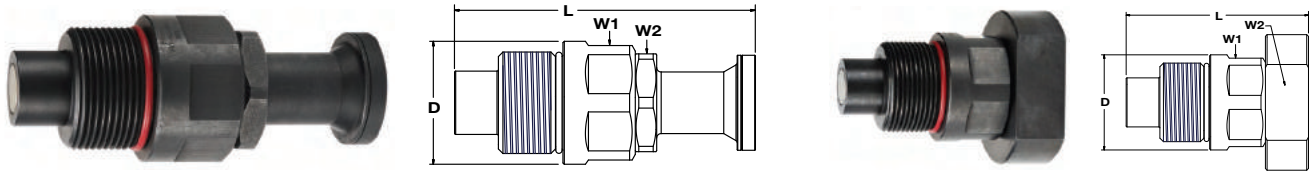

Body Size	Nipple Part Number	Port End	Bolt Thread Size	Length (in)	Largest Diameter (in)	Wrench Flats W1 (mm)	Wrench Flats W2 (in)	Weight (lbs.)
3/4	FET-752-16SF	Flange Head	-	6.32	2.31	55	2	3.10
3/4	FET-752-16SFP	Flange Pad	7/16 - 14 UNC	4.74	2.31	55	2-3/4	4.33
1	FET-1002-20SF	Flange Head	-	6.70	2.75	65	2-3/16	4.71
1	FET-1002-20SFP	Flange Pad	1/2 - 13 UNC	5.27	2.75	65	3	6.78
1-1/2	FET-1502-24SF	Flange Head	-	7.77	3.75	75	2-5/8	8.08
1-1/2	FET-1502-24SFP	Flange Pad	5/8 - 11 UNC	5.94	3.75	75	2-5/8	12.17

FET Series Dust Caps and Plugs



Body Size	Nipple Dust Cap	Coupler Dust Plug
3/8	FET3DC-01	FET3DP-01
1/2	FET5DC-01	FET5DP-01
5/8	FET6DC-01	FET6DP-01
3/4	FET7DC-01	FET7DP-01
1	FET10DC-01	FET10DP-01
1-1/2	FET15DC-01	FET15DP-01
2	FET20DC-01	FET20DP-01

FET Series Nipple Replacement O-Ring

Body Size	O-Ring Part Number	Ref Nipple P/N
3/8	50001-122-0160	FET-372
1/2	50001-219-0160	FET-502
5/8	50001-222-0160	FET-622
3/4	50001-224-0160	FET-752
1	50001-226-0160	FET-1002
1-1/2	50001-335-0160	FET-1502
2	50001-351-0160	FET-2002



WARNING: This product can expose you to chemicals including Lead, which is known to the State of California to cause cancer and birth defects or other reproductive harm. For more information go to www.P65Warnings.ca.gov

Hydraulic Quick Couplings

Connect Under Pressure

6100 Series

Threaded Connection

Flush valves, high flow

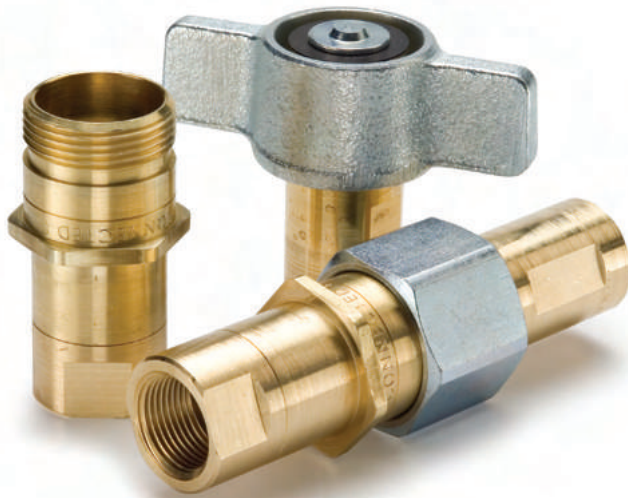

6100 Series is a thread to connect, low spill coupling that can be connected under pressure. Coupler and nipple bodies are corrosion resistant brass. Couplers are available with a steel hex nut or heavy duty wing nut sleeve. A connection indicator groove on the nipple body indicates when the connection is complete and the valves are fully open.

Features:

- Rated pressures up to 3000 psi
- Thread to connect operation
- Bonded valve seal stays in place under full pressure connect and disconnect
- Visual connection indicator
- Rugged wing nut sleeve will withstand hammering to tighten or loosen
- Optional flange for secure bulkhead mounting
- Standard end configuration is female pipe thread
- Special part numbers apply for CO2 transfer (contact QCD)

Applications:

- Submersible pumps
- Oil field equipment
- Dump trailers
- Engine test stands
- Bulk liquid transfer

Performance

6100 Series (1/2" & 3/4")
Test Fluid: OIL 150 SUS

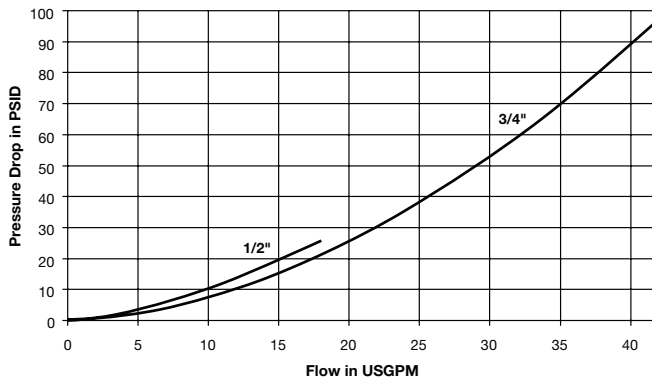

6100 Series (1", 1-1/4", 1-1/2")
Test Fluid: OIL 150 SUS

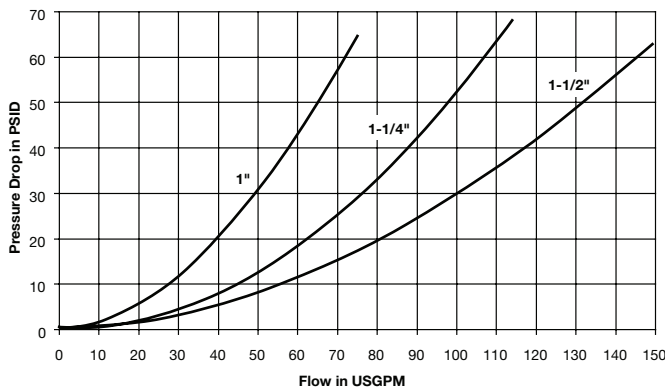

Specifications

Body Size	3/4	3/4	1	1 - 1/4	1 - 1/2
Dash Number	-08	-12	-16	-20	-24
Rated Pressure (psi) *					
Female Half	3,000	3,000	3,000	2,750	2,000
Mate Half	3,000	3,000	3,000	2,500	2,500
Complete Coupling Assembly	3,000	3,000	3,000	2,750	2,500
Rated Flow (gpm)	12	28	50	76	100
Temperature Range (std seals)	-20° to +200°F				
Seal Material**	Nitrile				

* Not recommended for continuous hydraulic impulse applications at rated pressures.

** Contact the Division for alternate seal material availability.



Coupling Set with Wingnut



Body Size	Part Number With Flange	Part Number Without Flange	Thread Size	Overall Connected Length	Weight (lbs.)
3/4	6100-08	6120-08	1/2-14 NPTF	5.20	2.12
3/4	6100-12	6120-12	3/4-14 NPTF	5.32	2.00
1	6100-16	6120-16	1-11 1/2 NPTF	5.99	3.19
1 1/4	6100-20	6120-20	1 1/4-11 1/2 NPTF	6.48	4.25
1 1/2	6100-24	6120-24	1 1/2-11 1/2 NPTF	6.80	6.13

Coupling Set with Hex Nut



Body Size	Part Number With Flange	Part Number Without Flange	Thread Size	Overall Connected Length	Weight (lbs.)
3/4	6110-08	6130-08	1/2-14 NPTF	5.20	1.89
3/4	6110-12	6130-12	3/4-14 NPTF	5.20	1.83
1	6110-16	6130-16	1-11 1/2 NPTF	5.99	2.93
1 1/4	6110-20	6130-20	1 1/4-11 1/2 NPTF	6.33	4.12
1 1/2	6110-24	6130-24	1 1/2-11 1/2 NPTF	6.55	5.95

Dust Caps for Nipples



Body Size	Dust Cap - Nipples
3/4	6108-08
1	6108-16
1 1/4	6108-20
1 1/2	6108-24

Dust Plugs for Couplers



Body Size	Dust Plug - Couplers
3/4	6109-08
1	6109-16
1 1/4	6109-20
1 1/2	6109-24



WARNING: This product can expose you to chemicals including Lead, which is known to the State of California to cause cancer and birth defects or other reproductive harm. For more information go to www.P65Warnings.ca.gov



Couplers - Wingnut



Body Size	Part Number Brass	Thread Size	Overall Length	Wrench Flats	Wing Nut	Weight (lbs.)
3/4	6125-08	1/2-14 NPTF	3.22	1.16	4.06	1.30
3/4	6125-12	3/4-14 NPTF	3.22	1.16	4.06	1.26
1	6125-16	1-11 1/2 NPTF	3.87	1.43	4.38	1.96
1 1/4	6125-20	1 1/4-11 1/2 NPTF	4.16	1.78	5.20	2.84
1 1/2	6125-24	1 1/2-11 1/2 NPTF	4.34	2.00	5.32	3.72

Couplers - Hex Nut



Body Size	Part Number Brass	Thread Size	Overall Length	Wrench Flats	Hex Size	Weight (lbs.)
3/4	6135-08	1/2-14 NPTF	3.22	1.16	1.75	1.07
3/4	6135-12	3/4-14 NPTF	3.22	1.16	1.75	1.07
1	6135-16	1-11 1/2 NPTF	3.87	1.43	2.13	1.89
1 1/4	6135-20	1 1/4-11 1/2 NPTF	4.16	1.78	2.50	2.56
1 1/2	6135-24	1 1/2-11 1/2 NPTF	4.34	2.00	2.75	3.15

Nipples



Body Size	Part Number Without Flange Brass	Part Number With Flange Brass	Thread Size	Overall Length	Wrench Flats	Hex Size	Weight (lbs.)
3/4	6105-08	6115-08	1/2-14 NPTF	3.11	1.18	1.62	0.75
3/4	6105-12	6115-12	3/4-14 NPTF	3.23	1.18	1.62	0.76
1	6105-16	6115-16	1-11 1/2 NPTF	3.55	1.56	1.88	1.30
1 1/4	6105-20	6115-20	1 1/4-11 1/2 NPTF	3.71	1.88	2.13	1.65
1 1/2	6105-24	6115-24	1 1/2-11 1/2 NPTF	4.12	2.18	2.50	2.61

Mounting Flanges



Body Size	Part Number Steel	Bolt Hole Diameter	Bolt Circle Diameter
3/4	6107-08 (1 piece)	.208	2.13
1	6107-16 (1 piece)	.208	2.38
1 1/4	6107-20 (2 piece)	.208	2.63
1 1/2	6107-24 (2 piece)	.281	3.25



WARNING: This product can expose you to chemicals including Lead, which is known to the State of California to cause cancer and birth defects or other reproductive harm. For more information go to www.P65Warnings.ca.gov



Parker's 8200 Series unique valve design allows connection while either or both the coupler and nipple are under pressure. Valves in both halves remain closed, opening only when system pressure has been relieved on the female body and then reapplied. This pressure sequence may be done with either an open center or a closed center hydraulic system that has a control valve.

Features:

- Accepts ISO 5675 universal tips
- Connect under system pressure on the coupler side and residual pressure on the nipple side
- Sleeve designed to accommodate bracket mounting
- One-handed push-to-connect operation when coupler is clamp mounted
- 1/2" body size couplers are compatible with 5001-4 and 5006-4 breakaway clamps
- Critical parts are hardened
- Protective zinc plating with clear trivalent chromate finish

Applications include:

- Tractors
- Mid-sized agricultural equipment
- Agricultural attachments requiring breakaway



8200 Series Specifications

Body Size	Rated Flow	Rated Pressure	Temperature	Body Material	Sleeve Type	Seal Material
1/2	12 gpm	3000 psi	-40° F to +250° F	Steel	Push/pull/break away	Nitrile

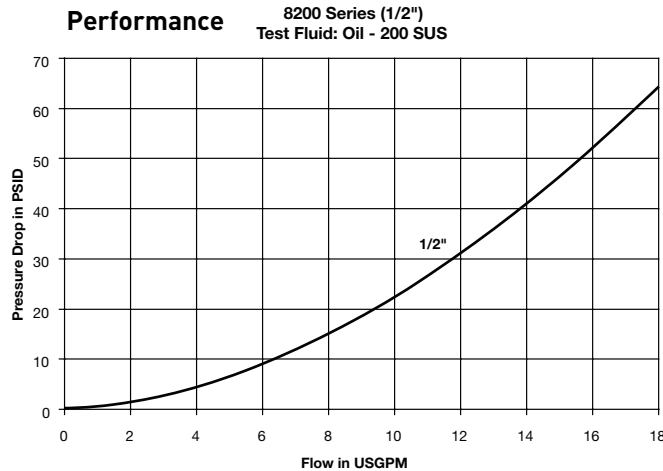

Optional Seal Materials:

(add code to part number)

Code	Description	Part Number Example
suffix W	Ethylene Propylene seal material- EPR (Couplers)	8250-15W
suffix Y	Fluorocarbon seal material (Couplers)	8250-15Y
suffix Z	Neoprene seal material (Couplers)	8250-15Z

Contact QCD for availability and additional options.
To select proper seal materials, see Fluid Compatibility Chart or contact QCD.



8200 Series Couplers - Female Thread



Body Size	Coupler Part Number	Port End	Valve Type	Length	Largest Diameter	Wrench Flats	Weight (lbs.)	Complete Coupling Part Number
1/2	8250-4	1/2-14 NPSF	Poppet	3.29	1.50	0.87	0.63	8200-4
1/2	8250-15	3/4-16 ORB	Poppet	3.29	1.50	0.87	0.63	8200-15
1/2	8250-16	7/8-14 ORB	Poppet	3.29	1.50	0.87	0.63	8200-16

8010 Series Nipples - Female Thread



Body Size	Nipple Part Number	Port End	Valve Type	Length	Largest Diameter	Wrench Flats	Weight (lbs.)	Complete Coupling Part Number
1/2	8010-4	1/2-14 NPTF	Ball	1.95	1.23	1.06	0.20	8200-4
1/2	8010-4P	1/2-14 NPTF	Poppet	1.95	1.23	1.06	0.20	-
1/2	8010-15	3/4 -16 ORB	Ball	1.95	1.23	1.06	0.20	8200-15
1/2	8010-15P	3/4 -16 ORB	Poppet	1.95	1.23	1.06	0.20	-
1/2	8010-16	7/8 -14 ORB	Ball	1.95	1.23	1.06	0.25	8200-16
1/2	8010-16P	7/8 -14 ORB	Poppet	1.95	1.23	1.06	0.25	-

8200 Series Replacement Parts

Body Size	Part Number	Description	Material
1/2	50005-211-0200	O-Ring	Nitrile

8200 Series Dust Caps and Plugs



Body Size	Dust Plug (Coupler)	Color/Material	Dust Cap (Nipple)	Weight (lbs.)
1/2	5205-4M	Black Rubber	5209-4M	.04
1/2	5005-4	Steel w/Chain	5009-4	.21
1/2	5205-4M-BU	Blue Rubber	5209-4M-BU	.04
1/2	5205-4M-GR	Green Rubber	5209-4M-GR	.04
1/2	5205-4M-RE	Red Rubber	5209-4M-RE	.04
1/2	5205-4M-YE	Yellow Rubber	5209-4M-YE	.04

 **WARNING:** This product can expose you to chemicals including Lead, which is known to the State of California to cause cancer and birth defects or other reproductive harm. For more information go to www.P65Warnings.ca.gov

Hydraulic Quick Couplings

Connect Under Pressure

9200 Series
Lever Actuated
 Accepts ISO 5675 nipples



The 9200 Series coupler allows zero pressure connection and disconnection while either or both the coupler and nipple are under pressure. A lever operated cam locks both coupler and nipple valves in the open or closed position. "Closed", the flow is shut off at the coupler, allowing easy connect and disconnect. Valves in the "Open" position are locked in place and unaffected by hydraulic surges. Valves will automatically close if the coupling is accidentally disconnected.



Features:

- Accepts ISO 5675 universal tips
- Premier connect under pressure coupling
- Locked valves prevent flow checking
- Functionally can replace a double shut-off quick coupling and two high pressure ball valves
- Protective zinc plating with clear trivalent chromate finish

Applications include:

- Mobile equipment
- Industrial hydraulics
- Not recommended for use with gaseous or compressible media

9200 Series Specifications:

Body Size	Rated Flow	Rated Pressure	Temperature	Body Material	Sleeve Type	Seal Material
1/2	12 gpm	3000 psi	-40° F to +250° F	Steel	Push/pull/breakaway	Nitrile

Performance:

9200 Series (1/2")
 Test Fluid: Oil - 200 SUS

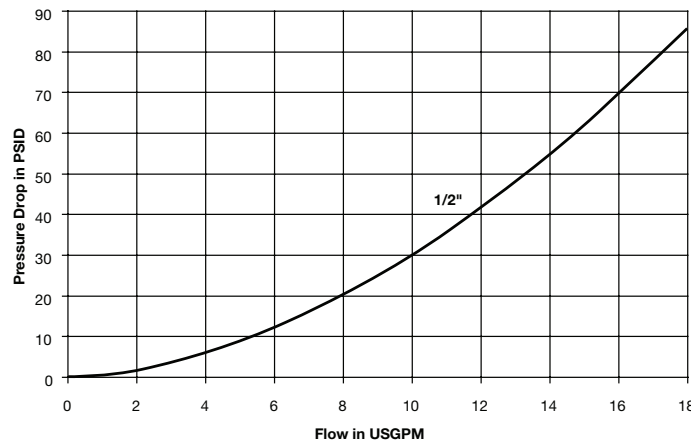

Optional Seal Materials:

[add code to part number]

Code	Description	Part Number Example
suffix W	Ethylene Propylene seal material- EPR (Couplers)	9250-4-320W
suffix Y	Fluorocarbon seal material (Couplers)	9250-4-320Y
suffix Z	Neoprene seal material (Couplers)	9250-4-320Z

Contact QCD for availability and additional options.
 To select proper seal materials, see Fluid Compatibility Chart or contact QCD.





9200 Series Couplers



Body Size	Coupler Part Number	Port End	Valve Type	Orientation	Length	Largest Diameter	Wrench Flats	Weight (lbs.)
1/2	9250-4-320*	1/2-14 NPTF	Poppet	Left hand – yellow grip	5.37	1.50	1.13	1.98
1/2	9250-6-320*	9/16-18 UNF	Poppet	Left hand – yellow grip	5.37	1.50	1.13	2.06
1/2	9250-15-320*	3/4-16 UNF	Poppet	Left hand – yellow grip	5.37	1.50	1.13	2.06
1/2	9250-16-320*	7/8-14 UNF	Poppet	Left hand – yellow grip	5.37	1.50	1.13	2.06
1/2	9250-334**	9/16-18 UNF	Poppet	Left hand – yellow grip	5.37	1.50	1.13	2.15

* -320 indicates lower sleeve spring force for easier connection when coupler is not mounted in a clamp.

** -334 couplers connect with 1/4" ISO 7241-B series nipples.

8010 Series Nipples



Body Size	Nipple Part Number	Port End	Valve Type	Length	Largest Diameter	Wrench Flats	Weight (lbs.)
1/4	H2-63-T6*	9/16-18 ORB	Poppet	1.54	1.01	0.88	0.10
1/2	8010-4	1/2-14 NPTF	Ball	1.95	1.23	1.06	0.20
1/2	8010-4P	1/2-14 NPTF	Poppet	1.95	1.23	1.06	0.20
1/2	8010-15	3/4-16 ORB	Ball	1.95	1.23	1.06	0.20
1/2	8010-15P	3/4-16 ORB	Poppet	1.95	1.23	1.06	0.20
1/2	8010-16	7/8-14 ORB	Ball	1.95	1.23	1.06	0.25
1/2	8010-16P	7/8-14 ORB	Poppet	1.95	1.23	1.06	0.25

* Connects with 9250-334 couplers

9200 Series Replacement Parts

Body Size	Part Number	Description	Weight (lbs.)
1/2	50001-211-0260	Interface O-Ring	.01

9200 Series Dust Caps and Plugs



Body Size	Coupler Dust Cover	Color/Material	Nipple Dust Cap	Weight (lbs.)
1/2	9507-4-1	Black Rubber	5209-4M	.04



WARNING: This product can expose you to chemicals including Lead, which is known to the State of California to cause cancer and birth defects or other reproductive harm. For more information go to www.P65Warnings.ca.gov

Hydraulic Quick Couplings

Connect Under Pressure

5000 Series Threaded Actuation

Accepts ISO 5675 nipples



The 5000 Series is an economical coupling that can be connected under pressure where tools can be used to make the connection. The coupler and nipple are connected and then the valves are opened from tightening the threaded union on the back of the coupler body. Unscrewing the body threads will permit the valves to close and the coupler sleeve can be retracted to release the nipple.

Features:

- Accepts ISO 5675 universal tips
- Manual, threaded actuation, connect under pressure coupling
- Protective zinc plating with clear trivalent chromate finish

Applications include:

- Lubrication systems
- Hydraulic tools
- Attachments



5000 Series Specifications

Body Size	Rated Flow	Rated Pressure	Temperature	Body Material	Sleeve Type	Seal Material
1/2	12 gpm	2500 psi	-40° F to +250° F	Steel	Single Acting	Nitrile

Performance:

5000 Series (1/2")
Test Fluid: Oil - 200 SUS

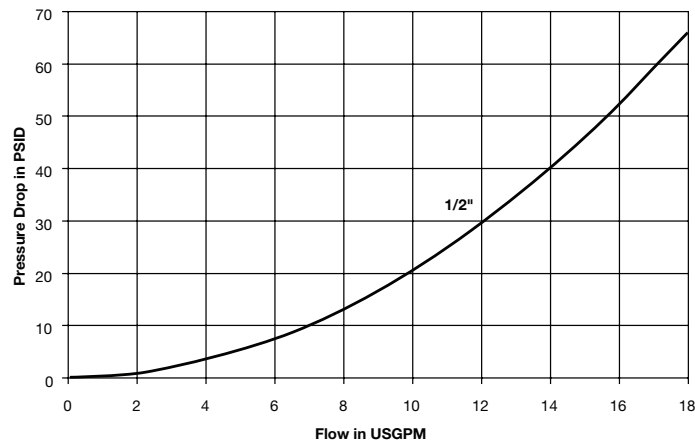



5000 Series Couplers								
Body Size	Coupler Part Number	Port End	Valve Type	Length	Largest Diameter	Wrench Flats	Weight (lbs.)	Complete Coupling Part Number
1/2	5050-4	1/2-14 NPTF	Ball	2.88	1.52	1.25	2.58	5000-4

8010 Series Nipples								
Body Size	Nipple Part Number	Port End	Valve Type	Length	Largest Diameter	Wrench Flats	Weight (lbs.)	Complete Coupling Part Number
1/2	8010-4	1/2-14 NPTF	Ball	1.95	1.23	1.06	0.20	5000-4
1/2	8010-15	3/4-16 ORB	Ball	1.95	1.23	1.06	0.20	-
1/2	8010-16	7/8-14 ORB	Ball	1.95	1.23	1.06	0.25	-

5000 Replacement Parts		1/2
O-Rings - Nitrile		50001-211-0260

5000 Series Dust Caps and Plugs				
Body Size	Dust Plug (Coupler)	Color/Material	Dust Cap (Nipple)	Weight (lbs.)
1/2	5205-4M	Black Rubber	5209-4M	.04
1/2	5205-4M-BU	Blue Rubber	5209-4M-BU	.04
1/2	5205-4M-GR	Green Rubber	5209-4M-GR	.04
1/2	5205-4M-RE	Red Rubber	5209-4M-RE	.04
1/2	5205-4M-YE	Yellow Rubber	5209-4M-YE	.04
1/2	5005-4	Steel w/Chain	5009-4	.21

Optional Seal Materials:
(add code to part number)

Code	Description	Part Number Example
suffix W	Ethylene Propylene seal material- EPR (Couplers)	5050-4W
suffix Y	Fluorocarbon seal material (Couplers)	5050-4Y
suffix Z	Neoprene seal material (Couplers)	5050-4Z

Contact QCD for availability and additional options.
To select proper seal materials, see Fluid Compatibility Chart or contact QCD.

WARNING: This product can expose you to chemicals including Lead, which is known to the State of California to cause cancer and birth defects or other reproductive harm. For more information go to www.P65Warnings.ca.gov

Hydraulic Quick Couplings

Connect Under Pressure

75 Series

Threaded Connection

Poppet valves, high pressure



The rugged 75 Series is an original Snap-tite design, constructed for high pressure hydraulic service. Although these couplings are used in a broad variety of heavy duty applications, a primary usage is in oil fields and offshore drilling. Available in sizes 3/4" through 4", in steel or stainless steel construction.

Features:

- Connect under residual pressure
- Thread-to-connect
- Up to 5,000 psi (345 bar) rated pressures
- Rugged steel construction with Zinc Trivalent Chromate plating
- Stainless steel construction also available
- Wide range of sizes
- Nitrile is standard seal material, other options available
- DBP version is "Fire Safe" rated to API 16D (limited sizes)

Applications include:

- Cranes
- Power tongs
- Horizontal boring and dewatering

75 Series Pressure Ratings

Body Size	Maximum Working Pressure (psi) Steel Only	Minimum Burst Pressure (psi) Steel Only	Maximum Working Pressure (psi) 316 Stainless (Connected Only)
3/4	5000	20000	3000
1	5000	20000	3000
1-1/4	5000	15000	3000
1-1/2	5000	15000	3000
2	5000	15000	3000
2-1/2	3000	6000	-
3	3000	6000	-
4	400	1000	-

Burst pressures listed were taken at the point at which failure rendered the quick-disconnect inoperative. (Proof pressure equals 1-1/2 times the operating pressure).

NOTE: Pressure Ratings were established under static pressure conditions.

For impulse applications, multiply the above pressure ratings by .6 for approximate pressure ratings.

-Contact QCD

75 Series Specifications

Body Size	3/4	1	1-1/4	1-1/2	2	2-1/2	3	4
Spillage (cc)	8	16	31	64	141	204	320	400
Air Inclusion (cc)	12	25	48	98	205	368	480	610

Optional Seal Materials and Features for Couplers and Nipples (add code to part number)

Code	Description	Part Number Example
suffix V	Fluorocarbon seal material	75C12-12F V
suffix E	Ethylene Propylene seal material (EPR)	75C12-12F E
suffix W	Wrench flats on body (standard on 2-1/2" and larger, no code required)	75C12-12F W
suffix DBP	"Fire Safe" BOP version (limited sizes, no alternate seal options)	SB-75C12-12F- DBP

Contact QCD for availability and additional options.

To select proper seal materials, see Fluid Compatibility Chart or contact QCD.





Performance

Torque Values for Connecting Under Pressure

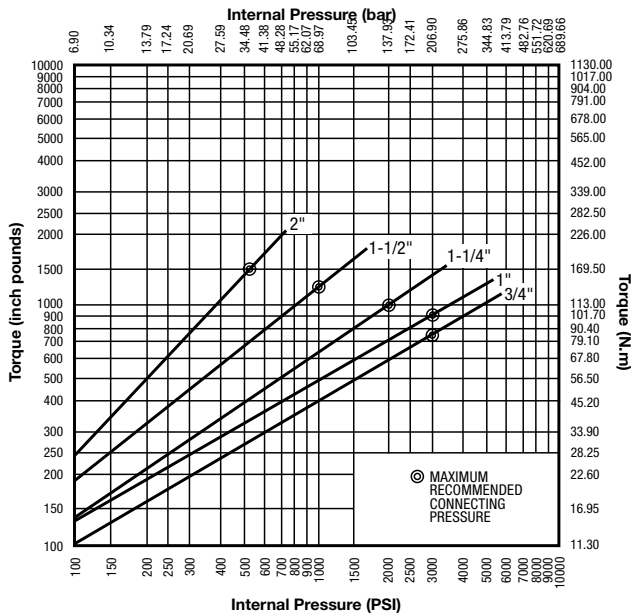

Flow Chart

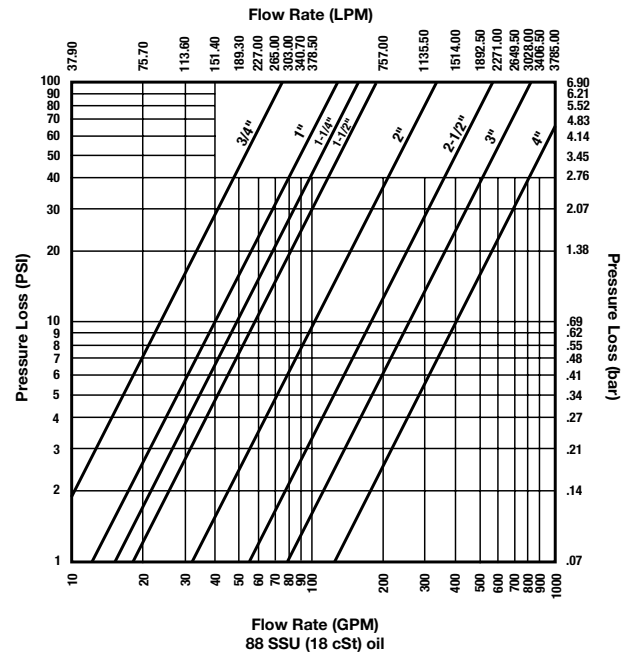

Ordering Guide

75 C 12 - 12 F

Options:
DBP*** = "Fire Safe" BOP version 3/4" thru 2" steel, 1" and 1-1/4" stainless steel

Options:
W** = Wrench Flats on body

Seals:
Blank = Nitrile
V = Fluorocarbon
E = Ethylene Propylene Rubber

End Fitting Type:
F* = Female Pipe NPTF for Steel - NPT for 316 SST
EF = Female SAE
RP = Female British Parallel BS2779

End Fitting Size:
12 = 3/4" 32 = 2"
16 = 1" 40 = 2-1/2"
20 = 1-1/4" 48 = 3"
24 = 1-1/2" 64 = 4"

Coupling Body Size:
12 = 3/4" 32 = 2"
16 = 1" 40 = 2-1/2"
20 = 1-1/4" 48 = 3"
24 = 1-1/2" 64 = 4"

Coupling Half:
C = Coupler
N = Nipple

Series:
75

Material:
Blank = Steel plated
S = 316 Stainless Steel

*For sizes up to 3", NPTF threads. For sizes over 3", NPT threads.
**Not available on 2" EF coupler. Standard on 2-1/2" and larger sizes (code not needed).
***DBP available in 3/4" through 2" sizes steel material, 1" and 1-1/4" stainless steel.
*Seal material code not applicable with DBP option-leave blank.

Note: Not all configurations are standard product offering. Contact QCD for price and delivery.

75 Series Dust Caps and Plugs



Body Size	Dust Plug (Coupler)	Dust Cap (Nipple)
3/4	75MDP-12	75MDC-12
1	75MDP-16	75MDC-16
1-1/4	75MDP-20	75MDC-20
1-1/2	75MDP-24	75MDC-24
2	75MDP-32	75MDC-32
2-1/2	75MDP-40	75MDC-40
4	75MDP-64	75MDC-64

75 Series Repair Kits

Body Size	Coupler Kit	Nipple Kit
3/4	75C12-SPK	75N12-SPK
1	75C16-SPK	75N16-SPK
1-1/4	75C20-SPK	75N20-SPK
1-1/2	75C24-SPK	75N24-SPK
2	75C32-SPK	75N32-SPK
2-1/2	75C40-SPK	75N40-SPK
4	75C64-SPK	75N64-SPK

Each kit contains a valve assembly, spring and guide stop. Consult QCD for "DBP" option seals.



75 Series Couplers



Body Size	Part Number Steel	Port End	Part Number 316 Stainless Steel	Port End	Length (in)	Largest Diameter	Wrench Flats
3/4	75C12-12F	3/4-14 NPSF	S75C12-12F	3/4-14 NPSF	2.84	2.06	1.31
3/4	75C12-12F-DBP	3/4-14 NPSF	-	-	2.84	2.06	N/A
1	75C16-16F	1-11-1/2 NPSF	S75C16-16F	1-11-1/2 NPSF	3.45	4.25	1.69
1	75C16-16F-DBP	1-11-1/2 NPSF	S75C16-16F-DBP	1-11-1/2 NPSF	3.45	4.25	N/A
1-1/4	75C20-20F	1-1/4-11-1/2 NPTF	S75C20-20F	1-1/4-11-1/2 NPT	4.40	4.75	2.00
1-1/4	75C20-20F-DBP	1-1/4-11-1/2 NPTF	S75C20-20F-DBP	1-1/4-11-1/2 NPT	4.40	4.75	N/A
1-1/2	75C24-24F	1-1/2-11-1/2 NPTF	S75C24-24F	1-1/2-11-1/2 NPT	5.04	5.75	2.25
1-1/2	75C24-24F-DBP	1-1/2-11-1/2 NPTF	-	-	5.04	5.75	N/A
2	75C32-32F	2-11-1/2 NPT	S75C32-32F	2-11-1/2 NPT	6.07	6.75	3.00
2	75C32-32F-DBP	2-11-1/2 NPT	-	-	6.07	6.75	3.00
2-1/2	75C40-40F	2-1/2-8 NPTF	S75C40-40F	2-1/2-8 NPTF	5.29	8.00	3.50
3	75C48-48F	3-8 NPTF	S75C48-48F	3-8 NPTF	5.84	8.50	4.25

75 Series Nipples



Body Size	Part Number Steel	Port End	Part Number 316 Stainless Steel	Port End	Length (in)	Largest Diameter	Wrench Flats
3/4	75N12-12F	3/4-14 NPSF	S75N12-12F	3/4-14 NPSF	3.27	1.75	1.56
3/4	75N12-12F-DBP	3/4-14 NPSF	-	-	3.27	1.75	N/A
1	75N16-16F	1-11-1/2 NPSF	S75N16-16F	1-11-1/2 NPSF	4.17	2.25	2.00
1	75N16-16F-DBP	1-11-1/2 NPSF	S75N16-16F-DBP	1-11-1/2 NPSF	4.17	2.25	N/A
1-1/4	75N20-20F	1-1/4-11-1/2 NPTF	S75N20-20F	1-1/4-11-1/2 NPT	5.36	2.62	2.38
1-1/4	75N20-20F-DBP	1-1/4-11-1/2 NPTF	S75N20-20F-DBP	1-1/4-11-1/2 NPT	5.36	2.62	N/A
1-1/2	75N24-24F	1-1/2-11-1/2 NPTF	S75N24-24F	1-1/2-11-1/2 NPT	5.97	3.25	2.88
1-1/2	75N24-24F-DBP	1-1/2-11-1/2 NPTF	-	-	5.97	3.25	N/A
2	75N32-32F	2-11-1/2 NPT	S75N32-32F	2-11-1/2 NPT	7.05	4.00	3.50
2	75N32-32F-DBP	2-11-1/2 NPT	-	-	7.05	4.00	N/A
2-1/2	75N40-40F	2-1/2-8 NPTF	S75N40-40F	2-1/2-8 NPTF	7.46	5.00	3.50
3	75N48-48F	3-8 NPTF	S75N48-48F	3-8 NPTF	8.26	6.00	4.25

Contact QCD for additional sizes and end configurations.



WARNING: This product can expose you to chemicals including Lead, which is known to the State of California to cause cancer and birth defects or other reproductive harm. For more information go to www.P65Warnings.ca.gov



Parker's 71 Series, formerly Snap-tite couplings are designed for working pressures up to 10,000 psi. Available in a variety of materials and with a wide range of body sizes. Air inclusion and fluid loss are minimal with the flush face valves. Large flow chambers in the body and an exclusive valve design permit superior flow while maintaining low pressure drop.



Features:

- Flush face/Non-spill
- Push-to-connect
- Heavy duty construction
- Designed for up to 10,000 psi (690 bar) working pressures
- Variety of materials
- Wide range of sizes
- Superior flow and low pressure drop
- Sleeve lock option to protect against accidental disconnection.

Applications include:

- Industrial hydraulic lines
- Off-shore drilling

71 Series Pressure Ratings						
Body Size	Steel		316 Stainless Steel		High Pressure Stainless Steel	
	Maximum Working (psi)	Minimum Burst* (psi)	Maximum Working (psi)	Minimum Burst* (psi)	Maximum Working (psi)	Minimum Burst* (psi)
1/4	10,000	20,000	5,000	12,500	10,000	20,000
3/8 x 1/4 ¹	10,000	20,000	5,000	12,500	10,000	20,000
3/8	10,000	20,000	5,000	12,500	10,000	20,000
3/8 x 1/2 ²	10,000	20,000	5,000	12,500	10,000	20,000
1/2	10,000	20,000	5,000	12,500	10,000	20,000
3/4	7,500	15,000	5,000	12,500	7,500	15,000
1	7,500	15,000	4,000	10,000	7,500	15,000
1 x 1-1/4 ³	7,500	15,000	4,000	10,000	7,500	15,000
2 x 1-1/2 ⁴	5,000	10,000	3,000	6,000	5,000	10,000
2	5,000	10,000	3,000	6,000	5,000	10,000

¹Unit is 3/8" with 1/4" end fitting. ²Unit is 3/8" with 1/2" end fitting, ³1" unit with 1-1/4" end fitting, and ⁴2" unit with 1-1/2" end fitting.
***NOTE:** Pressure Ratings were established under static pressure conditions. For high impulse applications, consult QCD.

Specifications										
Body Size	1/4	3/8 x 1/4 ¹	3/8	3/8 x 1/2 ²	1/2	3/4	1	1 x 1-1/4 ³	2 x 1-1/4 ⁴	2
Spillage (cc)	.02	.02	.02	.02	.03	.06	.10	.10	5.25	5.25
Air Inclusion (cc)	.01	.02	.02	.02	.03	.04	.06	.06	30.50	30.50

Maximum Recommended Connect/Disconnect Pressures				
Body Size	1/4	3/8, 1/2, 3/4	1, 1-1/4	1-1/2, 2
Pressure	300	150	75	0



Performance

Sizes 1/4 thru 1-1/4

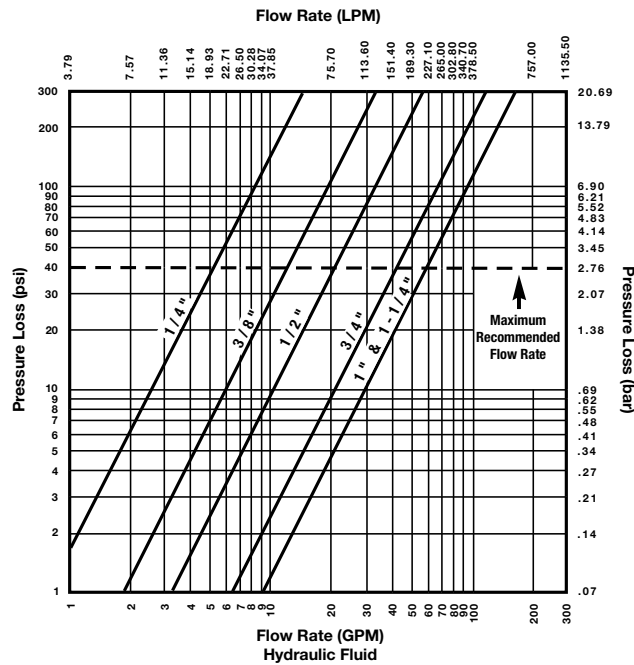

Sizes 1-1/2 and 2

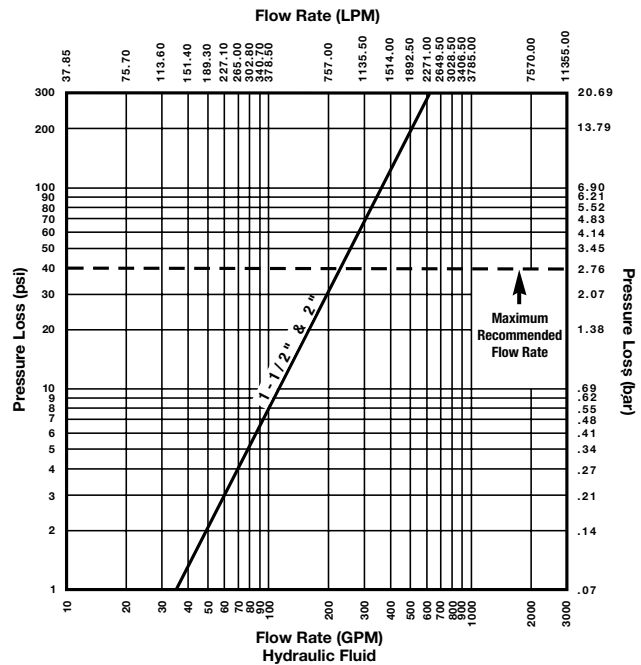

Gallons per minute (gpm) in US gallons. Test Media MIL-H-6083 Hydraulic Fluid at 90°F ± 5°F (+32°C ± 1.5°C) sg .83

Ordering Guide

71-3 C 4 - 4 F

- Series:**
 - 71 = 1-1/2" & 2" Nipples Only
 - 71-1 = 1-1/2" & 2" Couplers Only
 - 71-3 = 1/4" thru 1-1/4" Both
- Coupling Half:**
 - C = Coupler
 - N = Nipple
- Coupling Body Size:**
 - 4 = 1/4" 12 = 3/4"
 - 6 = 3/8" 16 = 1"
 - 8 = 1/2" 24 = 1-1/2"
 - 12 = 3/4" 32 = 2"
- End Fitting Size:**
 - 4 = 1/4" 16 = 1"
 - 6 = 3/8" 20 = 1-1/4"
 - 8 = 1/2" 24 = 1-1/2"
 - 12 = 3/4" 32 = 2"
- End Fitting Type:**
 - F* = Female NPTF
 - EF = Female SAE
 - RP = Female British Parallel BS2779
 - Autoclave cone & threaded fittings available (consult QCD)
- Seals:**
 - Standard Seal = Nitrile
 - V = Fluorocarbon
 - E = Ethylene Propylene
 - M = MHO
- Options:**
 - SL = Sleeve Lock
- Material:**
 - Blank = Steel, zinc trivalent plating
 - S = 316 Stainless Steel
 - SH = High Pressure Stainless Steel

* For sizes up to 1" NPTF threads in steel.
 For sizes up to 1" NPSF threads in stainless steel.
 For sizes over 1" NPT threads.



71 Series Couplers



Body Size	Part Number Steel	Port End	Part Number 316 Stainless Steel	Part Number High Pressure Stainless Steel	Port End	Length (in)	Largest Dia.	Wrench Flats
1/4	71-3C4-4F	1/4 - 18 NPTF	S71-3C4-4F	SH71-3C4-4F	1/4 - 18 NPTF	1.96	1.19	0.94
1/4	71-3C4-4EF	7/16 - 20 UNF	S71-3C4-4EF	-	7/16 - 20 UNF	1.96	1.19	0.94
3/8	71-3C6-4F	1/4 - 18 NPTF	-	-	-	2.36	1.56	1.19
3/8	71-3C6-6F	3/8 - 18 NPTF	S71-3C6-6F	SH71-3C6-6F	3/8 - 18 NPSF	2.36	1.56	1.19
3/8	71-3C6-6EF	9/16 - 18 UNF	S71-3C6-6EF	SH71-3C6-6EF	9/16 - 18 UNF	2.36	1.56	1.19
3/8	71-3C6-8F	1/2 - 14 NPTF	S71-3C6-8F	-	1/2 - 14 NPSF	2.57	1.56	1.19
1/2	71-3C8-8F	1/2 - 14 NPTF	S71-3C8-8F	SH71-3C8-8F	1/2 - 14 NPSF	2.77	1.88	1.50
1/2	71-3C8-8EF	3/4 - 16 UNF	S71-3C8-8EF	-	3/4 - 16 UNF	2.77	1.88	1.50
3/4	71-3C12-12F	3/4 - 14 NPTF	S71-3C12-12F	SH71-3C12-12F	3/4 - 14 NPSF	3.05	2.25	1.75
3/4	71-3C12-12EF	1-1/16 - 12 UNF	S71-3C12-12EF	-	1-1/16 - 12 UNF	3.05	2.25	1.75
1	71-3C16-16F	1 - 11-1/2 NPTF	S71-3C16-16F	SH71-3C16-16F	1 - 11-1/2 NPSF	3.32	2.63	2.00
1	71-3C16-16EF	1-5/16 - 12 UNF	S71-3C16-16EF	-	1-5/16 - 12 UNF	3.32	2.63	2.00
1	71-3C16-20F	1-1/4 - 11-1/2 NPT	S71-3C16-20F	-	1-1/4 - 11-1/2 NPT	3.32	2.63	2.00
1	71-3C16-20EF	1-5/8 - 12 UNF	S71-3C16-20EF	-	1-5/8 - 12 UNF	3.32	2.63	2.00
2	71-1C32-24F	1-1/2 - 11-1/2 NPT	-	-	-	6.21	4.50	3.38
2	71-1C32-24EF	1-7/8 - 12 UNF	-	-	-	6.21	4.50	3.38
2	71-1C32-32F	2 - 11-1/2 NPT	-	-	-	6.21	4.50	3.38
2	71-1C32-32EF	2-1/2 - 12 UNF	-	-	-	6.21	4.50	3.38

NOTE:

1. The 71-3 style couplers and nipples are interchangeable with the previous design couplers and nipples in sizes 3/8", 1/2" and 3/4".
2. Old style 1" couplers and nipples (71-2C16 and 71-2N16) are not interchangeable with the 71-3 design. Contact QCD for information.
3. Internal components of S71 and SH71 couplers and nipples are not all 316 stainless steel. Contact QCD for details.
4. Prop 65 Warning does not apply to stainless steel part numbers.

71 Series Dust Caps



Body Size	Dust Cap (Coupler)	Dust Cap (Nipple)
1/4	71-3PCC-4	71-3PNC-4
3/8	71-3PCC-6	71-3PNC-6
1/2	71-3PCC-8	71-3PNC-8
3/4	71-3PCC-12	71-3PNC-12
1	71-3PCC-16	71-3PNC-16

WARNING: This product can expose you to chemicals including Lead, which is known to the State of California to cause cancer and birth defects or other reproductive harm. For more information go to www.P65Warnings.ca.gov



71 Series Nipples



Body Size	Part Number Steel	Port End	Part Number 316 Stainless Steel	Part Number High Pressure Stainless Steel	Port End	Length (in)	Largest Dia.	Wrench Flats
1/4	71-3N4-4F	1/4 - 18 NPTF	S71-3N4-4F	SH71-3N4-4F	1/4 - 18 NPTF	1.84	0.89	0.81
1/4	71-3N4-4EF	7/16 - 20 UNF	S71-3N4-4EF	-	7/16 - 20 UNF	1.84	0.89	0.81
3/8	71-3N6-4F	1/4 - 18 NPTF	-	-	-	1.84	1.18	1.00
3/8	71-3N6-6F	3/8 - 18 NPTF	S71-3N6-6F	SH71-3N6-6F	3/8 - 18 NPSF	2.32	1.18	1.00
3/8	71-3N6-6EF	9/16 - 18 UNF	S71-3N6-6EF	SH71-3N6-6EF	9/16 - 18 UNF	2.32	1.18	1.00
3/8	71-3N6-8F	1/2 - 14 NPTF	-	-	-	2.57	1.65	1.25
1/2	71-3N8-8F	1/2 - 14 NPTF	S71-3N8-8F	SH71-3N8-8F	1/2 - 14 NPSF	2.38	1.65	1.50
1/2	71-3N8-8EF	3/4 - 16 UNF	S71-3N8-8EF	SH71-3N8-8EF	3/4 - 16 UNF	2.38	1.65	1.50
3/4	71-3N12-12F	3/4 - 14 NPTF	S71-3N12-12F	SH71-3N12-12F	3/4 - 14 NPSF	2.96	1.92	1.75
3/4	71-3N12-12EF	1-1/16 - 12 UNF	S71-3N12-12EF	-	1-1/16 - 12 UNF	2.96	1.92	1.75
1	71-3N16-16F	1 - 11-1/2 NPTF	S71-3N16-16F	SH71-3N16-16F	1 - 11-1/2 NPSF	3.23	2.09	1.88
1	71-3N16-16EF	1-5/16 - 12 UNF	S71-3N16-16EF	-	1-5/16 - 12 UNF	3.23	2.09	1.88
1	71-3N16-20F	1-1/4 - 11-1/2 NPT	S71-3N16-20F	-	1-1/4 - 11-1/2 NPT	3.23	2.20	1.88
1	71-3N16-20EF	1-5/8 - 12 UNF	S71-3N16-20EF	-	1-5/8 - 12 UNF	3.23	2.20	1.88
2	71N32-24F	1-1/2 - 11-1/2 NPT	-	-	-	4.50	3.50	3.25
2	71N32-24EF	1-7/8 - 12 UNF	-	-	-	4.50	3.50	3.25
2	71N32-32F	2 - 11-1/2 NPT	-	-	-	4.50	3.50	3.25

NOTE:

1. The 71-3 style couplers and nipples are interchangeable with the previous design couplers and nipples in sizes 3/8", 1/2" and 3/4".
2. Old style 1" couplers and nipples (71-2C16 and 71-2N16) are not interchangeable with the 71-3 design. Contact QCD for information.
3. Internal components of S71 and SH71 couplers and nipples are not all 316 stainless steel. Contact QCD for details.
4. Prop 65 Warning does not apply to stainless steel part numbers.



WARNING: This product can expose you to chemicals including Lead, which is known to the State of California to cause cancer and birth defects or other reproductive harm. For more information go to www.P65Warnings.ca.gov



The 3000 Series coupling are designed for high pressure applications. The coupler sleeve and nipple body must be manually threaded together to make the connection.

Features:

- Manual threaded connection and actuation
- Hard, chrome alloy ball valves
- Polyurethane interface seal resists high pressure extrusion
- Threaded retainer provides a positive valve stop
- Protective zinc plating with clear trivalent chromate finish

Applications include:

- Hydraulic rams
- Portable hydraulic tools
- Crimping equipment

3000 Series Specifications						
Body Size	Rated Flow (gpm)	Rated Pressure (psi)	Temperature	Body Material	Sleeve Type	Seal Material
1/4	3	10,000	-22° F to +230° F	Steel	Thread to connect	Polyurethane
3/8	6			Steel	Thread to connect	Polyurethane

Performance:

3000 Series (1/4", 3/8")
Test Fluid: Oil - 200 SUS

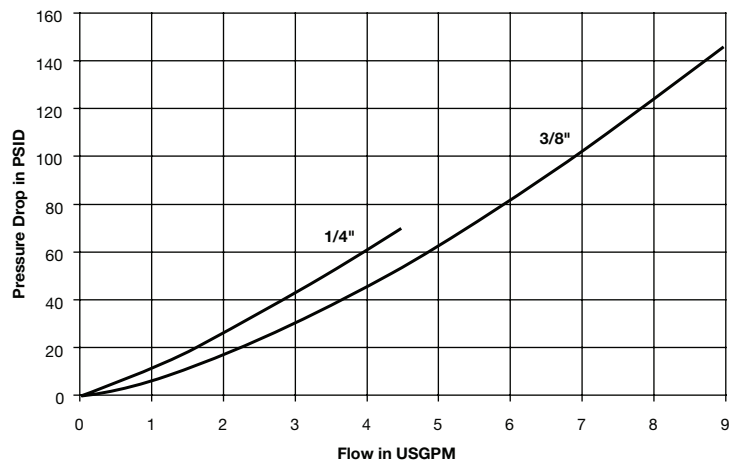



3000 Series Couplers



Body Size	Coupler Part Number	Port End	Valve Type	Length	Largest Diameter	Wrench Flats	Weight (lbs.)
1/4	3050-2	1/4-18 NPTF (Male)	Ball	2.38	1.13	0.81	0.25
3/8	3050-3	3/8-18 NPTF (Male)	Ball	2.38	1.38	1.00	0.49
3/8	3050-3-231	3/8-18 NPTF (Female)	Ball	2.38	1.38	1.00	0.49

3000 Series Nipples



Body Size	Nipple Part Number	Port End	Valve Type	Length	Largest Diameter	Wrench Flats	Weight (lbs.)
1/4	3010-2	1/4-18 NPTF (Female)	Ball	1.29	1.13	0.88	0.14
3/8	3010-3	3/8-18 NPTF (Female)	Ball	1.58	1.25	0.94	0.23
3/8	3010-3-230	3/8-18 NPTF (Male)	Ball	2.31	1.25	1.00	0.30

3000 Series Replacement O-Rings

Body Size	Material	Part Number	Durometer
1/4	Polyurethane	50001-114-0296	90
3/8	Polyurethane	50001-210-0296	90

3000 Series Dust Caps and Plugs



Body Size	Dust Cap (Nipple)	Color/Material	Dust Plug (Coupler)	Weight (lbs.)
1/4	3009-2	Steel	3005-2	.02
3/8	3009-3	Steel	3005-3	.04



WARNING: This product can expose you to chemicals including Lead, which is known to the State of California to cause cancer and birth defects or other reproductive harm. For more information go to www.P65Warnings.ca.gov

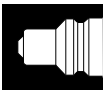

TC Series couplings are used in high pressure applications with hydraulic and mechanical shock. Steel coupler sleeves and nipple bodies are hardened for resistance to damage. Fluorocarbon seals along with PTFE back up rings provide reliable sealing in high pressures. Available in 3/8 inch size only, with sleeve lock to guard against accidental disconnection.

Features:

- Rated pressure up to 10,000 psi
- Manual sleeve operation
- Fluorocarbon seals
- Standard sleeve lock guards against accidental disconnection
- Positive valve stop prevents flow checking
- Standard end configuration is female pipe thread
- Protective zinc plating with clear trivalent chromate finish

Applications:

- Hydraulic jacking and house moving equipment
- Construction equipment
- Railway maintenance

Performance

TC Series (3/8")
Test Fluid: Oil - 200 SUS

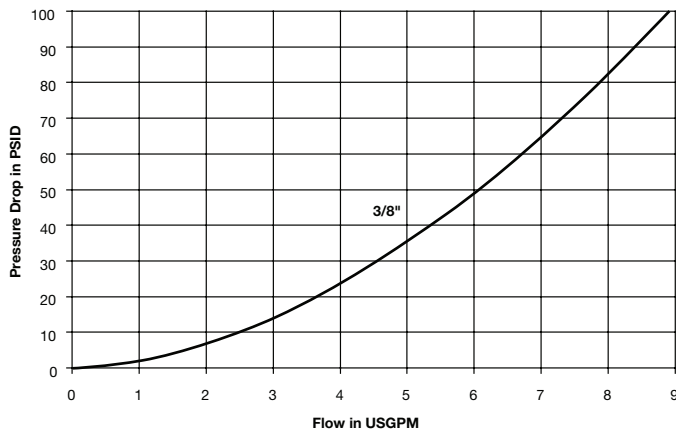

Specifications

Body Size	3/8
Rated Pressure (psi)	10,000
Rated Flow (gpm)	6
Temperature Range (std seals)	-15° to +400° F

TC Series Dust Plug/Caps

TR-37

Coupler



Body Size	Part Number	Thread Size	Overall Length	Largest Diameter	Wrench Flats	Weight (lbs.)
3/8	TC-371	3/8-18 NPSF	2.48	1.25	0.94	0.43

Nipple



Body Size	Part Number	Thread Size	Overall Length	Exposed Length	Largest Diameter	Wrench Flats	Weight (lbs.)
3/8	TC-372	3/8-18 NPSF	1.82	0.66	1.08	0.94	0.14



WARNING: This product can expose you to chemicals including Lead, which is known to the State of California to cause cancer and birth defects or other reproductive harm. For more information go to www.P65Warnings.ca.gov



1141 Series are general purpose couplings that connect under pressure for high pressure applications. The 1/4 inch stainless steel coupling connects together with a threaded brass sleeve. Polyurethane seals resist extrusion and abrasion.

Features:

- 303 stainless steel body
- Rated pressure up to 10,000 psi and 17,000 psi intermittent pressure
- Small diameter mating seal keeps separation forces to a minimum, allowing easier threaded connection and disconnection at pressures up to 5,000 psi
- Polyurethane seals to resist extrusion and abrasion
- Self locking threads guard against accidental disconnection
- Visual connection indicator – when fully coupled, sleeve edge is flush with the end of the male thread
- Standard end configuration is female pipe thread
- Dust caps and plugs included

Applications:

- Off shore equipment
- Hydraulic lines in corrosive environments

Specifications

Body Size	1/4
Rated Pressure (psi)	10,000
Rated Connect-Under-Pressure Capability (psi)	5,000
Rated Flow (gpm)	3
Temperature Range (Polyurethane seals)	-30° to +180° F
Vacuum Test	20 in/Hg
Torque to connect at 1000 psi	47 in/lbs.

Coupler



Body Size	Part Number	Thread Size	Length	Sleeve Hex	Wrench Flat	Weight (lbs.)
1/4	1141-62	1/4-18 NPTF	2.75	1.00	0.88	0.40

Nipple



Body Size	Part Number	Thread Size	Length	Wrench Flat	Weight (lbs.)
1/4	1141-63	1/4-18 NPTF	2.00	0.88	0.26



WARNING: This product can expose you to chemicals including Lead, which is known to the State of California to cause cancer and birth defects or other reproductive harm. For more information go to www.P65Warnings.ca.gov



ST Series non-valved couplings provide maximum flow and low pressure drop. The smooth, open bore allows easy cleaning in applications where the same lines are used for more than one media.

Features

- Steel nipples are case hardened for resistance to Brinelling
- Functionally interchanges with similar straight-through design couplings
- Standard Nitrile seals
- Material options available
- Sleeve-Lok option available

Applications:

- High pressure water
- Steam washers
- Carpet cleaners

Specifications					
Body Size	Rated Pressure (psi) Brass Coupler/Nipple	Rated Pressure (psi) Brass Coupler/Steel Nipple	Rated Pressure (psi) 303 SS Coupler/Nipple	Temperature Range (standard seals)	Rated Flow
1/8	2500	2600	4200	-40° to +250° F	3
1/4	5200	5500	6700		6
3/8	2700	3500	5500		12
1/2	2200	2700	3000		12
3/4	1700	2700	3000		28
1	1200	2000	1700		50
1-1/4	1700	-	-		76
1-1/2	1400	-	-		100

Performance

ST Series (1/8", 1/4", 3/8", 1/2")
Test Fluid: Oil - 150 SUS

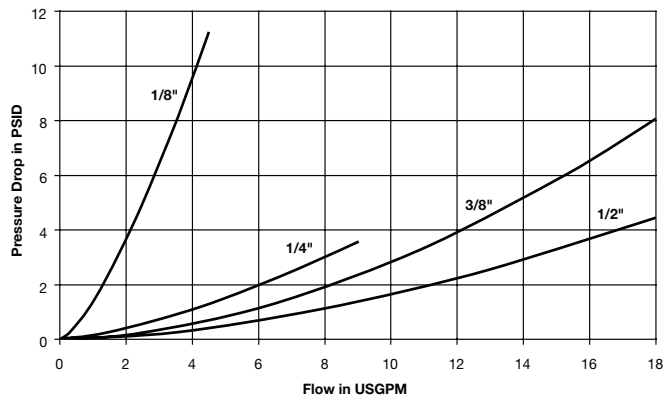

ST Series (3/4", 1", 1-1/4")
Test Fluid: Oil - 150 SUS

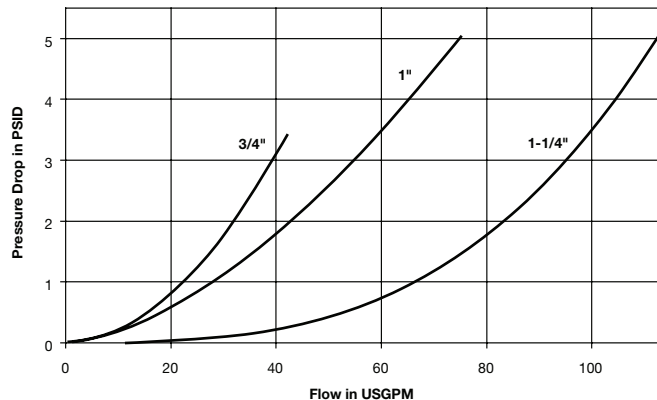



ST Series Couplers - Female Pipe Thread



Body Size	Brass Part Number	303 Stainless Part Number*	Port End	Length	Largest Diameter	Wrench Flats	Brass Weight (lbs.)	Stainless Weight (lbs.)
1/8	BST-1	SST-1	1/8-27 NPTF	1.06	0.69	0.56	0.06	0.05
1/4	BST-2	SST-2	1/4-18 NPTF	1.54	0.94	0.81	0.17	0.15
3/8	BST-3	SST-3	3/8-18 NPTF	1.64	1.16	1.00	0.26	0.24
1/2	BST-4	SST-4	1/2-14 NPTF	1.98	1.30	1.13	0.40	0.37
3/4	BST-6	SST-6	3/4-14 NPTF	2.15	1.66	1.44	0.62	0.57
1	BST-8	SST-8	1-11 1/2 NPTF	2.43	2.02	1.75	0.99	0.93
1-1/4	BST-10**	-	1 1/4-11 1/2 NPTF	2.44	2.51	2.00	1.38	-
1-1/2	BST-12**	-	1 1/2-11 1/2 NPTF	2.88	3.00	2.50	2.43	-

** Steel sleeves

ST Series Couplers - Male Pipe Thread



Body Size	Brass Part Number	303 Stainless Part Number*	Port End	Length	Largest Diameter	Wrench Flats	Brass Weight (lbs.)	Stainless Weight (lbs.)
1/8	BST-1M	SST-1M	1/8-27 NPTF	1.06	0.69	0.56	0.05	0.05
1/4	BST-2M	SST-2M	1/4-18 NPTF	1.69	0.94	0.81	0.13	0.16
3/8	BST-3M	SST-3M	3/8-18 NPTF	1.75	1.16	1.00	0.25	1.16
1/2	BST-4M	SST-4M	1/2-14 NPTF	1.94	1.30	1.13	0.34	1.30
3/4	BST-6M	SST-6M	3/4-14 NPTF	2.17	1.66	1.44	-	1.66
1	BST-8M	SST-8M	1-11 1/2 NPTF	2.53	2.02	1.75	0.85	2.02

* Prop 65 Warning does not apply to stainless steel part numbers

Optional Materials and Features:

(add code to part number)

Code	Description	Part Number Example
suffix -SL	Sleeve-Lok (Couplers)	SST-3M-SL
suffix W	Ethylene Propylene seal material- EPR (Couplers)	SST-3MW
suffix Y	Fluorocarbon seal material (Couplers)	SST-3MY
suffix Z	Neoprene seal material (Couplers)	SST-3MZ

Contact QCD for availability and additional options.

To select proper seal materials, see Fluid Compatibility Chart or contact QCD.



WARNING: This product can expose you to chemicals including Lead, which is known to the State of California to cause cancer and birth defects or other reproductive harm. For more information go to www.P65Warnings.ca.gov



ST Series Nipples- Female Pipe Thread



Body Size	Brass Part No.	Weight. (lbs.)	Steel Part No.	Weight. (lbs.)	303 Stainless Part No.*	Weight. (lbs.)	Port End	Length	Largest Diameter	Wrench Flats
1/8	BST-N1	0.03	ST-N1	0.03	SST-N1	0.02	1/8-27 NPTF	0.98	0.65	0.56
1/4	BST-N2	0.07	ST-N2	0.07	SST-N2	0.07	1/4-18 NPTF	1.46	0.87	0.75
3/8	BST-N3	0.12	ST-N3	0.11	SST-N3	0.11	3/8-18 NPTF	1.62	1.59	0.88
1/2	BST-N4	0.23	ST-N4	0.21	SST-N4	0.21	1/2-14 NPTF	1.85	1.30	1.13
3/4	BST-N6	0.33	ST-N6	0.32	SST-N6	0.32	3/4-14 NPTF	2.15	1.59	1.38
1	BST-N8	0.52	ST-N8	0.49	SST-N8	0.48	1-11 1/2 NPTF	2.35	1.88	1.63
1-1/4	BST-N10	0.85	-	-	-	-	1 1/4-11 1/2 NPTF	2.38	2.31	2.00
1-1/2	BST-N12	1.45	-	-	-	-	1 1/2-11 1/2 NPTF	2.81	2.74	2.38

ST Series Nipples- Male Pipe Thread



Body Size	Brass Part No.	Weight. (lbs.)	Steel Part No.	Weight. (lbs.)	303 Stainless Part No.*	Weight. (lbs.)	Port End	Length	Largest Diameter	Wrench Flats
1/8	BST-N1M	0.02	ST-N1M	0.02	SST-N1M	0.02	1/8-27 NPTF	1.04	0.51	0.44
1/4	BST-N2M	0.06	ST-N2M	0.05	SST-N2M	0.05	1/4-18 NPTF	1.53	0.65	0.56
3/8	BST-N3M	0.08	ST-N3M	0.07	SST-N3M	0.08	3/8-18 NPTF	1.69	0.79	0.69
1/2	BST-N4M	0.15	ST-N4M	0.13	SST-N4M	0.13	1/2-14 NPTF	1.94	1.01	0.88
3/4	BST-N6M	0.23	ST-N6M	0.21	SST-N6M	0.22	3/4-14 NPTF	2.19	1.23	1.06
1	BST-N8M	0.46	ST-N8M	0.43	SST-N8M	0.43	1-11 1/2 NPTF	2.51	1.59	1.38
1-1/4	BST-N10M	0.96	-	-	-	-	1 1/4-11 1/2 NPTF	2.85	2.17	1.88
1-1/2	BST-N12M	1.46	-	-	-	-	1 1/2-11 1/2 NPTF	3.25	2.45	2.13

* Prop 65 Warning does not apply to stainless steel part numbers



WARNING: This product can expose you to chemicals including Lead, which is known to the State of California to cause cancer and birth defects or other reproductive harm. For more information go to www.P65Warnings.ca.gov



Parker Water Service Quick Couplings add convenience and efficiency wherever water hoses are frequently connected and disconnected. The durable 4-ball locking mechanism provides a secure connection.

Features:

- Brass and stainless steel construction
- Nitrile seals

Applications include:

- Garden hoses
- Wash down systems
- Mobile water tank lines

Specifications

Body Size	Rated Pressure (psi)	Rated Flow (gpm)	Temperature Range (std seals)
3/4	200	28	-40° to +250° F

Coupler



Body Size	Coupler Part Number	Port End	Length	Largest Diameter	Weight (lbs.)
3/4	1163-60	3/4-11 1/2 NH	1.16	1.21	0.12

Nipple



Body Size	Nipple Part Number	Port End	Overall Length	Exposed Length	Weight (lbs.)
3/4	1163-61	3/4-11 1/2 NH	1.25	0.50	0.08

Coupler Replacement Seal

Part Number	Material
4730001	Nitrile



WARNING: This product can expose you to chemicals including Lead, which is known to the State of California to cause cancer and birth defects or other reproductive harm. For more information go to www.P65Warnings.ca.gov

Hydraulic Quick Couplings

High Flow

H0 Series

Non-Valved, High Pressure

Manual sleeve, sleeve lock



H0 series couplings are high flow, high pressure, steel couplings for a wide variety of applications. Electroless nickel plating provides corrosion resistance.

Features:

- Steel material with electroless nickel plating
- Nitrile seals with PTFE back up ring
- No valving, unrestricted flow
- Standard sleeve lock guards against accidental disconnection
- Rated pressures up to 15,000 psi

Applications:

- Paper and pulp processing
- Refinery systems
- Testing systems

Specifications

Body Size	1/4	3/8	1/2
Rated Pressure (PSI)	15,000	15,000	10,000
Rated Flow (GPM)	3	6	12
Temperature Range (std seals)	-40° to +250°F		

Couplers



Body Size	Part Number	Thread Size	Overall Length	Largest Diameter	Wrench Flats	Weight (lbs.)	Dust Plug Rubber
1/4	HO-251-4FP	1/4-18 NPTF	1.67	1.06	0.94	0.24	TR-37
3/8	HO-371-6FP	3/8-18 NPTF	1.67	1.06	0.94	0.22	TR-37
1/2	HO-501-8FP	1/2-14 NPTF	2.03	1.62	1.25	0.52	DP-50

Optional Seal Materials:

Code	Description	Part Number Example
suffix -E5	Ethylene Propylene seal material- EPR (Couplers)	HO-371-6FP-E5
suffix -E4	Fluorocarbon seal material (Couplers)	HO-371-6FP-E4
suffix -E12	Neoprene seal material (Couplers)	HO-371-6FP-E12

To select proper seal materials, see Fluid Compatibility Chart or contact QCD. Contact QCD for availability..

Nipples



Body Size	Part Number	Thread Size	Overall Length	Exposed Length	Largest Diameter	Wrench Flats	Weight (lbs.)	Dust Plug Rubber
1/4	HO-252-4FP	1/4-18 NPTF	1.40	0.66	0.94	0.81	0.10	TR-37
3/8	HO-372-6FP	3/8-18 NPTF	1.44	0.70	1.08	0.94	0.12	TR-37
1/2	HO-502-8FP	1/2-14 NPTF	2.03	0.86	1.30	1.12	0.26	DP-50

WARNING: This product can expose you to chemicals including Lead, which is known to the State of California to cause cancer and birth defects or other reproductive harm. For more information go to www.P65Warnings.ca.gov



Performance Moldmate Series (1/4", 3/8", 1/2")
Test Fluid: Water (Straight Coupler)

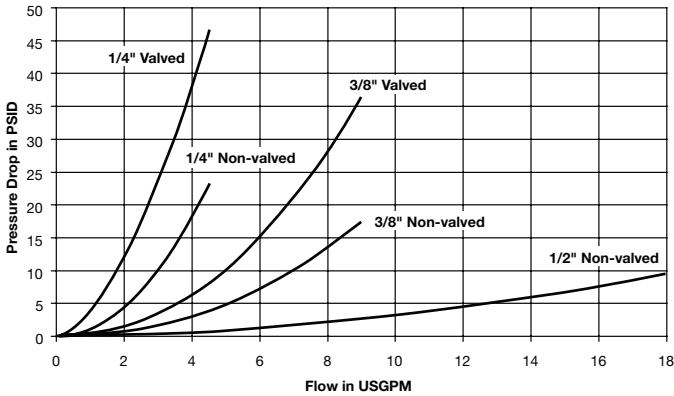

Guidelines for Selection and Use:

Non-valved couplers provide maximum flow for efficient cooling. Valved couplers shut off automatically when disconnected. Valved couplers can be used with either valved or non-valved nipples. A valved nipple, however, must be used with a valved coupler.

Moldmate couplings are rated for 200 psi max pressure. Most thermoplastic and thermoset heat transfer systems have pumps which provide relatively high flow rates at low pressures. Water and water glycol systems usually have capacities ranging from 10 to 40 gpm with most from 10 to 15 gpm. Normal medial opening pressures are 20 to 60 psi for these systems. Heat transfer systems using oil generally operate from 10 to 30 psi. However, their flow rates are usually much higher, requiring the total volume of oil to be circulated at least once per minute.

The number of hose connections in a single mold system results in a cumulative pressure drop. Please note the Pressure Drop vs. Flow Rate chart provided, to select the appropriate size.

Temperature is another important consideration. Parker Moldmate couplings with the standard silicone seal have a temperature capability of -90° to +400°F. Rapid deterioration of the seal and leakage may result if used beyond these limits.

External conditions of temperature, corrosive atmospheres, and other abnormalities may affect coupling performance and must be considered when selection is made. Consult QCD with questions.

Moldmate series couplings are specifically designed for connecting coolant lines to molds and dies on injection molding machinery and die casting equipment. These couplings significantly reduce downtime, by providing a quick and easy way to connect and disconnect lines during mold changes.

Features:

- Rated pressure is 200 psi
- Valved and unvalved options. Valved couplers have silver colored sleeves
- Brass material with standard silicone interface seals are compatible with water and water glycol fluids. Valved versions have a fluorocarbon seal on the poppet.
- Optional fluorocarbon seal for use with oil based media
- Short nipples can be installed recessed below the mold surface enabling more efficient storage and protecting the nipple from damage
- Standard and Push-Lok hose barb ends are available in straight, 45 or 90 degree configurations
- Manual sleeve operation
- Extension nipples are offered in several lengths

Applications:

- Mold coolant lines
- Die casting equipment

Special Order Information:

Standard seal material is Silicone and is compatible with water and water glycol fluids commonly used in heat transfer systems. Fluorocarbon seals are available for use with oil-based media. To specify a Fluorocarbon seal, add the suffix "Y" to the standard moldmate part number, thus: PC206Y.

Specifications			
Body Size	1/4	3/8	1/2
Rated Pressure (psi)	200		
Rated Flow (gpm)	3	6	12

Material	Temperature Range
Standard Silicone seal	-20° to +400° F
*Optional Fluorocarbon seal	-15° to +400° F

* For use with oil based media only



Couplers - Straight

Body Size	Part Number Brass Non-Valved	Weight (lb.)	Part Number Brass - Valved (silver sleeve)	Weight (lb.)	Hose I.D.	Overall Length	Largest Diameter	Overall Length	Largest Diameter	Wrench Flats
						Non-Valved		Valved		
1/4	PC204	0.10	PC204AV	0.10	1/4	1.87	0.63	2.67	0.71	0.63
1/4	PC204-BP*	0.10	PC204AV-BP	0.10	1/4	1.89	0.63	2.52	0.71	0.63
1/4	PC205	0.09	PC205AV	0.10	5/16	1.87	0.63	2.67	0.71	0.63
1/4	PC206	0.09	PC206AV	0.10	3/8	1.87	0.63	2.67	0.71	0.63
1/4	PC206-BP*	0.11	PC206AV-BP	0.13	3/8	2.04	0.63	2.70	0.71	0.63
3/8	PC306	0.24	PC306V	0.27	3/8	2.67	0.96	3.17	1.01	0.88
3/8	PC306-BP*	0.26	PC306V-BP	0.29	3/8	3.15	0.96	3.31	1.01	0.88
3/8	PC308	0.25	PC308V	0.28	1/2	3.15	0.96	3.17	1.01	0.88
3/8	PC308-BP*	0.25	PC308V-BP	0.03	1/2	3.27	0.96	3.43	1.01	0.88
1/2	PC504	0.46	NA	-	1/2	3.55	1.30	-	-	-
1/2	PC504-BP*	0.50	NA	-	1/2	3.68	1.21	-	-	-
1/2	PC506	0.48	NA	-	3/4	3.80	1.21	-	-	-
1/2	PC506-BP*	0.52	NA	-	3/4	3.80	1.21	-	-	-

NA = Not Available

Couplers - 45 Degree

Body Size	Part Number Brass Non-Valved	Weight (lb.)	Part Number Brass - Valved (silver sleeve)	Weight (lb.)	Hose I.D.	Overall Length	Largest Diameter	Wrench Flats	Overall Length	Largest Diameter	Wrench Flats
						Non-Valved			Valved		
1/4	PC224	0.13	PC224AV	0.13	1/4	2.67	0.71	0.56	2.87	0.71	0.63
1/4	PC224-BP*	0.13	PC224AV-BP	0.14	1/4	2.57	0.71	0.56	2.77	0.71	0.63
1/4	PC226	0.13	PC226AV	0.14	3/8	2.71	0.71	0.56	2.91	0.71	0.63
1/4	PC226-BP*	0.26	PC226AV-BP	0.17	3/8	2.74	0.71	0.56	2.94	0.71	0.63
3/8	PC326	0.36	PC326V	0.36	3/8	3.65	0.96	0.88	3.65	1.01	0.88
3/8	PC326-BP*	0.34	PC326V-BP	0.36	3/8	3.75	0.96	0.88	3.75	1.01	0.88
3/8	PC328	0.36	PC328V	0.36	1/2	3.69	0.96	0.88	3.69	1.01	0.88
3/8	PC328-BP*	0.34	PC328V-BP	0.40	1/2	3.88	0.96	0.88	3.88	0.96	0.88
1/2	PC524	0.74	NA	-	1/2	4.18	1.21	1.12	-	-	-
1/2	PC524-BP*	0.78	NA	-	1/2	4.28	1.21	1.12	-	-	-
1/2	PC526	0.76	NA	-	3/4	4.56	1.21	1.12	-	-	-
1/2	PC526-BP*	0.80	NA	-	3/4	4.56	1.21	1.12	-	-	-

* Suffix BP in part number denotes Push-Lok hose barb. Without suffix denotes standard hose barb.
 Push-Lok hose barbs are designed for use with Parker Push-Lok hose and do not require clamps.
 Valved Couplers can be used with either non-valved or valved nipples.

WARNING: This product can expose you to chemicals including Lead, which is known to the State of California to cause cancer and birth defects or other reproductive harm. For more information go to www.P65Warnings.ca.gov





Couplers - 90 Degree



Body Size	Part No. Brass Non-Valved	Weight (lb.)	Part No. Brass Valved (silver sleeve)	Weight (lb.)	Hose I.D.	Overall Length	Non-Valved			Valved		
							Wrench Flats	Largest Diameter	Overall Length	Wrench Flats	Largest Diameter	
1/4	PC214	0.13	PC214AV	0.14	1/4	1.78	0.56	0.71	1.98	0.63	0.71	
1/4	PC214-BP*	0.14	PC214AV-BP	0.14	1/4	1.78	0.56	0.71	1.98	0.63	0.71	
1/4	PC215	0.13	PC215AV	0.14	5/16	1.78	0.56	0.71	1.98	0.63	0.71	
1/4	PC216	0.14	PC216AV	0.15	3/8	1.78	0.56	0.71	1.98	0.63	0.71	
1/4	PC216-BP*	0.16	PC216AV-BP	0.17	3/8	1.80	0.56	0.71	2.00	0.63	0.71	
3/8	PC316	0.31	PC316V	0.31	3/8	2.78	0.88	0.96	2.78	0.88	0.96	
3/8	PC316-BP*	0.37	PC316V-BP	0.37	3/8	2.78	0.88	0.96	2.78	0.88	0.96	
3/8	PC318	0.33	PC318V	0.35	1/2	2.78	0.88	0.96	2.78	0.88	0.96	
3/8	PC318-BP*	0.37	PC318V-BP	0.39	1/2	2.80	0.88	0.96	2.80	0.88	0.96	
1/2	PC514	0.79	NA	-	1/2	3.50	1.12	1.21	-	-	-	
1/2	PC514-BP*	0.83	NA	-	1/2	3.50	1.12	1.21	-	-	-	
1/2	PC516	0.80	NA	-	3/4	3.50	1.12	1.21	-	-	-	
1/2	PC516-BP*	0.84	NA	-	3/4	3.50	1.12	1.21	-	-	-	

* Suffix BP in part number denotes Push-Lok hose barb. Without suffix denotes standard hose barb.
 Push-Lok hose barbs are designed for use with Parker Push-Lok hose and do not require clamps.
 Valved Couplers can be used with either non-valved or valved nipples.

Sub Assemblies and Individual Replacement Parts

Non-valved Sub-assembly (Brass Sleeve)



Body Size	Part No. Brass Non-Valved	Weight (lb.)	Thread Size	Length	Largest Diameter	Wrench Flats
1/4	P208-01A	0.07	1/8-27 NPTF	1.15	0.71	0.56
3/8	P308-01A	0.21	1/4-18 NPTF	1.84	0.96	0.88
3/8	P308-01A-HF	0.20	3/8-18 NPTF	1.84	0.96	0.88
1/2	PC500	0.34	1/2-14 NPTF	2.02	1.21	1.12

Valved Sub-assembly (Silver Colored Sleeve)



Bodies are designed for use with a valve and spring retained by a male pipe fitting (i.e. hose barb). An end fitting is required to retain the internal valving. Valve, valve spring, and end fitting are not included with sub-assembly and must be ordered separately.



Body Size	Part No. Brass Valved	Weight (lb.)	Thread Size	Length	Largest Diameter	Wrench Flats
1/4	P201-01A	0.07	1/8-27 NPTF	1.35	0.71	0.56
3/8	P301-01A	0.21	1/4-18 NPTF	1.84	0.96	0.88



WARNING: This product can expose you to chemicals including Lead, which is known to the State of California to cause cancer and birth defects or other reproductive harm. For more information go to www.P65Warnings.ca.gov



Sub Assemblies and Individual Replacement Parts

Valves (for Valved Sub-assembly)			Valve Springs (for Valved Sub-assembly)		
					
Body Size	Part Number	Material	Body Size	Part Number	Material
1/4	3613001	Brass	1/4	7820123	Stainless
3/8	P300-11S	Brass	3/8	P300-6	Stainless

Replacement Seals (for both Valved and Non-valved)					
					
Body Size	Part Number	Material	Body Size	Part Number	Material
1/4	P200-9A	* Silicone	1/4	P200-9AY	* Fluorocarbon
3/8	P300-9A	* Silicone	3/8	P300-9AY	* Fluorocarbon
1/2	P500-9A	* Silicone	1/2	P500-9AY	* Fluorocarbon

* Note: Bulk seals are not returnable.

Assembly Instruction Sheet (for all sizes & configurations)	
Part Number	
9090065	

 **WARNING:** This product can expose you to chemicals including Lead, which is known to the State of California to cause cancer and birth defects or other reproductive harm. For more information go to www.P65Warnings.ca.gov



Nipples - Female Pipe Thread



Body Size	Part No. Brass	Weight (lb.) Brass	Part No. Steel	Weight (lb.) Steel	Thread Size	Overall Length	Exposed Length**	Wrench Flats	Largest Diameter
1/4	BPN251F	0.02	PN251F	0.02	1/8-27 NPTF	0.97	0.58	0.50	0.58
1/4	BPN252F	0.05	PN252F	0.04	1/4-18 NPTF	1.28	0.89	0.63	0.72
1/4	BPN253F	0.08	PN253F	0.08	3/8-18 NPTF	1.41	1.02	0.75	0.87
3/8	BPN352F	0.05	PN352F	0.05	1/4-18 NPTF	1.48	0.88	0.63	0.72
3/8	BPN353F	0.07	PN353F	0.06	3/8-18 NPTF	1.58	0.98	0.75	0.87

Nipples - Male Pipe Thread



Body Size	Part No. Brass	Weight (lb.) Brass	Part No. Steel	Weight (lb.) Steel	Thread Size	Overall Length	Exposed Length**	Wrench Flats	Largest Diameter	Install Recess Diameter	Depth
1/4	PN250	0.02	-	-	1/16-27 NPTF	0.94	0.54	0.44	0.51	0.69	0.69
1/4	PN251	0.02	PN251S	0.02	1/8-27 NPTF	0.94	0.54	0.44	0.51	0.69	0.69
1/4	PN252	0.03	PN252S	0.03	1/4-18 NPTF	1.13	0.74	0.56	0.67	0.84	0.94
1/4	PN253	0.05	PN253S	0.05	3/8-18 NPTF	1.19	0.79	0.69	0.79	1.00	0.94
3/8	PN352	0.04	PN352S	0.04	1/4-18 NPTF	1.34	0.74	0.56	0.65	1.00	1.09
3/8	PN353	0.06	PN353S	0.06	3/8-18 NPTF	1.38	0.78	0.69	0.79	1.00	1.13
3/8	PN354	0.12	NA	-	1/2-14 NPTF	1.59	0.99	0.88	1.01	1.19	1.25
1/2	PN553	0.12	NA	-	3/8-18 NPTF	1.53	0.77	0.88	1.01	1.25	1.34
1/2	PN554	0.11	NA	-	1/2-14 NPTF	1.70	0.94	0.88	1.01	1.25	1.50
1/2	PN556	0.16	NA	-	3/4-14 NPTF	1.75	0.99	1.06	1.23	1.50	1.56

Valved Nipple



Body Size	Part Number Brass	Thread Size	Overall Length	**Exposed Length	Largest Diameter	Wrench Flats	Weight (lb.)
1/4	BPV252*	1/4-18 NPTF	1.21	0.82	0.67	.56	0.03
3/8	BPV353*	3/8-18 NPTF	1.48	0.88	0.79	.69	0.07

*Valved Nipple must be used with Valved Coupler.

**This dimension represents the portion of the nipple that is exposed when inserted into a moldmate coupler.

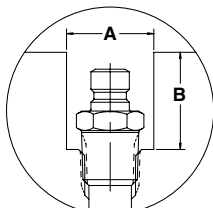

Install Recess Diameter	Depth
0.84	0.94
1.00	1.23



WARNING: This product can expose you to chemicals including Lead, which is known to the State of California to cause cancer and birth defects or other reproductive harm. For more information go to www.P65Warnings.ca.gov

B Hydraulics



Nipples - Moldmate Extension

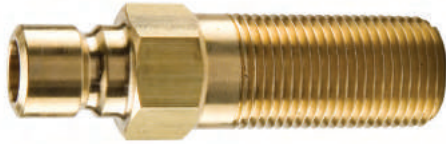

Body Size	Part Number Brass	Weight (lb.) Brass	Thread Size	Overall Length	Exposed Length	Wrench Flats	Largest Diameter
1/4	PN250-25	0.04	1/16-27 NPTF	2.50	.69	3/8	0.43
1/4	PN250-40	0.06	1/16-27 NPTF	4.00	.81	3/8	0.43
1/4	PN250-55	0.09	1/16-27 NPTF	5.50	.81	3/8	0.43
1/4	PN251-25	0.06	1/8-27 NPTF	2.50	.69	7/16	0.51
1/4	PN251-40	0.10	1/8-27 NPTF	4.00	1.00	7/16	0.51
1/4	PN251-55	0.13	1/8-27 NPTF	5.50	1.00	7/16	0.51
1/4	PN251-70	0.17	1/8-27 NPTF	7.00	1.00	7/16	0.51
1/4	PN251-85	0.21	1/8-27 NPTF	8.50	1.00	7/16	0.51
1/4	PN252-25	0.09	1/4-18 NPTF	2.50	.88	9/16	0.65
1/4	PN252-40	0.15	1/4-18 NPTF	4.00	1.25	9/16	0.65
1/4	PN252-55	0.22	1/4-18 NPTF	5.50	1.25	9/16	0.65
1/4	PN252-70	0.27	1/4-18 NPTF	7.00	1.25	9/16	0.65
1/4	PN252-85	0.33	1/4-18 NPTF	8.50	1.25	9/16	0.65
3/8	PN351-25	0.07	1/8-27 NPTF	2.50	.88	9/16	0.65
3/8	PN351-40	0.11	1/8-27 NPTF	4.00	1.00	9/16	0.65
3/8	PN351-55	0.15	1/8-27 NPTF	5.50	1.00	9/16	0.65
3/8	PN351-70	0.18	1/8-27 NPTF	7.00	1.00	9/16	0.65
3/8	PN351-85	0.22	1/8-27 NPTF	8.50	1.00	9/16	0.65
3/8	PN352-25	0.09	1/4-18 NPTF	2.50	.88	9/16	0.65
3/8	PN352-40	0.15	1/4-18 NPTF	4.00	1.25	9/16	0.65
3/8	PN352-55	0.21	1/4-18 NPTF	5.50	1.25	9/16	0.65
3/8	PN352-70	0.27	1/4-18 NPTF	7.00	1.25	9/16	0.65
3/8	PN352-85	0.33	1/4-18 NPTF	8.50	1.25	9/16	0.65
3/8	PN353-25	0.12	3/8-18 NPTF	2.50	1.00	11/16	0.79
3/8	PN353-40	0.20	3/8-18 NPTF	4.00	1.25	11/16	0.79
3/8	PN353-55	0.28	3/8-18 NPTF	5.50	1.25	11/16	0.79
3/8	PN353-70	0.37	3/8-18 NPTF	7.00	1.25	11/16	0.79
3/8	PN353-85	0.45	3/8-18 NPTF	8.50	1.25	11/16	0.79



WARNING: This product can expose you to chemicals including Lead, which is known to the State of California to cause cancer and birth defects or other reproductive harm. For more information go to www.P65Warnings.ca.gov

Hydraulic Quick Couplings Miniature

DM Series Miniature

Double shut-off, push to connect



DM Series are special purpose miniature couplings that offer double shut-off and push to connect operation in a small envelope. The 1/8 inch brass couplings are nickel plated with standard fluorocarbon seals.

Features:

- Rated pressure is 250 psi
- Double shut-off valving
- Fluorocarbon seals
- Standard end configurations are female and male pipe thread

Applications:

- Dental equipment
- Lubrication lines
- Fluid transfer
- Coolant lines

Performance

DM Series (1/8")
Test Fluid: Water

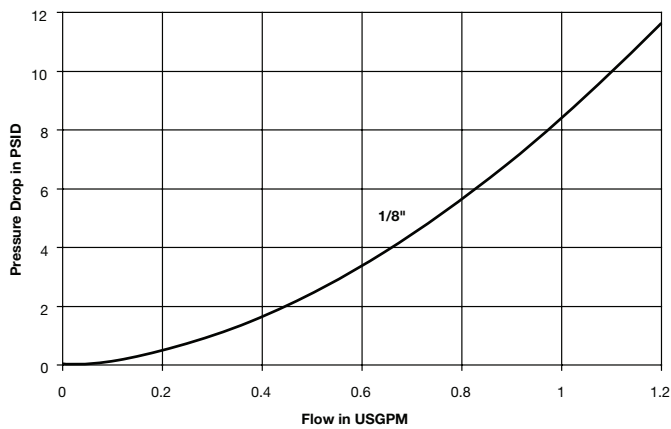

Specifications

Body Size (in.)	1/8
Rated Pressure (psi)	250
Locking Device (balls)	5
Rated Flow (gpm)	0.8
Temperature Range	-15°F to +400°F

How To Order

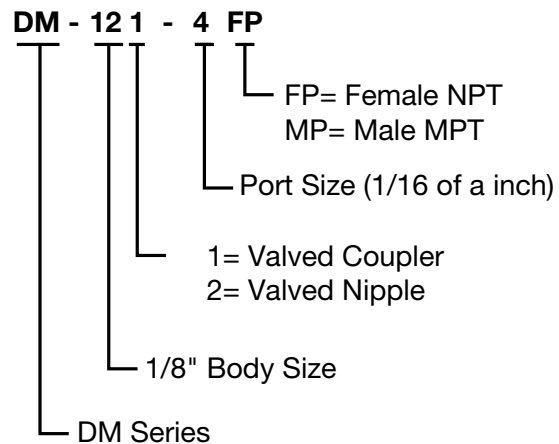



Couplers - Female Pipe Thread



Body Size	Part Number	Weight (lb.)	Thread Size	Overall Length	Largest Diameter	Wrench Flats
1/8	DM-121-2FP	0.06	1/8-27 NPTF	1.42	0.63	0.55
1/8	DM-121-4FP	0.10	1/4-18 NPTF	1.81	0.78	0.67

Couplers - Male Pipe Thread



Body Size	Part Number	Weight (lb.)	Thread Size	Overall Length	Largest Diameter	Wrench Flats
1/8	DM-121-2MP	0.06	1/8-27 NPTF	1.50	0.63	0.55
1/8	DM-121-4MP	0.07	1/4-18 NPTF	1.61	0.63	0.55

Nipples - Female Pipe Thread



Body Size	Part Number	Weight (lb.)	Thread Size	Overall Length	Exposed Length*	Largest Diameter	Wrench Flats
1/8	DM-122-2FP	0.05	1/8-27 NPTF	1.56	1.03	0.63	0.55
1/8	DM-122-4FP	0.09	1/4-18 NPTF	1.97	1.44	0.78	0.67

* This dimension represents the portion that is exposed when a nipple is inserted into a Parker DM Series coupler.

Nipples - Male Pipe Thread



Body Size	Part Number	Weight (lb.)	Thread Size	Overall Length	Exposed Length*	Largest Diameter	Wrench Flats
1/8	DM-122-2MP	0.05	1/8-27 NPTF	1.65	1.12	0.63	0.55
1/8	DM-122-4MP	0.06	1/4-18 NPTF	1.77	1.24	0.63	0.55

* This dimension represents the portion that is exposed when a nipple is inserted into a Parker DM Series coupler.



WARNING: This product can expose you to chemicals including Lead, which is known to the State of California to cause cancer and birth defects or other reproductive harm. For more information go to www.P65Warnings.ca.gov

When ordering Parker coupler bodies and nipples, please state the part number of each type of coupler body and each type of nipple desired. List coupler bodies and nipples as separate items rather than in combinations. Be sure to double check thread or hose sizes of items required.

Many of Parker's coupling products are available with unique non-standard options well suited to very specific applications. Examples of unusual end use applications might include: high temperatures (above 250° F), extremely caustic/corrosive solutions passing through the coupling, external/environmental corrosion situations, or other high wear and tear situations such as dragging the product along the ground. Please see the Fluid Compatibility Chart at the end of the catalog for a guide in selecting material for various media. It is always recommended that the Quick Coupling Division be contacted with any questions concerning specific product application needs.

Typically, a prefix or suffix is added to the base part number to specify a non-standard O-ring seal, or special option such as a sleeve lock. The Optional Seals Suffix chart illustrates the designations.

Optional Features

- Prefix "HD" for Heavy Duty Nipple
- Suffix "SL" for Coupler Sleeve-Lok
- Suffix "P" for Poppet Valve
- Suffix "BP" for Push-Lok Hose Barb
- Suffix "VA" for Valve Actuator

Optional Seals Suffix*

No suffix is required when ordering products with the standard Nitrile seals. When specifying an optional seal, refer to the following chart to determine the appropriate suffix.

Coupling Series	Ethylene Propylene	Fluoro-carbon	Neoprene	Perfluoro-elastomer
60 Series	W	Y	Z	***
6600 Series	W	Y	Z	***
SM Series	E5	E4	E12	***
HP Series	E5	E4	E12	***
4000 Series	W	Y	Z	N/A
4200 Series	W	Y	Z	N/A
NS Series	E5	E4	N/A	***
FF Series Std. is E49	E5	E4	N/A	***
FH Series	E5	E4	N/A	***
FS Series	E5	STD	E12	***
6100 Series	W	Y	Z	N/A
5000 Series	W	Y	Z	N/A
8200 Series	W	Y	Z	N/A
9200 Series	W	Y	Z	N/A
3000 Series	Available with Polyurethane only (no suffix needed)			
TC Series	Available with Fluorocarbon only (no suffix needed)			
1141 Series	Available with Polyurethane only (no suffix needed)			
ST Series	W	Y	Z	
Water Service	Available with Nitrile only			
HO Series	E5	E4	E12	N/A
Moldmate Series Std. is Silicone	N/A	Y**	N/A	N/A

N/A = Not Available

STD = Standard (No Suffix Needed)

* To select proper seal materials, see Fluid Compatibility Chart in Appendices section, or contact your Parker Quick Coupling Distributor.

** Fluorocarbon seal available for use only with oil based media, not water glycol.

*** Contact QCD for Perfluoroelastomer seal options.



Diagnostic Products 4054-3/UK



Industrial Products 4083-4/UK



For information on Parker's Diagnostic and Industrial solutions, review these SensoControl catalogs or visit Parker.com/SensoControl.

Test Port Coupling Selection Guide									
Test Port	Valving Style	Body Size	Material*			Locking Mechanism	Standard Seal Material	Rated Pressure	Temp Range**
			Br	SS	S				
PD Series	Flush Face	1/8"	■	■	■	Ball	Nitrile	6000 psi	-40° to +250° F
PDP Series	Ball (Nipple only)	1/8"	■	■	■	Ball	Nitrile	6000 psi	-40° to +250° F
EMA3 Series	Poppet	1/8"	■	■	■	Threads	Nitrile/Fluorocarbon	9000 psi	-15° to +250° F

* See Fluid Compatibility chart and/or consult QCD for questions regarding proper material for specific applications.

CODE: Br = Brass; SS = Stainless Steel; S = Steel

** Temperature Range for standard seal material



PD Series couplings provide easy connection for mechanical gauges or specialized diagnostic equipment like SensoControl®.

Typically, PD or BPD nipples are permanently mounted in the system at threaded test ports, in rigid tubing or in hose assemblies. PD couplers are attached to test instruments.

Couplers align to the mating nipples without threading. This allows gauges, transducers and other test equipment to be snapped into place without difficulty.

Note: Protective dust caps play a crucial role in the life of a quick coupling and no purchase is complete without the selection of an appropriate dust cap.

Features

- Flush-face poppet valves minimize air inclusion and spillage, provide easy-to-clean surfaces, and help to prevent contamination.
- Grip-tight knurled sleeves help to make connecting and disconnecting easy, even while wearing gloves.
- Nipples are machined from high tensile steel for strength to withstand 6000 PSI continuous operating pressure. BPD nipples offer features similar to the standard steel PD nipples with the added feature of a brass body.
- PD nipples are designed to meet or exceed SAE J1502 and ISO 15171-1 design and performance specifications.
- End connections include pipe, O-ring, metric thread, bulkhead, 37° Flare, ORFS and bite-type.

Ordering Information

Coupler / Nipple Material

- Prefix "B" for Brass Body with Fluorocarbon seal
- Prefix "SS" for Stainless Steel Body with Fluorocarbon seal
- Standard body material is Steel with Nitrile seal
- Suffix "-6" to include Dust Cap with Nipple

Optional Seals Suffix*

No suffix is required when ordering products with the standard Nitrile seals. When specifying an optional seal, refer to the following chart to determine the appropriate suffix.

Coupling Series	Ethylene Propylene	Fluorocarbon	Neoprene
PD Series	W	Y	Z

*To select proper seal materials, see Fluid Compatibility Chart in Appendix section, or contact your Parker Quick Coupling Distributor.

PD Series Dust Cap



Body Size	Dust Cap Part No.
1/8	PD6-285

Specifications - Body Size 1/8"

Description	PD Coupler	PD Nipple	BPD Nipple	Assembly
Part Number	PD242	PD361	BDP343Y	—
Body Material (Steel)	Carbon Steel	High Tensile Steel	Brass	—
Rated Pressure (PSI)	6000	6000	300	6000
Temperature Range (STD Seals) Nitrile	-40°F to +250°F		-15°F to +400°F Fluorocarbon	-40°F to +250°F
Rated Flow (GPM)	—	—	—	0.8
Max. Recommended Flow (GPM)	—	—	—	4.0
Burst Pressure (PSI/Min)	23,000	40,000	—	17,000
Vacuum Data (Inches Hg)	27.5	27.5	27.5	27.5
Pressure Drop at Rated Flow (PSI) with 200 SUS Fluid	—	—	—	56
Spillage at 15 PSI (ml)-Assembly	0.1 per disconnect			
Air Inclusion (ml)-Assembly	0.02 per connect			
Connect Force-Assembly	41 Lbs. (100 PSI)			
Disconnect Force-Assembly	20 Lbs. (100 PSI)			

Couplers- Female Thread



Body Size	Part Number	Thread Size	Overall Length	Wrench Flats	Largest Diameter	Weight
1/8	PD222	1/8-27 NPTF	1.67	0.81	0.96	0.20
1/8	PD240	7/16-20 UNF	2.12	0.81	0.96	0.26
1/8	PD242	1/4-18 NPTF	2.12	0.81	0.96	0.25
1/8	SSPD242Y**	1/4-18 NPTF	2.12	0.81	0.96	0.25
1/8	PD260	9/16-18 UNF	2.12	0.81	0.96	0.24
1/8	PD248	1/4-19BSPP	2.12	1.19		0.38
1/8	PD288	1/2-14BSPP	2.52	1.19		0.35

Couplers- Male Pipe Thread



Body Size	Part Number	Thread Size	Overall Length	Wrench Flats	Largest Diameter	Weight
1/8	PD243	1/4-18 NPTF	2.26	0.81	0.96	0.23

Nipples- Female Pipe Thread



Body Size	Part Number	Thread Size	Overall Length	Exposed Length	Wrench Flats	Largest Diameter	Weight
1/8	PD322	1/8-27 NPTF	1.48	0.78	0.56	0.65	0.06
1/8	PD342	1/4-18 NPTF	1.63	0.93	0.75	0.87	0.12

Nipples- Male Pipe Thread



Body Size	Part Number	Thread Size	Overall Length	Exposed Length	Wrench Flats	Largest Diameter	Weight
1/8	PD323	1/8-27 NPTF	1.55	0.85	0.69	0.79	0.17
1/8	BPD323Y*	1/8-27 NPTF	1.44	0.74	0.63	0.72	0.17
1/8	BPD343Y*	1/4-18 NPTF	1.48	0.78	0.69	0.79	0.06
1/8	PD343	1/4-18 NPTF	1.48	0.78	0.69	0.79	0.06
1/8	SSPD343Y**	1/4-18 NPTF	1.48	0.78	0.69	0.79	0.06
1/8	PD363	3/8-18 NPTF	1.50	1.13	0.81	0.96	0.09

* BPD designates brass body, Fluorocarbon seal standard
 ** SSPD designates 316SS body, Fluorocarbon seal standard



Note: Add -6 to Nipple part number to include dust cap, for example PD343-6

Nipples- Male Metric Thread



Body Size	Part Number	Thread Size Metric	Overall Length	Exposed Length	Wrench Flats	Largest Diameter	Weight
1/8	PD357	M10 x 1.0	1.80	1.10	0.69	0.79	0.17
1/8	PD397	M12 x 1.5	1.85	1.05	0.69	0.79	-
1/8	PD367C	M14 x 1.5	1.50	0.80	0.75	0.87	0.07
1/8	PD3107	M16 x 1.5	1.54	0.84	0.88	1.01	0.08
1/8	PD3127	M18 x 1.5	1.60	0.90	0.94	1.08	0.09
1/8	PD3147	M20 x 1.5	1.50	0.80	0.75	0.87	0.07
1/8	BPD3167	M22 x 1.5	1.65	0.95	1.12	1.30	-

Nipples- Male Straight Thread



Body Size	Part Number	Thread Size ORB	Overall Length	Exposed Length	Wrench Flats	Largest Diameter	Weight
1/8	PD331	3/8-24 UNF	1.80	1.10	0.69	0.79	0.17
1/8	PD341	7/16-20 UNF	1.60	0.90	0.69	0.79	0.08
1/8	PD351	1/2-20 UNF	1.32	0.62	0.63	0.72	0.05
1/8	PD361	9/16-18 UNF	1.32	0.62	0.69	0.79	0.06

Nipples- Bulkhead Triple-Lok



Body Size	Part Number	Thread Size	Tube Size	Overall Length	Exposed Length	Wrench Flats	Largest Diameter	Weight
1/8	PD345	7/16-20 UNF	1/4	2.92	2.22	0.81	0.94	0.19
1/8	PD355	1/2-20 UNF	5/16	2.92	2.22	0.81	0.94	0.19
1/8	PD365	9/16-18 UNF	3/8	3.00	2.30	0.81	0.94	0.20

Nipples- Bulkhead Seal-Lok



Body Size	Part Number	Thread Size	Tube Size	Overall Length	Exposed Length	Wrench Flats	Largest Diameter	Weight
1/8	PD346	9/16-18 UNF	1/4	2.98	2.27	0.81	0.94	-
1/8	PD366	11/16-16 UNF	3/8	3.08	2.37	1.00	1.16	-
1/8	PD386	13/16-16 UNF	1/2	3.18	2.47	1.12	1.30	-

* Note: Add -6 to part number to include dust cap, for example PD343-6

* BPD designates brass body, Fluorocarbon seal standard

** SSPD designates 316SS body, Fluorocarbon seal standard

Tube End Nipples*- Triple Lok



Body Size	Part Number Steel	Tube Size	Overall Length	Exposed Length	Weight
1/8	PD34BTX	1/4	1.64	0.94	0.10
1/8	PD36BTX	3/8	1.66	0.96	0.09



1/8	PD38BTX	1/2	1.17	0.47	0.12
1/8	PD312BTX	3/4	1.39	0.69	0.27

* Tube end nipples are designed to meet the performance standards of the tube or hose fitting connection, which may or may not meet SAE J1502 Standards

Tube End Nipples*- Seal Lok



Body Size	Part Number Steel	Tube Size	Overall Length	Exposed Length	Weight
1/8	PD34BTL	1/4	2.18	1.48	0.12
1/8	PD36BTL	3/8	2.30	1.60	0.14



1/8	PD38BTL	1/2	1.57	0.83	0.13
1/8	PD310BTL	5/8	1.16	0.46	0.19

* Tube end nipples are designed to meet the performance standards of the tube or hose fitting connection, which may or may not meet SAE J1502 Standards



Note: Add -6 to Nipple part number to include dust cap, for example PD343-6



PDP Series couplings provide easy connection for mechanical gauges or specialized diagnostic equipment like SensoControl. Typically, PDP nipples are permanently mounted in the system at threaded test ports, in rigid tubing or in hose assemblies. PDP couplers are attached to test instruments.

Locking balls align the couplers to the mating nipples without threading, so gauges, transducers and other test equipment can be snapped into place without difficulty.

Parker's PDP Series couplings offer the advantages of PD couplings, but are designed to connect easily and quickly under full system pressure up to 6000 PSI (operating).

PDP couplers and nipples push to connect with a constant force of only six pounds. Then the coupler base is turned to open the valve and complete the connection. In the connected position, the coupler base blocks the retracting sleeve to prevent accidental disconnects.

Features

- Made to connect under pressure up to 6000 psi
- Grip-tight knurled sleeves help to make connecting and disconnecting easy, even while wearing gloves.
- Nipples are machined from high tensile steel for strength to withstand 6000 PSI continuous operating pressure.
- End connections include pipe, O-ring, 37° Flare and ORFS
- Durable Ball Valve Nipple.
- Coupler is unvalved to allow gauges and transducers to return to zero when disconnected.

Specifications - Body Size 1/8"

Description	PDP Coupler	PDP Nipple	Assembly
Body Material (Steel)	Carbon Steel	High Tensile Steel	—
Rated Pressure (PSI)	-	6000	6000
Temperature Range (STD Seals) Nitrile	-40°F to +250°F		
Connect Force-Assembly	6 Lbs. (0-6000 PSI)		
Disconnect Force-Assembly	7 Lbs. (0-6000 PSI)		

PD Series Dust Cap

	Body Size	Dust Cap Part No.
	1/8	PD6-285



Note: Add -6 to Nipple part number to include dust cap, for example PDP343-6

Ordering Information

Coupling / Nipple Material:
Standard body material is Steel
Standard seal material is Nitrile

Optional Seals Suffix*

No suffix is required when ordering products with the standard Nitrile seals. When specifying an optional seal, refer to the following chart to determine the appropriate suffix.

Coupling Series	Ethylene Propylene	Fluorocarbon	Neoprene
PDP Series	W	Y	Z

*To select proper seal materials, see Fluid Compatibility Chart in Appendix section, or contact your Parker Quick Coupling Distributor.

Coupler - Female Thread



Body Size	Part Number Steel	Thread Size	Overall Length	Largest Diameter	Wrench Flats	Weight
1/8	PDP242	1/4-18 NPTF	2.15	0.96	0.81	-
1/8	PDP288	1/2-14BSPP	2.58		1.19	0.35

Nipples - Male Pipe Thread



Body Size	Part Number	Thread Size	Overall Length	Exposed Length	Wrench Flats	Largest Diameter	Weight
1/8	PDP323	1/8-27 NPTF	2.02	1.46	0.69	0.79	0.26
1/8	PDP343	1/4-18 NPTF	1.48	0.93	0.69	0.79	0.12

Nipples - Male Straight Thread



Body Size	Part Number	Thread Size ORB	Overall Length	Exposed Length	Wrench Flats	Largest Diameter	Weight
1/8	PDP341	7/16-20 UNF	2.06	1.50	0.69	0.79	0.12
1/8	PDP361	9/16-18 UNF	1.48	0.93	0.69	0.79	0.07

Nipples - Triple-Lok



Body Size	Part Number	Tube Size	Overall Length	Exposed Length	Wrench Flats	Largest Diameter	Weight
1/8	PDP34BTX	1/4	2.11	1.55	0.69	.80	-
1/8	PDP36BTX	3/8	2.13	1.57	0.69	.80	-

Nipples - Seal-Lok



Body Size	Part Number	Tube Size	Overall Length	Exposed Length	Wrench Flats	Largest Diameter	Weight
1/8	PDP34BTL	1/4	2.65	2.09	.69	.80	-
1/8	PDP36BTL	3/8	2.77	2.21	.81	.94	-



EMA couplings provide easy diagnostic connections for Parker SensoControl® equipment or mechanical gages. EMA test points are typically permanently plumbed into a fluid system at locations where pressure measurements are required for maintenance or testing. Integral pressure cap protects the test point from damage and prevents contamination of the fluid system. Proven twist-to-connect design allows the test points to be connected even when the system is in operation and the test points are pressurized. EMA's compact design and optional high pressure hose assemblies allow extra flexibility for the location of system test points.

Although designed primarily for diagnostic applications, EMA fittings and hose assemblies are ideal for a wide range of applications that require compact high pressure connections and limited flow rates.

Features

- Knurled sleeve allows simple twist-to-connect operation without the use of tools
- Rugged design allows connect-under-pressure operation up to 5800 psi
- Maximum rated working pressure of 9000 psi exceeds the requirements of most applications
- Integral threaded dust cap protects the test point from damage and contamination
- EMA fittings are machined from solid barstock and protected with Chromium-6 Free plating.
- Stainless steel springs for corrosion resistance
- Elastomeric interface and valve seals provide leak free operation
- Compact design and optional high pressure hose assemblies provide flexibility for tight space requirements

Specifications

Body Size	1/8
Rated Pressure (psi)	9000 PSI
Max Connect-Under-Pressure (psi)	5800
Rated Flow (GPM)	0.8
Body Material	Chromium-6 Free Plated Steel
Standard Seal Material	Nitrile (external) Fluorocarbon (internal)
Temperature Range (std. seals)	-15° to +250° F

Male Pipe Thread



New Part Number	Old Part Number	Port Thread Size	Wrench Flats	Interface Thread Size	Overall Length	Weight
EMA3/1/8NPTCF	EMA3/1/8NPT	1/8-27NPT	17mm	M16 X 2.0	1.81	0.15
EMA3/1/4NPTCF	EMA3/1/4NPT	1/4-18NPT	17mm	M16 X 2.0	1.98	0.16
EMA3/1/4NPT71 Stainless Steel	EMA3/1/4NPT71 Stainless Steel	1/4-18NPT	17mm	M16 X 2.0	1.95	0.16

SAE Straight Thread



New Part Number	Old Part Number	Port Thread Size	Wrench Flats	Interface Thread Size	Overall Length	Weight
EMA3/7/16UNFCF*	EMA3/7/16-20UNF-2A	7/16-20UNF-2A	17mm	M16 X 2.0	1.88	0.15
EMA3/9/16UNFCF*	EMA3/9/16-18UNF-2A	9/16-18UNF-2A	19mm	M16 X 2.0	1.88	0.17

* O-Ring seal on port

Metric Straight Thread



New Part Number	Old Part Number	Port Thread Size	Wrench Flats	Interface Thread Size	Overall Length	Weight
EMA3/8X10RCF*	EMA3/M8X10R	M8X1	17mm	M16 X 2.0	1.81	0.15
EMA3/10X1EDCF**	EMA3/10X1ED	M10X1	17mm	M16 X 2.0	1.85	0.15
EMA3/12X1.5EDCF**	EMA3/12X1.5ED	M12X1.5	17mm	M16 X 2.0	1.94	0.16
EMA3/14X1.5EDCF**	EMA3/14X1.5ED	M14X1.5	19mm	M16 X 2.0	1.94	0.16

* O-Ring seal on port **Molded seal on port

British Parallel Pipe



New Part Number	Old Part Number	Port Thread Size	Wrench Flats	Interface Thread Size	Overall Length	Weight
EMA3/1/8EDCF**	EMA3/1/8ED	1/8 BSPP	19mm	M16 X 2.0	1.77	0.15
EMA3/1/4EDCF**	EMA3/1/4ED	1/4 BSPP	19mm	M16 X 2.0	1.94	0.16
EMA3/3/8EDCF**	EMA3/3/8ED	3/8 BSPP	21mm	M16 X 2.0	1.94	0.16

**Molded seal on port

EMA Gauge Adapter



Part Number	Port Thread Size	Wrench Flats	Interface Thread Size	Overall Length	Weight
MAV1/4NPTMA3CF	1/4-18NPT	19mm	M16 X 2.0	2.22	0.16
MAV1/4NPTMA3KMCF Includes Dust Cap	1/4-18NPT	19mm	M16 X 2.0	2.22	0.23

EMA Gauge Adapter



Part Number	Port Thread Size	Wrench Flats	Interface Thread Size	Overall Length	Weight
MAVMD1/4NPTMA3CF	1/4-18NPT	19mm	M16 X 2.0	2.22	0.18
SCA-7/16-EMA-3	7/16-20UNF	19mm	M16 X 2.0	1.60	

Union



New Part Number	Old Part Number	Port Thread Size	Wrench Flats	Interface Thread Size	Overall Length	Weight
EMA3VSCF	EMA3VS	M16 X 2.0	17mm	M16 X 2.0	1.65	0.11

Transducer Adapters BSPP Thread*



Part Number	Port Thread Size	Wrench Flats	Interface Thread Size	Overall Length	Weight
SCA-1/4-EMA-3CF	1/4-19BSPP	27mm	M16 X 2.0	32mm	0.30
SCA-1/2-EMA-3	1/2-14BSPP	27mm	M16 X 2.0	36mm	0.30

* Note: For old style M22X1.5 thread contact QCD

Flexible Hose

	Part Number	Length (in.)	Length (mm)	Thread Size
	SMA3-200CF	7.90	200	M16 x 2.0
	SMA3-400CF	15.75	400	M16 x 2.0
	SMA3-800CF	31.50	800	M16 x 2.0
	SMA3-1000CF	39.38	1000	M16 x 2.0
	SMA3-2000CF	78.75	2000	M16 x 2.0
	SMA3-4000CF	157.50	4000	M16 x 2.0

Note: Other lengths available upon request.
Maximum pressure rating for test hose is 9000 psi.

Hose Assembly

	Part Number	Length (in.)	Length (mm)	Coupling
	PDH-19	19	483	PD
	PDH-32	32	813	PD
	PDH-120	120	3048	PD
	PDH-240	240	6096	PD

Note: Maximum pressure rating for test hose is 6000 psi.



These diagnostic fluid sampling products are designed to provide an easy access point for obtaining fluid samples. A permanently mounted test point eliminates the need to shut down or break lines when taking samples and reduces the chances of contamination. Fluid analysis is crucial in both engines and hydraulic systems as it can reveal problems with filtration and other internal components. Early detection can prevent costly repairs, unscheduled maintenance and production downtime. These fluid sampling nipples should be installed in either low pressure or return lines. For the most accurate monitoring, fluid samples should be constantly taken from the same location.

Specifications

Body Size	1/8
Rated Pressure (PSI)	500 PSI
Seal Material	Fluorocarbon
Temperature Range (std. seals (Fluorocarbon))	-40° to +250° F

Couplers- Female Thread



Body Size	Part Number	Female Thread NPTF	Female Thread ORB	Overall Length	Wrench Flats	Largest Diameter	Weight
1/8	PDFS242	1/4-18	-	2.15	0.81	0.96	0.25

Nipples- Male Thread



Body Size	Part Number	Thread Size ORB or NPTF	Thread Size Metric	Overall Length	Exposed Length	Wrench Flats	Largest Diameter	Weight
1/8	BPDFS341	7/16-20 ORB		1.60	0.90	0.69	0.79	0.08
1/8	BPDFS343	1/4-18 NPTF		1.48	0.78	0.69	0.79	0.06
1/8	PDFS-PROBE*		NA	-	-	-	-	-

Fluorocarbon seal is standard.
Dust Cap PD6-285 is recommended.



Parker's in-line diagnostic tees are designed to work with the SensoControl diagnostic couplings.

The tee fittings are offered in a standard and custom line of fixed flow control orifice fittings. These products are available as standard in two Parker product series — ORFS and 37° flare, and as a custom option in virtually any orifice size, fitting series, size, material and configuration.

Features • Designed around the two most common hydraulic tube/hose interfaces: O-ring face seal (Parker Seal-Lok) and 37° fl are (JIC / Parker Triple-Lok)

- ORFS and 37° fl are swivel feature offers unlimited positioning without displacing port adapter
- Uses elastomeric sealing: SAE -4 (7/16-20 UNF) port as universal diagnostic port per SAE J1926-1/ISO 11926
- Enlarged and lengthened body hex ensures that diagnostic port offers full thread engagement and pressure capability
- Adaptable to Parker's line of diagnostic and fluid sampling tips including: EMA3, PD and PDFS, as well as various direct connecting electronic/mechanical pressure gauges

Tee Fittings

Part Number (PD)	Type	Picture	Port #1	Port #2	L (in)	Hex (in)	Weight (LBs)
4-4 LOHL6G5TP-S-PD	ORFS		1/4	1/4	1.83	1.063	0.3535
6-4 LOHL6G5TP-S-PD	ORFS		3/8	3/8	1.95	1.063	0.3855
8-4 LOHL6G5TP-S-PD	ORFS		1/2	1/2	2.18	1.063	0.4325
10-4 LOHL6G5TP-S-PD	ORFS		5/8	5/8	2.40	1.125	0.5430
12-4 LOHL6G5TP-S-PD	ORFS		3/4	3/4	2.59	1.25	0.7475
16-4 LOHL6G5TP-S-PD	ORFS		1	1	2.85	1.50	1.0570
4-4 XHX6G5TP-S-PD	37° Flare		1/4	1/4	1.99	1.063	0.3275
6-4 XHX6G5TP-S-PD	37° Flare		3/8	3/8	2.08	1.063	0.3390
8-4 XHX6G5TP-S-PD	37° Flare		1/2	1/2	2.30	1.063	0.3780
10-4 XHX6G5TP-S-PD	37° Flare		5/8	5/8	2.49	1.125	0.4380
12-4 XHX6G5TP-S-PD	37° Flare		3/4	3/4	2.66	1.25	0.5765
16-4 XHX6G5TP-S-PD	37° Flare		1	1	2.99	1.50	0.8280

Part Number (EMA)	Type	Picture	Port #1	Port #2	L (in)	Hex (in)	Weight (LBs)
4-4 LOHL6G5TP-S-EMA	ORFS		1/4	1/4	1.83	1.063	0.4120
6-4 LOHL6G5TP-S-EMA	ORFS		3/8	3/8	1.95	1.063	0.4440
8-4 LOHL6G5TP-S-EMA	ORFS		1/2	1/2	2.18	1.063	0.4925
10-4 LOHL6G5TP-S-EMA	ORFS		5/8	5/8	2.40	1.125	0.6025
12-4 LOHL6G5TP-S-EMA	ORFS		3/4	3/4	2.59	1.25	0.8015
16-4 LOHL6G5TP-S-EMA	ORFS		1	1	2.85	1.50	1.1140
4-4 XHX6G5TP-S-EMA	37° Flare		1/4	1/4	1.99	1.063	0.3865
6-4 XHX6G5TP-S-EMA	37° Flare		3/8	3/8	2.08	1.063	0.3960
8-4 XHX6G5TP-S-EMA	37° Flare		1/2	1/2	2.30	1.063	0.4385
10-4 XHX6G5TP-S-EMA	37° Flare		5/8	5/8	2.49	1.125	0.4965
12-4 XHX6G5TP-S-EMA	37° Flare		3/4	3/4	2.66	1.25	0.6360
16-4 XHX6G5TP-S-EMA	37° Flare		1	1	2.99	1.50	0.8900

Note: Assembly values are for dry, unlubricated swivel nut connections



Description

These popular Quick Coupling Key Chains are constructed of anodized aluminum and are available in an array of colors. The original design, nickel plated version can be ordered as well.

Part Number	Sleeve Color
KEY-BK	Black
KEY-BU	Blue
KEY-GR	Green
KEY-RD	Red
KEY-CL	Clear
KEY-NI	Old style nickel plated



WARNING: This product can expose you to chemicals including Lead, which is known to the State of California to cause cancer and birth defects or other reproductive harm. For more information go to www.P65Warnings.ca.gov



Thermoplastic Quick Couplings

Coupling Selection Guide	C-2
Spectrum Series	C-3
Couplers	C-4, C-5
Nipples	C-5

Thermoplastic Coupling Selection Guide

Series	Valving	Coupler Style	Body Size (in.)	Material	Locking Mechanism	Std. Seal Material	Temp. Range	Rate Pressure
General Purpose								
Spectrum™ Series	Valved or Unvalved	Push-to-connect	1/8 & 3/8	Acetal 316 SS	Finger Lock	Nitrile	0° to +180° F	0 to 145 PSI
Spectrum™ Series	Valved or Unvalved		1/8 & 3/8	PVDF/SS 316 SS*	Finger Lock	Fluorocarbon	0° to +250° F	0 to 115 PSI
Spectrum™ Series	Valved or Unvalved		3/8	PVDF/ PEEK™*	Finger Lock	Fluorocarbon	0° to +250° F	15 to 115 PSI

*Spectrum Series PVDF material options are subject to quote from the division



Parker's Spectrum™ Series couplers are the most advanced engineered thermoplastic couplings available. Spectrum Series couplings combine compact size, high flow capability, and light weight design to meet a broad range of coupling applications. Spectrum Series can be used in many applications previously reserved for stainless steel couplings.

Features

- Excellent Chemical Compatibility
- Standard Acetal/SS Material with PVDF/SS and PVDF/PEEK™ options subject to quote
- High Flow Capacity
- Easy Push-To-Connect Operation
- Available Valved and Unvalved
- Flexible Modular Design
- Four Point 360° Locking Mechanism
- Panel Mounting Option

Applications:

- Chemical processing
- Automation equipment
- Semi-conductor industry
- Food processing

Spectrum™ Series Specifications					
	Acetal/SS (standard material) (black with black sleeve)		*PVDF/SS (translucent with white sleeve)		*PVDF/PEEK™ (translucent)
Body Size	1/8	3/8	1/8	3/8	3/8
Pressure Range	0-145 psi (0-10 bar)	0-145 psi (0-10 bar)	0-115 psi (0-8 bar)	0-115 psi (0-8 bar)	15-115 psi (0-8 bar)
Temperature Range	0° F to 180° F (-20° C to +80° C)	0° F to 180° F (-20° C to +80° C)	0° F to 250° F (-20° C to +120° C)	0° F to 250° F (-20° C to +120° C)	0° F to 250° F (-20° C to +120° C)
Rated Flow	1.5 GPM (5.6 lpm)	4.5 GPM (17 lpm)	1.5 GPM (5.6 lpm)	4.5 GPM (17 lpm)	4.5 GPM (17 lpm)
Body Material	Acetal	Acetal	PVDF	PVDF	PVDF
Spring Material	316 SS	316 SS	316 SS	316 SS	PEEK™
Seal Material	Nitrile	Nitrile	Fluorocarbon	Fluorocarbon	Fluorocarbon

*PVDF material options are subject to quote from the division

Performance

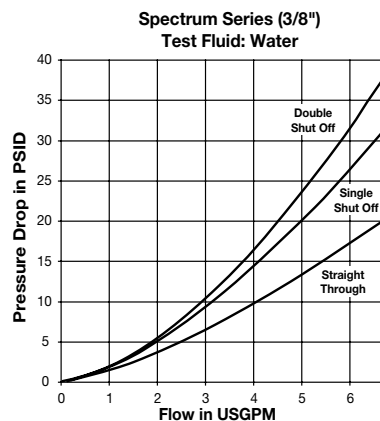
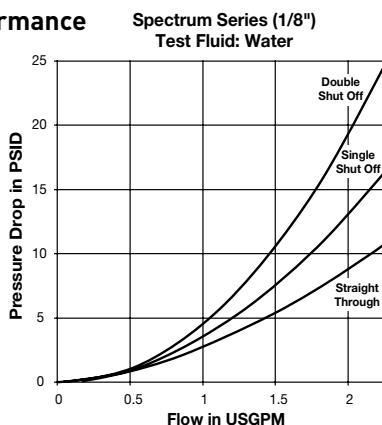

How To Order

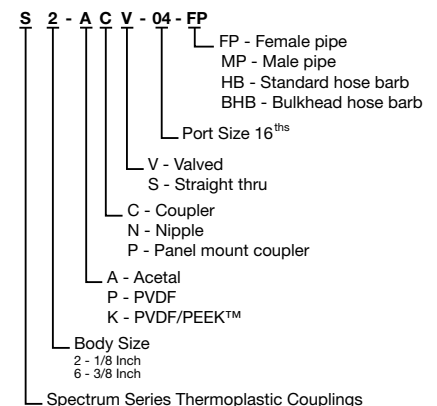

Note: Not all combinations are standard. Please contact QCD for availability, price and delivery.

Couplers- Valved, Female Pipe



Body Size	Acetal Part Number	Port NPT	Overall Length	Largest Diameter	Wrench Flats
1/8	S2-ACV-04-FP	1/4-18	2.34	.82	.67
3/8	S6-ACV-04-FP	1/4-18	2.63	1.02	.82
3/8	S6-ACV-06-FP	3/8-18	2.63	1.02	.82

Couplers- Valved, Male Pipe



Body Size	Acetal Part Number	Port NPT	Overall Length	Largest Diameter	Wrench Flats
1/8	S2-ACV-04-MP	1/4-18	2.15	.82	.67
3/8	S6-ACV-04-MP	1/4-18	2.90	1.02	.82
3/8	S6-ACV-06-MP	3/8-18	2.77	1.02	.82

Couplers- Valved, Hose Barb



Body Size	Acetal Part Number	Hose I.D.	Overall Length	Largest Diameter	Wrench Flats
1/8	S2-ACV-03-HB	3/16 (4 mm)	2.34	.82	.67
1/8	S2-ACV-04-HB	1/4 (6 mm)	2.34	.82	.67
3/8	S6-ACV-04-HB	1/4 (6 mm)	3.19	1.02	.82
3/8	S6-ACV-06-HB	3/8 (9 mm)	3.19	1.02	.82

Couplers- Valved, Bulkhead Hose Barb



Body Size	Acetal Part Number	Hose I.D.	Overall Length	Largest Diameter	Wrench Flats	Bulkhead Wrench Flats	Bulkhead Hole Diameter
1/8	S2-ACV-03-BHB	3/16 (4 mm)	2.89	.82	.67	.67	.50

Panel Mount Couplers- Valved, Female Pipe



Body Size	Acetal Part Number	Port NPT	Overall Length	Largest Diameter	Wrench Flats	Bulkhead Wrench Flats	Bulkhead Hole Diameter
1/8	S2-APV-04-FP	1/4-18	2.16	1.10	.67	1.06	1.00

Panel Mount Couplers- Valved, Hose Barb



Body Size	Acetal Part Number	Hose I.D.	Overall Length	Largest Diameter	Wrench Flats	Bulkhead Wrench Flats	Bulkhead Hole Diameter
1/8	S2-APV-04-HB	1/4 (6 mm)	2.34	1.10	.67	1.06	1.00

Nipples- Unvalved, Female Pipe



Body Size	Acetal Part Number	Port NPT	Overall Length	Largest Diameter	Wrench Flats
1/8	S2-ANS-04-FP	1/4-18	1.18	.76	.67
3/8	S6-ANS-06-FP	3/8-18	1.52	.91	.83

Nipples- Unvalved, Male Pipe



Body Size	Acetal Part Number	Port NPT	Overall Length	Largest Diameter	Wrench Flats
1/8	S2-ANS-04-MP	1/4-18	1.24	.76	.67
3/8	S6-ANS-06-MP	3/8-18	1.64	.91	.83

Nipples- Unvalved, Hose Barb



Body Size	Acetal Part Number	Hose I.D.	Overall Length	Largest Diameter
1/8	S2-ANS-03-HB	3/16 (4 mm)	1.26	.34
1/8	S2-ANS-04-HB	1/4 (6 mm)	1.26	.34
3/8	S6-ANS-04-HB	1/4 (6 mm)	1.86	.71
3/8	S6-ANS-06-HB	3/8 (9 mm)	1.87	.71

Nipples- Unvalved, Bulkhead Hose Barb



Body Size	Acetal Part Number	Hose I.D.	Overall Length	Wrench Flats	Largest Diameter	Bulkhead Wrench Flats	Bulkhead Hole Diameter
1/8	S2-ANS-03-BHB	3/16 (4 mm)	1.97	.55	.64	.55	.44
1/8	S2-ANS-04-BHB	1/4 (6 mm)	1.97	.55	.77	.67	.44

Nipples- Valved, Female Pipe



Body Size	Acetal Part Number	Port NPT	Overall Length	Largest Diameter	Wrench Flats
1/8	S2-ANV-04-FP	1/4-18	1.80	.76	.67
3/8	S6-ANV-04-FP	1/4-18	2.02	.91	.83
3/8	S6-ANV-06-FP	3/8-18	2.02	.91	.83

Nipples- Valved, Male Pipe



Body Size	Acetal Part Number	Port NPT	Overall Length	Largest Diameter	Wrench Flats
1/8	S2-ANV-04-MP	1/4-18	1.80	.76	.67
3/8	S6-ANV-04-MP	1/4-18	2.24	.91	.83
3/8	S6-ANV-06-MP	3/8-18	2.16	.91	.83

Nipples- Valved, Hose Barb



Body Size	Acetal Part Number	Hose I.D.	Overall Length	Largest Diameter	Wrench Flats
1/8	S2-ANV-03-HB	3/16 (4 mm)	1.80	.76	.67
1/8	S2-ANV-04-HB	1/4 (6 mm)	1.80	.76	.67
3/8	S6-ANV-04-HB	1/4 (6 mm)	2.59	.91	.82
3/8	S6-ANV-06-HB	3/8 (9 mm)	2.59	.91	.82

Nipples- Valved, Bulkhead Hose Barb



Body Size	Acetal Part Number	Hose I.D.	Overall Length	Largest Diameter	Wrench Flats	Bulkhead Wrench Flats	Bulkhead Hole Diameter
1/8	S2-ANV-03-BHB	3/16 (4 mm)	2.35	.76	.67	.55	.44

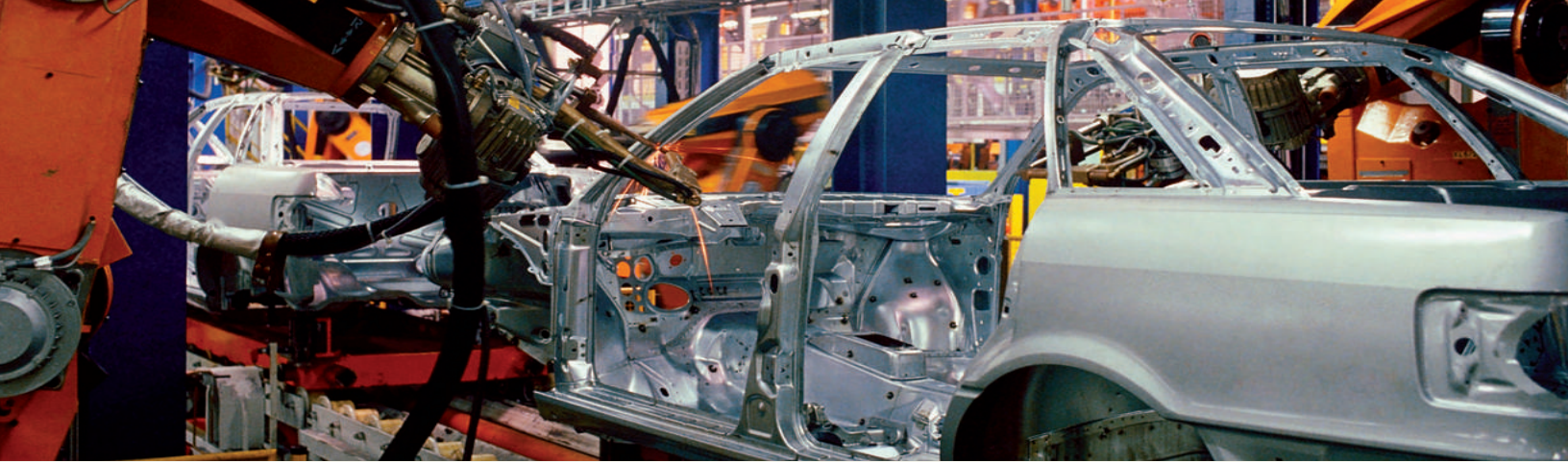

Swivels

Table of Contents

PS Series

Introduction	D-2
Seal Options	D-2
How To Order	D-4
Repair Kits	D-4
In-Line	D-5
90°	D-8

S Series

Introduction	D-13
Repair Kits	D-13
How To Order	D-14
90°	D-15



The PS Series Swivel is designed to meet today's application needs and performance requirements. Pressure capabilities up to 5000 psi, 3/8" through 1" body sizes, a variety of port options, and Chromium-6 Free plating make the PS Series Swivels ideal for an array of dynamic applications.

Features

- Hardened bearing races for extended service life.
- Full flow design minimizes pressure drop for optimum system performance.
- Sealed bearing design isolates bearing race from media and environment.
- Reduced bearing load design minimizes wear in the bearing race and extends service life.
- PTFE back-up rings support primary seal for high-pressure applications.
- Chromium-6 Free plating for maximum corrosion resistance.
- PS Series Swivels eliminate hose twist and torque that may cause premature hose failure.

PS Series Specifications

Body Size (in.)	3/8	1/2	3/4	1
Maximum Rated Pressure (psi)	5000	5000	5000	5000
Except the following port options in the noted size				
03 (Male JIC 37°)				
05 (Male SAE O-Ring Boss)				
06 (Female JIC 37°) In-Line Housing Port				
07 (Female NPSM)		4600	3000	2600
Temperature Range	-40° to 250°			

Seal Options

Nitrile

D Swivels

Performance Data

Recommended Max. Speed vs. Pressure

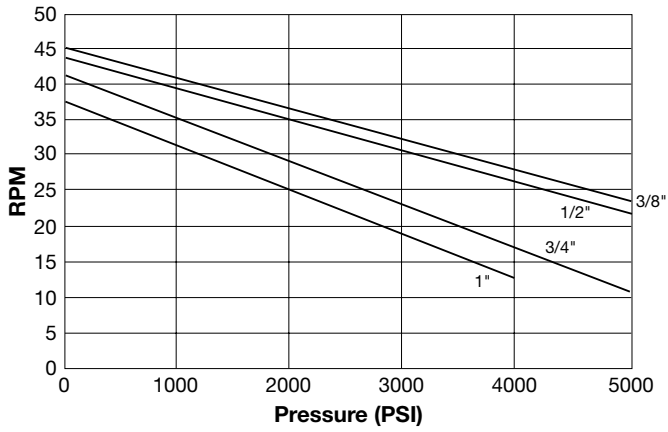

Torque vs. Pressure

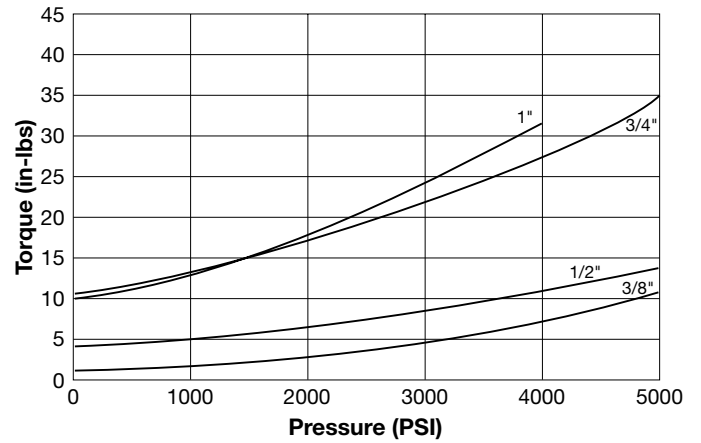

90 PS Swivel
150 SUS Oil Flow vs. Pressure Drop

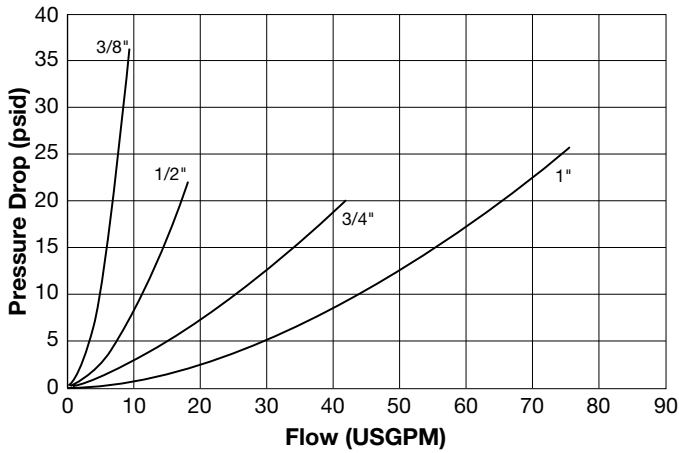

D Swivels

Swivels

PS Series

How to Order

In-Line Swivels

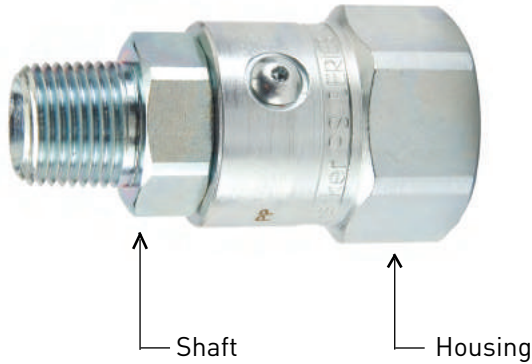

90° Swivels

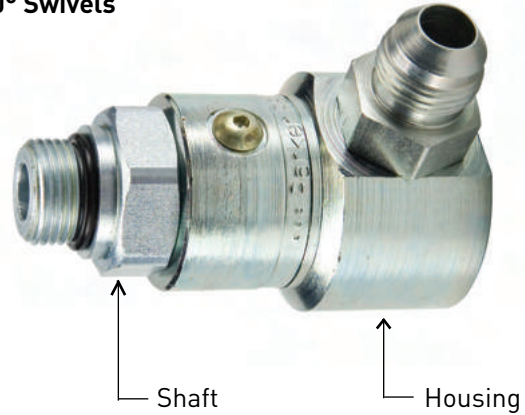

PS Part Number:

PS 16 1 01 02-16-16

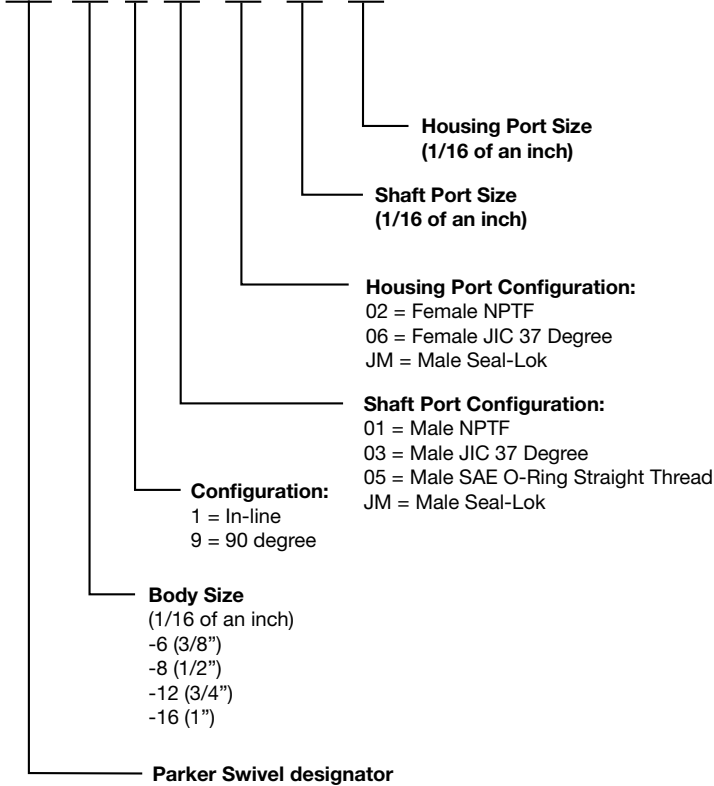

PS Part Number:

PS 16 9 05 03-16-16

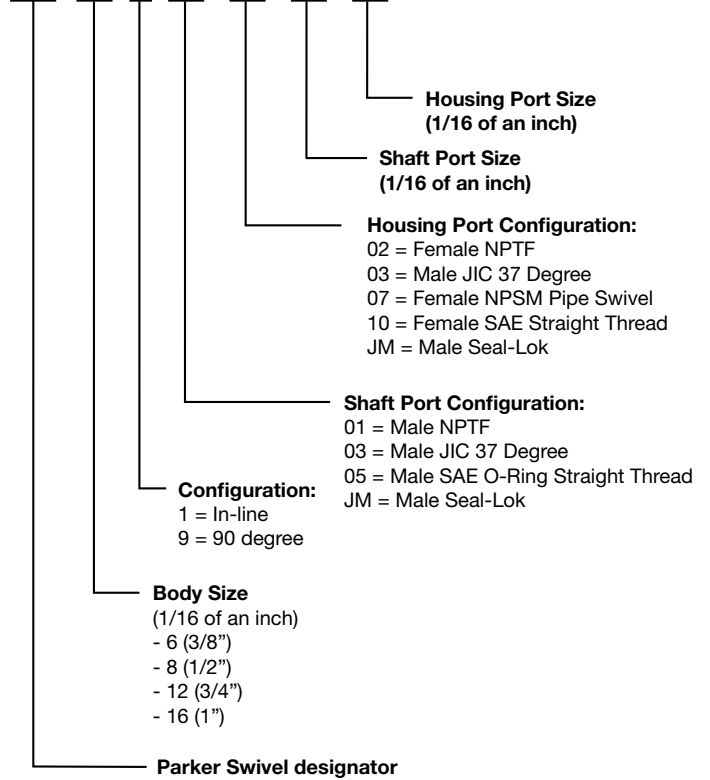

PS Series Repair Kits (In-line and 90°)

Repair Kits come complete with O-Rings, PTFE Back-Up Ring, Cap Screws, Locking Balls, Retaining Ring and grease fitting. Repair kits are suitable for both current and previous design in-line and 90° PS Series Swivels.

3/8" Swivel	1/2" Swivel	3/4" Swivel	1" Swivel
PS6-RPR	PS8-RPR	PS12-RPR	PS16-RPR
PS6Y-RPR	PS8Y-RPR	PS12Y-RPR	PS16Y-RPR
PS6A-RPR	PS8A-RPR	PS12A-RPR	PS16A-RPR
PS6W-RPR	PS8W-RPR	PS12W-RPR	PS16W-RPR

H2C-PS = Bearing Removal Pneumatic Nipple



D Swivels



Materials Of Construction

Housing:..... Carbon Steel
 Shaft:..... Carbon Steel
 Plating:..... Chromium-6 Free
 Bearing: Chrome
 O-Rings: Nitrile
 Back-Up Ring PTFE

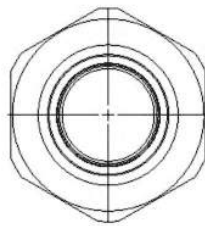
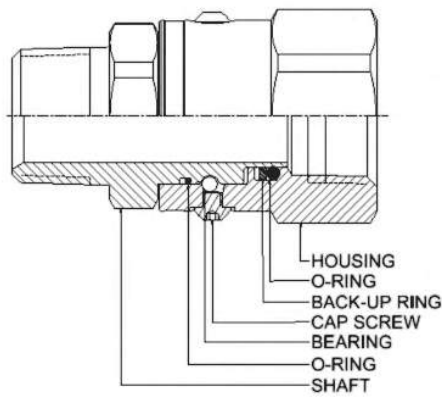

Male Pipe - Female Pipe

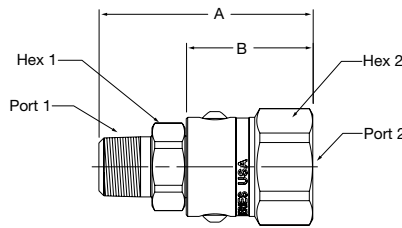

Part Number	A	B	Port 1	Port 2	Wrench Flats 1	Wrench Flats 2
PS610102-6-6	2.66" 67.5 mm	1.64" 41.7 mm	3/8-18 NPTF	3/8-18 NPTF	.88" 22.2 mm	1.31" 33.3 mm
PS810102-8-8	3.03" 76.8 mm	1.79" 45.5 mm	1/2-14 NPTF	1/2-14 NPTF	1.12" 28.6 mm	1.50" 36.5 mm
PS1210102-12-12	3.10" 78.8 mm	1.85" 47.0 mm	3/4-14 NPTF	3/4-14 NPTF	1.38" 35.0 mm	1.69" 42.9 mm
PS1610102-16-16	3.54" 89.8 mm	2.11" 53.5 mm	1-11 1/2 NPTF	1-11 1/2 NPTF	1.62" 41.3 mm	1.88" 47.6 mm

Male Pipe - Female 37° Flair

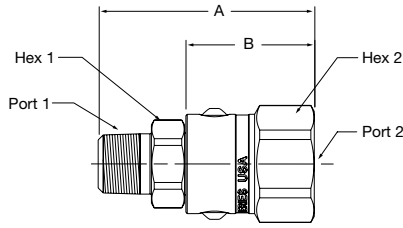

Part Number	A	B	Port 1	Port 2	Wrench Flats 1	Wrench Flats 2
PS610106-6-6	2.77" 70.3 mm	1.75" 44.5 mm	3/8-18 NPTF	9/16-18 UNF	.88" 22.2 mm	1.31" 33.3 mm
PS810106-8-8	3.05" 77.3 mm	1.81" 46.0 mm	1/2-14 NPTF	3/4-16 UNF	1.12" 28.6 mm	1.50" 36.5 mm
PS1210106-12-12	3.27" 83.2 mm	2.02" 51.3 mm	3/4-14 NPTF	1-1/16-12 UN	1.38" 35.0 mm	1.69" 42.9 mm
PS1610106-16-16	3.62" 92.0 mm	2.19" 55.6 mm	1-11 1/2 NPTF	1-5/16-12 UN	1.62" 41.3 mm	1.88" 47.6 mm

Male 37° Flare - Female Pipe

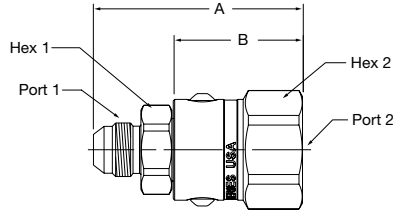

Part Number	A	B	Port 1	Port 2	Wrench Flats 1	Wrench Flats 2
PS610302-6-6	2.66" 67.5 mm	1.64" 41.7 mm	9/16-18 UNF	3/8-18 NPTF	.88" 22.2 mm	1.31" 33.3 mm
PS810302-8-8	2.89" 73.5 mm	1.79" 45.5 mm	3/4-16 UNF	1/2-14 NPTF	1.12" 28.6 mm	1.50" 36.5 mm
PS1210302-12-12	3.21" 81.5 mm	1.85" 47.0 mm	1-1/16-12 UN	3/4-14 NPTF	1.38" 35.0 mm	1.69" 42.9 mm
PS1610302-16-16	3.54" 89.8 mm	2.11" 53.5 mm	1-5/16-12 UN	1-11 1/2 NPTF	1.62" 41.3 mm	1.88" 47.6 mm

Male 37° Flare - Female 37° Flare

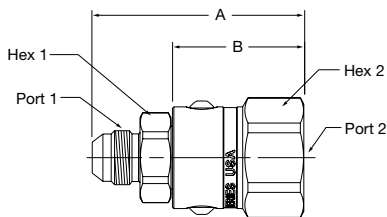

Part Number	A	B	Port 1	Port 2	Wrench Flats 1	Wrench Flats 2
PS610306-6-6	2.77" 70.3 mm	1.75" 44.5 mm	9/16-18 UNF	9/16-18 UNF	.88" 22.2 mm	1.31" 33.3 mm
PS810306-8-8	2.91" 74.0 mm	1.81" 46.0 mm	3/4-16 UNF	3/4-16 UNF	1.12" 28.6 mm	1.50" 36.5 mm
PS1210306-12-12	3.38" 85.8 mm	2.02" 51.3 mm	1-1/16-12 UN	1-1/16-12 UN	1.38" 35.0 mm	1.69" 42.9 mm
PS1610306-16-16	3.62" 92.0 mm	2.19" 55.6 mm	1-5/16-12 UN	1-5/16-12 UN	1.62" 41.3 mm	1.88" 47.6 mm

D Swivels

Male SAE O-Ring Straight Thread - Female Pipe

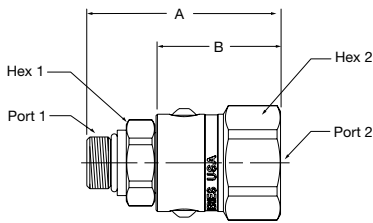

Part Number	A	B	Port 1	Port 2	Wrench Flats 1	Wrench Flats 2
PS610502-6-6	2.48" 63.0 mm	1.64" 41.7 mm	9/16-18 UNF	3/8-18 NPTF	.88" 22.2 mm	1.31" 33.3 mm
PS810502-8-8	2.79" 70.8 mm	1.79" 45.5 mm	3/4-16 UNF	1/2-14 NPTF	1.12" 28.6 mm	1.50" 36.5 mm
PS1210502-12-12	3.02" 76.7 mm	1.85" 47.0 mm	1-1/16-12 UN	3/4-14 NPTF	1.38" 35.0 mm	1.69" 42.9 mm
PS1610502-16-16	3.31" 84.1 mm	2.11" 53.5 mm	1-5/16-12 UN	1-11/2 NPTF	1.62" 41.3 mm	1.88" 47.6 mm

Male SAE O-Ring Straight Thread - Female 37° Flare

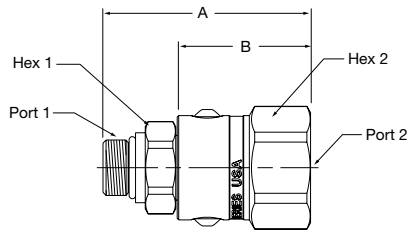

Part Number	A	B	Port 1	Port 2	Wrench Flats 1	Wrench Flats 2
PS610506-6-6	2.59" 65.8 mm	1.75" 44.5 mm	9/16-18 UNF	9/16-18 UNF	.88" 22.2 mm	1.31" 33.3 mm
PS810506-8-8	2.81" 71.3 mm	1.81" 46.0 mm	3/4-16 UNF	3/4-16 UNF	1.12" 28.6 mm	1.50" 36.5 mm
PS1210506-12-12	3.19" 81.1 mm	2.02" 51.3 mm	1-1/16-12 UN	1-1/16-12 UN	1.38" 35.0 mm	1.69" 42.9 mm
PS1610506-16-16	3.40" 86.3 mm	2.19" 55.6 mm	1-5/16-12 UN	1-5/16-12 UN	1.62" 41.3 mm	1.88" 47.6 mm

Male Seal-Lok - Male Seal-Lok

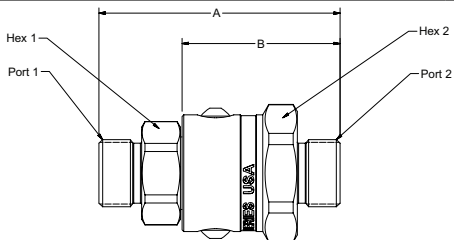

Part Number	A	B	Port 1	Port 2	Wrench Flats 1	Wrench Flats 2
PS61JMJM-6-6	2.67" 67.8 mm	1.83" 46.5 mm	11/16 - 16 UN	11/16 - 16 UN	.88" 22.2 mm	1.31" 33.3 mm
PS81JMJM-8-8	2.89" 73.4 mm	1.90" 48.3 mm	13/16 - 16 UN	13/16 - 16 UN	1.12" 28.6 mm	1.50" 38.1 mm
PS121JMJM-12-12	3.26" 82.8 mm	2.09" 53.1 mm	1-3/16 - 12 UN	1-3/16 - 12 UN	1.38" 35.0 mm	1.75" 44.4 mm
PS161JMJM-16-16	3.41" 86.6 mm	2.20" 55.9 mm	1-7/16 - 12 UN	1-7/16 - 12 UN	1.62" 41.3 mm	1.88" 47.8 mm



WARNING: This product can expose you to chemicals including Lead, which is known to the State of California to cause cancer and birth defects or other reproductive harm. For more information go to www.P65Warnings.ca.gov

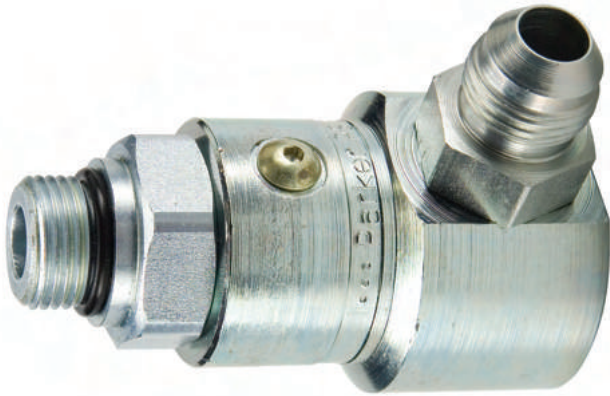

Materials Of Construction

Housing:..... Carbon Steel
 Shaft:..... Carbon Steel
 Plating:..... Chromium-6 Free
 Bearing: Chrome
 O-Rings:..... Nitrile
 Back-Up RingPTFE

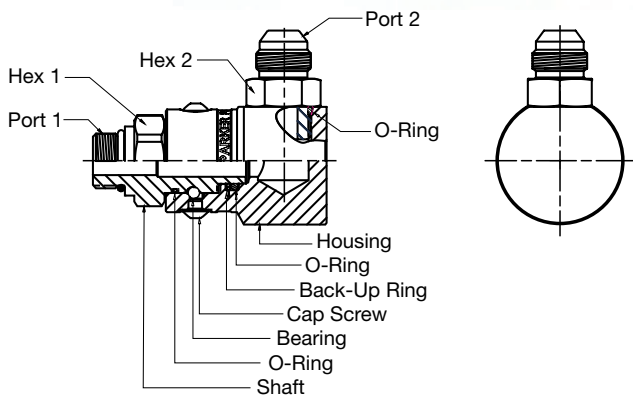

D Swivels

Male Pipe - Female Pipe

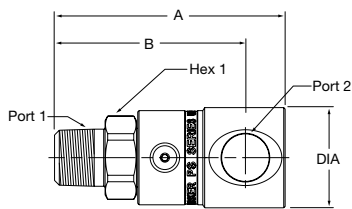

Part Number	A	B	Diameter	Port 1	Port 2	Wrench Flats 1
PS690102-6-6	3.05" 77.4 mm	2.54" 64.4 mm	1.29" 32.8 mm	3/8-18 NPTF	3/8-18 NPTF	.88" 22.2 mm
PS890102-8-8	3.43" 87.0 mm	2.84" 72.0 mm	1.49" 37.8 mm	1/2-14 NPTF	1/2-14 NPTF	1.12" 28.6 mm
PS1290102-12-12	3.66" 93.0 mm	3.00" 76.1 mm	1.76" 44.6 mm	3/4-14 NPTF	3/4-14 NPTF	1.38" 35.0 mm
PS1690102-16-16	4.41" 112.0 mm	3.54" 90.0 mm	2.16" 54.9 mm	1-11 1/2 NPTF	1-11 1/2 NPTF	1.62" 41.3 mm

Male Pipe - Male 37° Flare

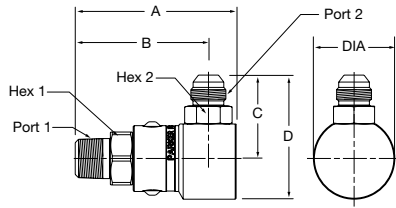

Part Number	A	B	C	D	Diameter	Port 1	Port 2	Wrench Flats 1	Wrench Flats 2
PS690103-6-6	3.05" 77.4 mm	2.54" 64.4 mm	1.44" 36.6 mm	2.09" 53.0 mm	1.29" 32.8 mm	3/8-18 NPTF	9/16-18 UNF	.88" 22.2 mm	.69" 17.5 mm
PS890103-8-8	3.43" 87.0 mm	2.84" 72.0 mm	1.78" 45.1 mm	2.64" 67.1 mm	1.73" 44.0 mm	1/2-14 NPTF	3/4-16 UNF	1.12" 28.6 mm	.88" 22.2 mm
PS1290103-12-12	3.66" 93.0 mm	3.00" 76.1 mm	2.24" 56.9 mm	3.86" 85.3 mm	2.17" 55.2 mm	3/4-14 NPTF	1-1/16-12 UN	1.38" 35.0 mm	1.25" 31.8 mm
PS1690103-16-16	4.41" 112.0 mm	3.54" 90.0 mm	2.42" 61.3 mm	3.66" 92.9 mm	2.48" 63.0 mm	1-11 1/2 NPTF	1-5/16-12 UN	1.62" 41.3 mm	1.50" 38.1 mm

Male Pipe - Female NPSM Pipe Swivel

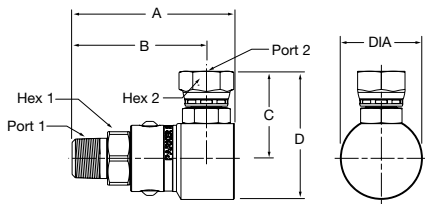

Part Number	A	B	C	D	Diameter	Port 1	Port 2	Wrench Flats 1	Wrench Flats 2
PS690107-6-6	3.05" 77.4 mm	2.54" 64.4 mm	1.51" 38.4 mm	2.16" 54.8 mm	1.29" 32.8 mm	3/8-18 NPTF	3/8-18 NPSM	.88" 22.2 mm	.88" 22.2 mm
PS890107-8-8	3.43" 87.0 mm	2.84" 72.0 mm	1.86" 47.2 mm	2.72" 69.2 mm	1.73" 44.0 mm	1/2-14 NPTF	1/2-14 NPSM	1.12" 28.6 mm	1.00" 25.4 mm
PS1290107-12-12	3.66" 93.0 mm	3.00" 76.1 mm	2.24" 56.9 mm	3.33" 84.5 mm	2.17" 55.2 mm	3/4-14 NPTF	3/4-14 NPSM	1.38" 35.0 mm	1.25" 31.8 mm
PS1690107-16-16	4.41" 112.0 mm	3.54" 90.0 mm	2.48" 63.1 mm	3.73" 94.6 mm	2.48" 63.0 mm	1-11 1/2 NPTF	1-11 1/2 NPSM	1.62" 41.3 mm	1.50" 38.1 mm

Male Pipe - Female SAE Straight Thread

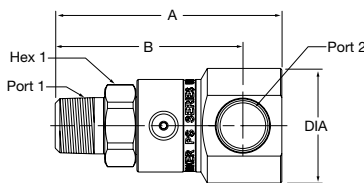

Part Number	A	B	Diameter	Port 1	Port 2	Wrench Flats 1
PS690110-6-6	3.05" 77.4 mm	2.54" 64.4 mm	1.29" 32.8 mm	3/8-18 NPTF	9/16-18 UNF	.88" 22.2 mm
PS890110-8-8	3.43" 87.0 mm	2.84" 72.0 mm	1.73" 44.0 mm	1/2-14 NPTF	3/4-16 UNF	1.12" 28.6 mm
PS1290110-12-12	3.66" 93.0 mm	3.00" 76.1 mm	2.17" 55.2 mm	3/4-14 NPTF	1-1/16-12 UN	1.38" 35.0 mm
PS1690110-16-16	4.41" 112.0 mm	3.54" 90.0 mm	2.48" 63.0 mm	1-11 1/2 NPTF	1-5/16-12 UN	1.62" 41.3 mm

Male Pipe - Male Seal-Lok

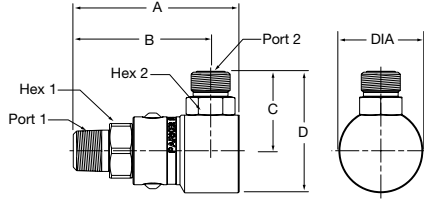

Part Number	A	B	C	D	Diameter	Port 1	Port 2	Wrench Flats 1	Wrench Flats 2
PS6901JM-6-6	3.05" 77.4 mm	2.54" 64.4 mm	1.40" 35.6 mm	2.05" 52.0 mm	1.29" 32.8 mm	3/8-18 NPTF	11/16-16 UN	.88" 22.2 mm	.69" 17.5 mm
PS8901JM-8-8	3.43" 87.0 mm	2.84" 72.0 mm	1.74" 44.1 mm	2.60" 66.1 mm	1.73" 44.0 mm	1/2-14 NPTF	13/16-16 UN	1.12" 28.6 mm	.88" 22.2 mm
PS12901JM-12-12	3.66" 93.0 mm	3.00" 76.1 mm	2.18" 55.4 mm	3.27" 83.0 mm	2.17" 55.2 mm	3/4-14 NPTF	1-3/16-12 UN	1.38" 35.0 mm	1.25" 31.8 mm
PS16901JM-16-16	4.41" 112.0 mm	3.54" 90.0 mm	2.34" 59.6 mm	3.59" 91.1 mm	2.48" 63.0 mm	1-11 1/2 NPTF	1-7/16-12 UN	1.62" 41.3 mm	1.50" 38.1 mm

Male 37° Flare - Female Pipe

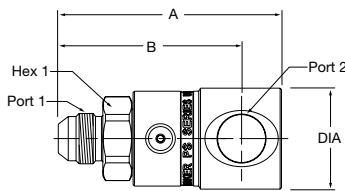

Part Number	A	B	Port 1	Port 2	Wrench Flats 1	Wrench Flats 2
PS690302-6-6	3.05" 77.4 mm	2.54" 64.4 mm	9/16-18 UNF	3/8-18 NPTF	1.29" 32.8 mm	.88" 22.2 mm
PS890302-8-8	3.29" 83.7 mm	2.70" 68.7 mm	3/4-16 UNF	1/2-14 NPTF	1.49" 37.8 mm	1.12" 28.6 mm
PS1290302-12-12	3.76" 95.6 mm	3.10" 78.8 mm	1-1/16-12 UN	3/4-14 NPTF	1.76" 44.6 mm	1.38" 35.0 mm
PS1690302-16-16	4.41" 112.0 mm	3.54" 90.0 mm	1-5/16-12 UN	1-11 1/2 NPTF	2.16" 54.9 mm	1.62" 41.3 mm

Male 37° Flare - Male 37° Flare

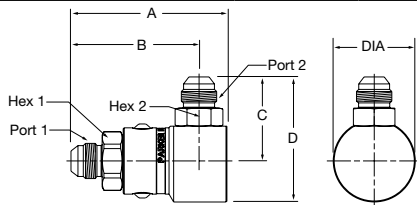

Part Number	A	B	C	D	Diameter	Port 1	Port 2	Wrench Flats 1	Wrench Flats 2
PS690303-6-6	3.05" 77.4 mm	2.54" 64.4 mm	1.44" 36.6 mm	2.09" 53.0 mm	1.29" 32.8 mm	9/16-18 UNF	9/16-18 UNF	.88" 22.2 mm	.69" 17.5 mm
PS890303-8-8	3.29" 83.7 mm	2.70" 68.7 mm	1.78" 45.1 mm	2.64" 67.1 mm	1.73" 44.0 mm	3/4-16 UNF	3/4-16 UNF	1.12" 28.6 mm	.88" 22.2 mm
PS890303-10-10	3.39" 86.2 mm	2.80" 71.2 mm	1.90" 48.4 mm	2.77" 70.4 mm	1.73" 44.0 mm	7/8-14 UNF	7/8-14 UNF	1.12" 28.6 mm	.88" 22.2 mm
PS1290303-12-12	3.76" 95.6 mm	3.10" 78.8 mm	2.24" 56.9 mm	3.86" 85.3 mm	2.17" 55.2 mm	1-1/16-12 UN	1-1/16-12 UN	1.38" 35.0 mm	1.25" 31.8 mm
PS1690303-16-16	4.41" 112.0 mm	3.54" 90.0 mm	2.42" 61.3 mm	3.66" 92.9 mm	2.48" 63.0 mm	1-5/16-12 UN	1-5/16-12 UN	1.62" 41.3 mm	1.50" 38.1 mm

D Swivels

Male 37° Flare - Female NPSM Pipe Swivel

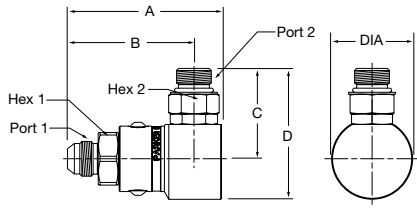

Part Number	A	B	C	D	Diameter	Port 1	Port 2	Wrench Flats 1	Wrench Flats 2
PS690307-6-6	3.05" 77.4 mm	2.54" 64.4 mm	1.51" 38.4 mm	2.16" 54.8 mm	1.29" 32.8 mm	9/16-18 UNF	3/8-18 NPSM	.88" 22.2 mm	.88" 22.2 mm
PS890307-8-8	3.29" 83.7 mm	2.70" 68.7 mm	1.86" 47.2 mm	2.72" 69.2 mm	1.73" 44.0 mm	3/4-16 UNF	1/2-14 NPSM	1.12" 28.6 mm	1.00" 25.4 mm
PS1290307-12-12	3.76" 95.6 mm	3.10" 78.8 mm	2.24" 56.9 mm	3.33" 84.5 mm	2.17" 55.2 mm	1-1/16-12 UN	3/4-14 NPSM	1.38" 35.0 mm	1.25" 31.8 mm
PS1690307-16-16	4.41" 112.0 mm	3.54" 90.0 mm	2.48" 63.1 mm	3.73" 94.6 mm	2.48" 63.0 mm	1-5/16-12 UN	1-11/2 NPSM	1.62" 41.3 mm	1.50" 38.1 mm



WARNING: This product can expose you to chemicals including Lead, which is known to the State of California to cause cancer and birth defects or other reproductive harm. For more information go to www.P65Warnings.ca.gov

Male 37° Flare - Female SAE Straight Thread

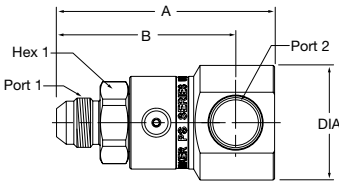

Part Number	A	B	Diameter	Port 1	Port 2	Wrench Flats
PS690310-6-6	3.05" 77.4 mm	2.54" 64.4 mm	1.29" 32.8 mm	9/16-18 UNF	9/16-18 UNF	.88" 22.2 mm
PS890310-8-8	3.29" 83.7 mm	2.70" 68.7 mm	1.73" 44.0 mm	3/4-16 UNF	3/4-16 UNF	1.12" 28.6 mm
PS1290310-12-12	3.76" 95.6 mm	3.10" 78.8 mm	2.17" 55.2 mm	1-1/16-12 UN	1-1/16-12 UN	1.38" 35.0 mm
PS1690310-16-16	4.41" 112.0 mm	3.54" 90.0 mm	2.48" 63.0 mm	1-1/16-12 UN	1-1/16-12 UN	1.62" 41.3 mm

Male SAE O-Ring Straight Thread - Female Pipe

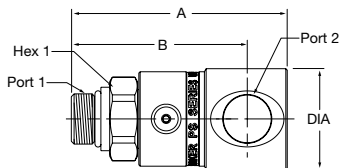

Part Number	A	B	Diameter	Port 1	Port 2	Wrench Flats
PS690502-6-6	2.87" 72.8 mm	2.36" 59.8 mm	1.29" 32.8 mm	9/16-18 UNF	3/8-18 NPTF	.88" 22.2 mm
PS890502-8-8	3.19" 80.9 mm	2.60" 65.9 mm	1.49" 37.8 mm	3/4-16 UNF	1/2-14 NPTF	1.12" 28.6 mm
PS1290502-12-12	3.58" 90.9 mm	2.92" 74.0 mm	1.76" 44.6 mm	1-1/16-12 UN	3/4-14 NPTF	1.38" 35.0 mm
PS1690502-16-16	4.18" 106.3 mm	3.32" 84.3 mm	2.16" 54.9 mm	1-5/16-12 UN	1-11/2 NPTF	1.62" 41.3 mm

Male SAE O-Ring Straight Thread - Male 37° Flare

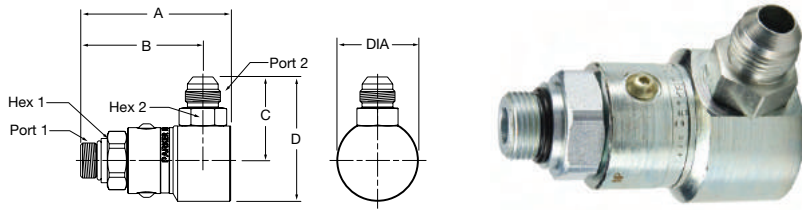

Part Number	A	B	C	D	Diameter	Port 1	Port 2	Wrench Flats 1	Wrench Flats 2
PS690503-6-6	2.87" 72.8 mm	2.36" 59.8 mm	1.44" 36.6 mm	2.09" 53.0 mm	1.29" 32.8 mm	9/16-18 UNF	9/16-18 UNF	.88" 22.2 mm	.69" 17.5 mm
PS890503-8-8	3.19" 80.9 mm	2.60" 65.9 mm	1.78" 45.1 mm	2.64" 67.1 mm	1.73" 44.0 mm	3/4-16 UNF	3/4-16 UNF	1.12" 28.6 mm	.88" 22.2 mm
PS890503-10-10	3.25" 82.5 mm	2.66" 67.5 mm	1.90" 48.4 mm	2.77" 70.4 mm	1.73" 44.0 mm	7/8-14 UNF	7/8-14 UNF	1.12" 28.6 mm	.88" 22.2 mm
PS1290503-12-12	3.58" 90.9 mm	2.92" 74.0 mm	2.24" 56.9 mm	3.86" 85.3 mm	2.17" 55.2 mm	1-1/16-12 UN	1-1/16-12 UN	1.38" 35.0 mm	1.25" 31.8 mm
PS1690503-16-16	4.18" 106.3 mm	3.32" 84.3 mm	2.42" 61.3 mm	3.66" 92.9 mm	2.48" 63.0 mm	1-5/16-12 UN	1-5/16-12 UN	1.62" 41.3 mm	1.50" 38.1 mm

Male SAE O-Ring Straight Thread - Female NPSM Pipe Swivel

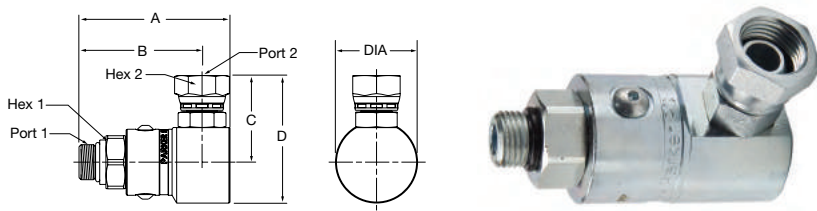

Part Number	A	B	C	D	Diameter	Port 1	Port 2	Wrench Flats 1	Wrench Flats 2
PS690507-6-6	2.87" 72.8 mm	2.36" 59.8 mm	1.51" 38.4 mm	2.16" 54.8 mm	1.29" 32.8 mm	9/16-18 UNF	3/8-18 NPSM	.88" 22.2 mm	.88" 22.2 mm
PS890507-8-8	3.19" 80.9 mm	2.60" 65.9 mm	1.86" 47.2 mm	2.72" 69.2 mm	1.73" 44.0 mm	3/4-16 UNF	1/2-14 NPSM	1.12" 28.6 mm	1.00" 25.4 mm
PS1290507-12-12	3.58" 90.9 mm	2.92" 74.0 mm	2.24" 56.9 mm	3.33" 84.5 mm	2.17" 55.2 mm	1-1/16-12 UN	3/4-14 NPSM	1.38" 35.0 mm	1.25" 31.8 mm
PS1690507-16-16	4.18" 106.3 mm	3.32" 84.3 mm	2.48" 63.1 mm	3.73" 94.6 mm	2.48" 63.0 mm	1-5/16-12 UN	1-11/2 NPSM	1.62" 41.3 mm	1.50" 38.1 mm

WARNING: This product can expose you to chemicals including Lead, which is known to the State of California to cause cancer and birth defects or other reproductive harm. For more information go to www.P65Warnings.ca.gov

Male SAE O-Ring Straight Thread - Female SAE Straight Thread

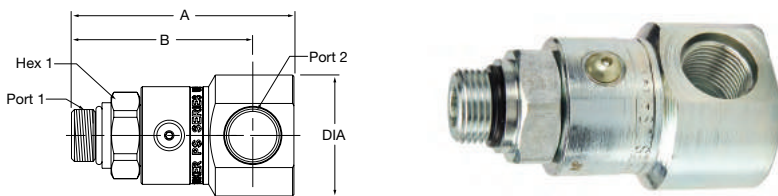

Part Number	A	B	Diameter	Port 1	Port 2	Wrench Flats
PS690510-6-6	2.87" 72.8 mm	2.36" 59.8 mm	1.29" 32.8 mm	9/16-18 UNF	9/16-18 UNF	.88" 22.2 mm
PS890510-8-8	3.19" 80.9 mm	2.60" 65.9 mm	1.73" 44.0 mm	3/4-16 UNF	3/4-16 UNF	1.12" 28.6 mm
PS1290510-12-12	3.58" 90.9 mm	2.92" 74.0 mm	2.17" 55.2 mm	1-1/16-12 UN	1-1/16-12 UN	1.38" 35.0 mm
PS1690510-16-16	4.18" 106.3 mm	3.32" 84.3 mm	2.48" 63.0 mm	1-5/16-12 UN	1-5/16-12 UN	1.62" 41.3 mm



Performance Data

**S Series Swivel (1/4", 3/8", 1/2", 3/4")
Test Fluid: Oil - 150 SUS vs. Pressure Drop**

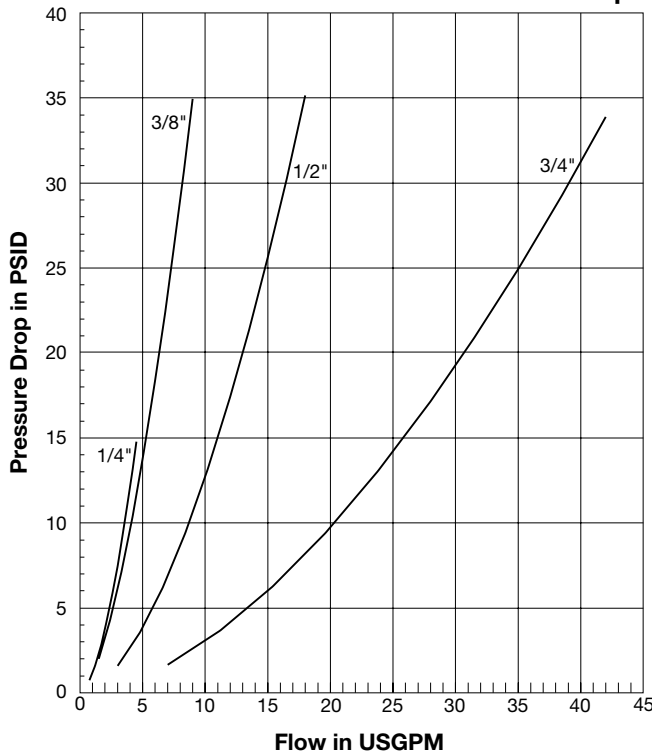

Introduction

The S Series Swivel product line complements the Quick Coupling Division's PS Series swivel line by offering a pressure balanced, compact forged body design. As a result of the pressure balanced design, the S Series Swivel does not experience a significant increase in torque as pressure rises. The housing body is forged to provide superior performance and durability in tough applications. This product is great for eliminating hose twist, torque and stress caused by the movement of the hydraulic components where side load to the swivel can be minimized.

Features

- 3000 psi working pressure rating for all sizes.
- Nitrile Seals
- Torque value does not significantly increase with pressure.
- Dust seals protect the swivel from damaging environmental contaminants.
- Field service kits are available for quick and reliable repairs.
- 360° swivel eliminates long radius bends, hose twist and stress that can cause premature hose failure.
- One piece forged housing eliminates a brazed 90° adapter connection.
- Case hardened for enhanced service life.
- Compact design to fit into tight areas.

S Series Swivel Specifications

Body Size	1/4	3/8	1/2	3/4
Maximum Rated Pressure (psi)	3000	3000	3000	3000
Temperature Range	-40° to 250° F			
Maximum RPM	10			

D Swivels

S Series Repair Kits

Repair Kits come complete with primary O-Rings, PTFE back-up rings, external and internal dust seals, retaining ring and instruction sheet.

Nitrile Seals

Size	Kit Number
-4/-6	RK-4/6N
-8/-10	RK-8N
-12	RK-12N

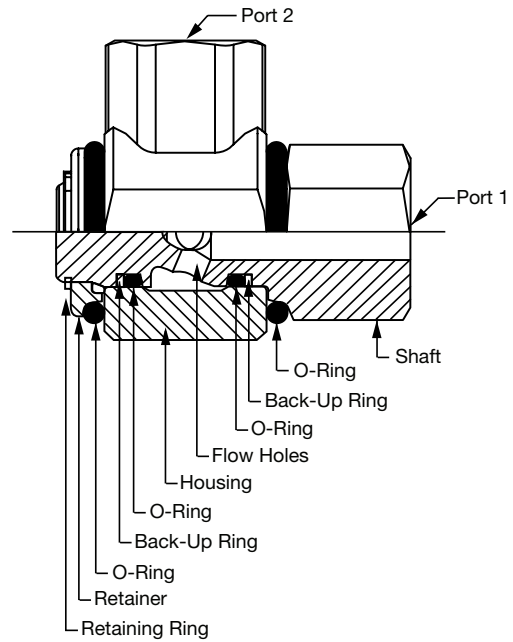

S Part Number:

S 21 02 - 8 - 8

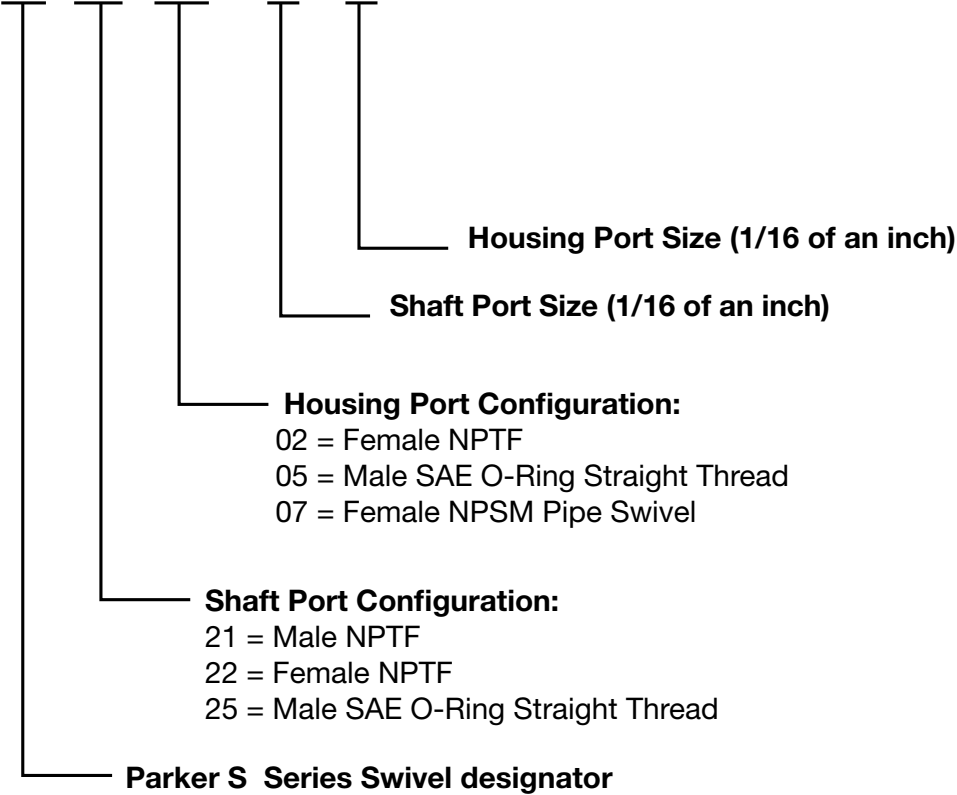

D Swivels

Male Pipe - Female Pipe

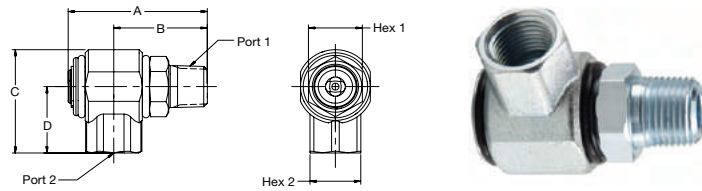

Part Number	A	B	C	D	Port 1	Port 2	Wrench Flats 1	Wrench Flats 2
S2102-4-4	2.31" 58.7 mm	1.51" 38.4 mm	1.78" 45.1 mm	1.09" 27.6 mm	1/4-18 NPTF	1/4-18 NPTF	.88" 22.2 mm	.88" 22.2 mm
S2102-6-6	2.31" 58.7 mm	1.51" 38.4 mm	1.78" 45.1 mm	1.09" 27.6 mm	3/8-18 NPTF	3/8-18 NPTF	.88" 22.2 mm	.88" 22.2 mm
S2102-8-8	2.74" 69.6 mm	1.84" 46.8 mm	2.10" 53.3 mm	1.35" 34.3 mm	1/2-14 NPTF	1/2-14 NPTF	1.06" 27.0 mm	1.00" 25.4 mm
S2102-12-12	3.35" 85.1 mm	2.12" 53.9 mm	2.39" 60.7 mm	1.50" 38.0 mm	3/4-14 NPTF	3/4-14 NPTF	1.38" 34.9 mm	1.38" 34.9 mm

Male Pipe - Female NPSM Pipe Swivel

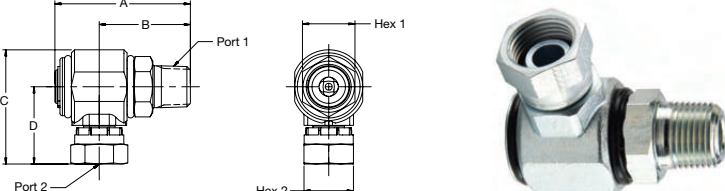

Part Number	A	B	C	D	Port 1	Port 2	Wrench Flats 1	Wrench Flats 2
S2107-4-4	2.31" 58.7 mm	1.51" 38.4 mm	2.05" 52.0 mm	1.36" 34.5 mm	1/4-18 NPTF	1/4-18 NPSM	.88" 22.2 mm	.69" 17.5 mm
S2107-6-6	2.31" 58.7 mm	1.51" 38.4 mm	2.07" 52.5 mm	1.38" 35.1 mm	3/8-18 NPTF	3/8-18 NPSM	.88" 22.2 mm	.88" 22.2 mm
S2107-8-8	2.74" 69.6 mm	1.84" 46.8 mm	2.32" 59.0 mm	1.57" 39.9 mm	1/2-14 NPTF	1/2-14 NPSM	1.06" 27.0 mm	1.00" 25.4 mm
S2107-12-12	3.35" 85.1 mm	2.12" 53.9 mm	2.74" 69.5 mm	1.85" 46.9 mm	3/4-14 NPTF	3/4-14 NPSM	1.38" 34.9 mm	1.25" 31.8 mm

Female Pipe - Female Pipe

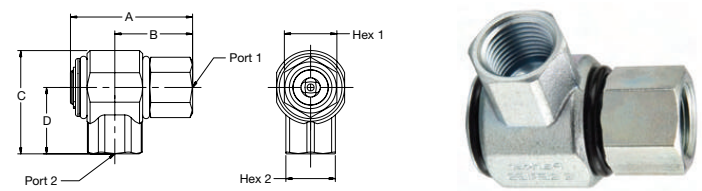

Part Number	A	B	C	D	Port 1	Port 2	Wrench Flats 1	Wrench Flats 2
S2202-4-4	2.19" 55.6 mm	1.39" 35.4 mm	1.78" 45.1 mm	1.09" 27.6 mm	1/4-18 NPTF	1/4-18 NPTF	.88" 22.2 mm	.88" 22.2 mm
S2202-6-6	2.19" 55.6 mm	1.39" 35.4 mm	1.78" 45.1 mm	1.09" 27.6 mm	3/8-18 NPTF	3/8-18 NPTF	.88" 22.2 mm	.88" 22.2 mm
S2202-8-8	2.47" 62.7 mm	1.57" 40.0 mm	2.10" 53.3 mm	1.35" 34.3 mm	1/2-14 NPTF	1/2-14 NPTF	1.06" 27.0 mm	1.00" 25.4 mm
S2202-12-12	3.15" 80.0 mm	1.92" 48.8 mm	2.39" 60.7 mm	1.50" 38.0 mm	3/4-14 NPTF	3/4-14 NPTF	1.38" 34.9 mm	1.38" 34.9 mm

Female Pipe - Female NPSM Pipe Swivel

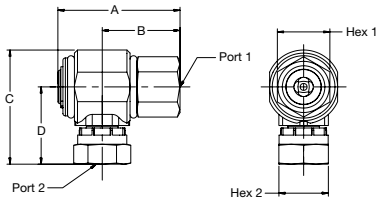

Part Number	A	B	C	D	Port 1	Port 2	Wrench Flats 1	Wrench Flats 2
S2207-4-4	2.19" 55.6 mm	1.39" 35.4 mm	2.05" 52.0 mm	1.36" 34.5 mm	1/4-18 NPTF	1/4-18 NPSM	.88" 22.2 mm	.69" 17.5 mm
S2207-6-6	2.19" 55.6 mm	1.39" 35.4 mm	2.07" 52.5 mm	1.38" 35.1 mm	3/8-18 NPTF	3/8-18 NPSM	.88" 22.2 mm	.88" 22.2 mm
S2207-8-8	2.47" 62.7 mm	1.57" 40.0 mm	2.32" 59.0 mm	1.57" 39.9 mm	1/2-14 NPTF	1/2-14 NPSM	1.06" 27.0 mm	1.00" 25.4 mm
S2207-12-12	3.15" 80.0 mm	1.92" 48.8 mm	2.74" 69.5 mm	1.85" 46.9 mm	3/4-14 NPTF	3/4-14 NPSM	1.38" 34.9 mm	1.25" 31.8 mm

Male SAE O-Ring Straight Thread - Female Pipe

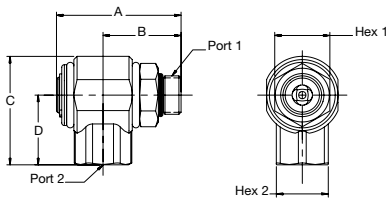

Part Number	A	B	C	D	Port 1	Port 2	Wrench Flats 1	Wrench Flats 2
S2502-6-6	2.13" 54.1 mm	1.33" 33.8 mm	1.78" 45.1 mm	1.09" 27.6 mm	9/16-18 UNF	3/8-18 NPTF	.88" 22.2 mm	.88" 22.2 mm
S2502-8-8	2.40" 61.0 mm	1.50" 38.2 mm	2.10" 53.3 mm	1.35" 34.3 mm	3/4-16 UNF	1/2-14 NPTF	1.06" 27.0 mm	1.00" 25.4 mm
S2502-12-12	3.40" 86.4 mm	2.17" 55.2 mm	2.39" 60.7 mm	1.50" 38.0 mm	1-1/16-12 UN	3/4-14 NPTF	1.38" 34.9 mm	1.38" 34.9 mm

Male SAE O-Ring Straight Thread - Female NPSM Pipe Swivel

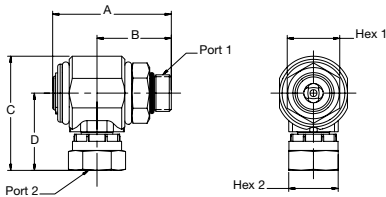

Part Number	A	B	C	D	Port 1	Port 2	Wrench Flats 1	Wrench Flats 2
S2507-6-6	2.13" 54.1 mm	1.33" 33.8 mm	2.07" 52.5 mm	1.38" 35.1 mm	9/16-18 UNF	3/8-18 NPSM	.88" 22.2 mm	.88" 22.2 mm
S2507-8-8	2.40" 61.0 mm	1.50" 38.2 mm	2.32" 59.0 mm	1.57" 39.9 mm	3/4-16 UNF	1/2-14 NPSM	1.06" 27.0 mm	1.00" 25.4 mm
S2507-12-12	3.75" 86.4 mm	2.17" 55.2 mm	2.74" 69.5 mm	1.85" 46.9 mm	1-1/16-12 UN	3/4-14 NPSM	1.38" 34.9 mm	1.25" 31.8 mm

WARNING: This product can expose you to chemicals including Lead, which is known to the State of California to cause cancer and birth defects or other reproductive harm. For more information go to www.P65Warnings.ca.gov

D Swivels

Valves

Multiple Hydraulic System Applications

Parker Check Valves are unidirectional flow control devices used primarily in hydraulic systems to eliminate potential damage caused by fluid back pressure. Offered in many configurations, Parker can satisfy most hydraulic system applications. Parker's in-line style check valves are available in a variety of sizes, pressure ratings, flow capacities and crack pressures.

H1, HM1 and PV Series Pressure / Vacuum Relief Valves are used to create and maintain a positive pressure in hydraulic tanks and reservoirs. These pressurized reservoir valves provide the following benefits:

- Prevents pump cavitation by assuring a positive supply of oil at the pump inlet
- Minimizes the tank breathing of outside, moist, contaminated air
- Filters all incoming air

As oil is drawn from the reservoir and pumped to the circuit, a vacuum is created in the reservoir. The vacuum relief valve opens to allow filtered air to enter. As oil is pumped back into the reservoir, air pressure builds. Additionally, as the oil heats, the pressure inside the reservoir increases. When the pressure exceeds the relief valve setting, the excess pressure is vented to atmosphere. Normally, the pressure will fluctuate between zero and the pressure relief setting without opening either valve. This can significantly reduce the breathing of outside air and minimize the chance for moisture and contamination to enter.

TH Series Thermal Bypass Valves ensure efficient equipment operation at any temperature. These valves are ideally suited for hydrostatic drive circuits which require fast warm-up, controlled fluid temperatures and low return line back pressure. When installed in a return line of a hydraulic circuit that utilizes an oil cooler, this valve will modulate fluid temperature by either shifting return line flow through the cooler, or bypassing directly to the reservoir. An integral pressure relief function automatically releases excess pressure to the reservoir if the cooler becomes restricted and the inlet pressure becomes excessive.



Table of Contents

Introduction	E-1
Check Valves	
Selection Guide & General	
Technical Information	E-3
DT Series	E-4
Ordering Information	E-8
CV Series	E-9
Ordering Information	E-11
DC Series	E-12
Ordering Information	E-13
CPIFF Series (soft seat)	E-14
S6C Series (soft seat)	E-15
3C Series (soft seat)	E-15
2600 Series (swing type)	E-17
Pressure/Vacuum Relief Valves	
H1 & HM1 Series	E-18
Ordering Information	E-18
PV Series	E-19
Ordering Information	E-19
Thermal Bypass Valves	
TH Series	E-20
Ordering Information	E-21



Parker's Check Valves have several unique features that insure years of trouble-free operation.

Selection Guide					
Series	Body Size	Material	Type	Rated Pressure (psi)	Crack Pressure Range (psi)
CV Series	1/4 - 1"	Steel	Metal to Metal Seal	3000	5-130
DT Series	1/4 - 1 1/4"			2500-5000	5-200
DC Series	1/4 - 2"			3000	5-100
CPIFF Series	1/4 - 1"	Steel	Soft Seat	5000	5-65
3C Series	1 1/4 - 2"	Steel		3000	5-65
S6C Series	1/4 - 1"	316 Stainless Steel		6000	5-65

Crack Pressure

Crack pressure refers to the amount of fluid pressure in the free flow direction required to move the poppet off the seat. The normal crack pressure setting is 5 PSI; however, other crack pressures are available to allow the check valve to perform special circuit functions, or operate under unique conditions.

Check valves are not field repairable or adjustable. Crack pressure settings are made at the factory only.

Applications

Typical hydraulic circuit, the check valve is used to protect the pump by preventing pressure from returning to the outlet port of the pump.

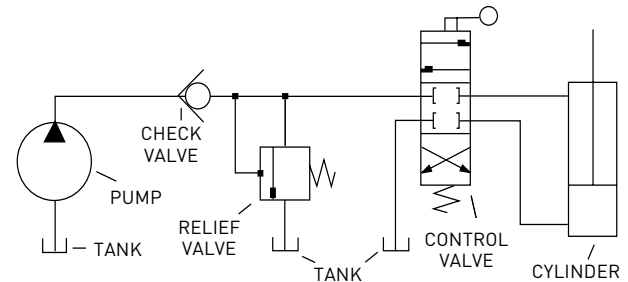
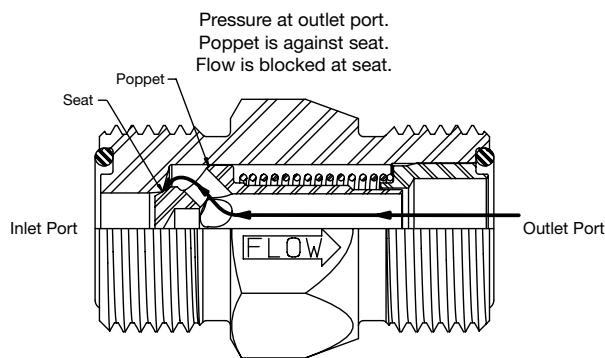
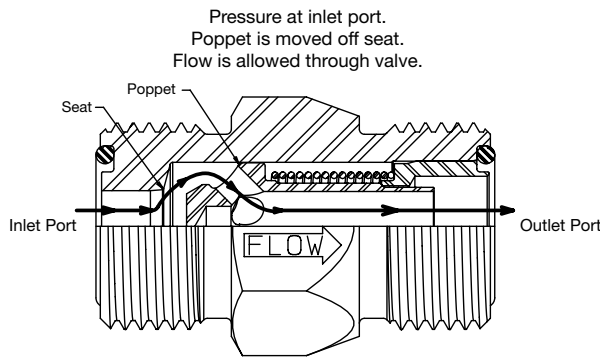

The graphic symbol for a check-valve is:

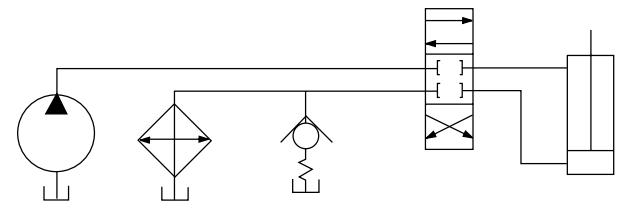

Oil cooler bypass circuit. If return line pressure becomes excessive due to resistance through oil cooler (such as startup in cold weather). Check valve opens and allows oil to bypass the cooler and flow to the tank.



Parker DT Series Check Valves Offer the Features of a Compact Body Size, and up to 5000 psi Maximum Operating Pressure.

The DT Series check valves utilize the dependable, internal design features found in Parker check valves, but with the added benefit and convenience of compact design. Sizes are available from 1/4" to 1-1/4" with six different Fitting Styles. The DT Series expands Parker's high quality product line of versatile and efficient check valves.

Features

- Compact Design. Easy to plumb into tight circuits.
- All steel construction. No internal gaskets or seals to wear out.
- One-piece body eliminates threads and seals that may be potential leakage points.
- Smooth flow stream. Poppet spring is isolated from flow stream.
- Variety of end fittings.
- Optional crack pressures available from 1 to 200 PSI.
- Chromium-6 Free plated exterior finish.
- Nitrile O-Ring included on MO and MS fittings.
- Captive O-Ring Groove is standard on MS end fittings.

Specifications

The DT Series check valves have a Maximum Operating Pressure of 2500-5000 PSI. Standard crack pressures are 1, 5, and 65 PSI depending on the port size and configuration. Other crack pressures up to 200 PSI in 5 PSI increments are available upon request.

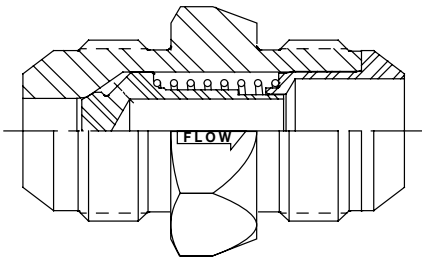

DT-MFMF

Male Flare 37° JIC Inlet to Male Flare 37° JIC Outlet

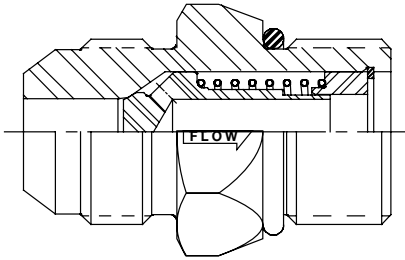

DT-MFMO

Male Flare 37° JIC Inlet to Male O-Ring Boss Outlet

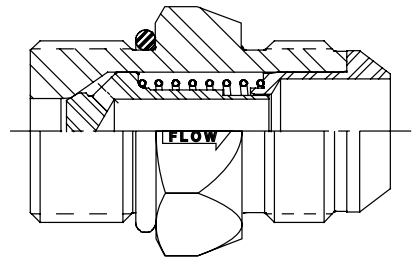

DT-MOMF

Male O-Ring Boss Inlet to Male Flare 37° JIC Outlet

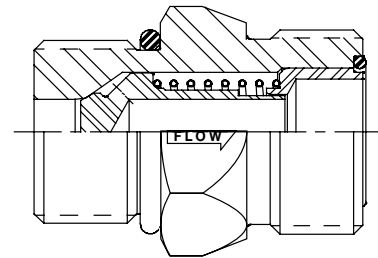

DT-MOMS

Male O-Ring Boss Inlet to Male Seal-Lok® Outlet

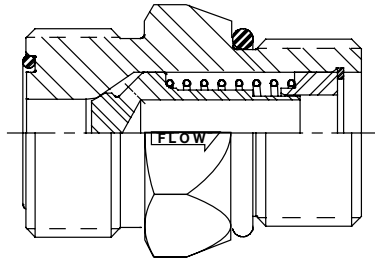

DT-MSMO

Male Seal-Lok® Inlet to Male O-Ring Boss Outlet

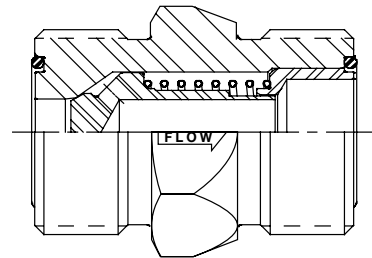

DT-MSMS

Male Seal-Lok® Inlet to Male Seal-Lok® Outlet

DT-MFMF Male Flare 37° JIC Inlet to Male Flare 37° JIC Outlet

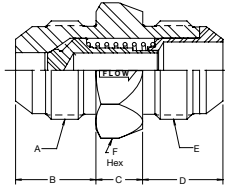

Valve Size	Part Number	Inlet Port Thread	Dimensions (in.)				Outlet Port Thread	Wrench Flats	** Std Crack Pressure (psi)
		A	B	C	D	E	F		
3/8	DT-370-MFMF-**	9/16-18 UNF	.56	.44	.56	9/16-18 UNF	.75	1, 5, 65	
1/2	DT-500-MFMF-**	3/4-16 UNF	.66	.50	.66	3/4-16 UNF	.88	5, 65	
5/8	DT-620-MFMF-**	7/8-14 UNF	.76	.50	.76	7/8-14 UNF	1.06	5	
3/4	DT-750-MFMF-**	1-1/16 - 12 UN	.86	.50	.86	1-1/16-12 UN	1.25	1, 5, 65	
1	DT-1000-MFMF-**	1-5/16 - 12 UN	.91	.62	.91	1-5/16-12 UN	1.50	5, 65	
1-1/4	DT-1250-MFMF-**	1-5/8 - 12 UN	.96	1.06	.96	1-5/8-12 UN	1.88	1, 5	

DT-MFMO Male Flare 37° JIC Inlet to Male O-Ring Boss Outlet

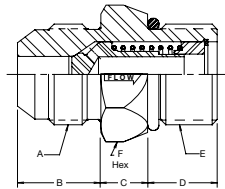

Valve Size	Part Number	Inlet Port Thread	Dimensions (in.)				Outlet Port Thread	Wrench Flats	** Std Crack Pressure (psi)
		A	B	C	D	E	F		
3/8	DT-370-MFMO-**	9/16-18 UNF	.56	.44	.47	9/16-18 UNF	.75	1, 5, 65	
1/2	DT-500-MFMO-**	3/4-16 UNF	.66	.50	.55	3/4-16 UNF	.88	5, 65	
5/8	DT-620-MFMO-**	7/8-14 UNF	.76	.50	.63	7/8-14 UNF	1.06	5	
3/4	DT-750-MFMO-**	1-1/16 - 12 UN	.86	.50	.73	1-1/16 - 12 UN	1.25	1, 5, 65	
1	DT-1000-MFMO-**	1-5/16 - 12 UN	.91	.62	.73	1-5/16 - 12 UN	1.50	5, 65	
1-1/4	DT-1250-MFMO-**	1-5/8 - 12 UN	.96	1.06	.73	1-5/8 - 12 UN	1.88	1, 5	



WARNING: This product can expose you to chemicals including Lead, which is known to the State of California to cause cancer and birth defects or other reproductive harm. For more information go to www.P65Warnings.ca.gov

DT-MOMF Male O-Ring Boss Inlet to Male Flare 37° JIC Outlet

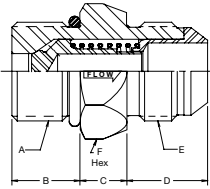

Valve Size	Part Number	Inlet Port Thread	Dimensions (in.)				Outlet Port Thread	Wrench Flats	** Std Crack Pressure (psi)
		A	B	C	D	E	F		
1/4	DT-250-MOMF-**	7/16-20 UNF	.43	.44	.55	7/16-20 UNF	.62	5	
3/8	DT-370-MOMF-**	9/16-18 UNF	.47	.44	.56	9/16-18 UNF	.75	1, 5, 65	
1/2	DT-500-MOMF-**	3/4-16 UNF	.55	.50	.66	3/4-16 UNF	.88	5, 65	
5/8	DT-620-MOMF-**	7/8-14 UNF	.63	.50	.76	7/8-14 UNF	1.06	5	
3/4	DT-750-MOMF-**	1-1/16 - 12 UN	.73	.50	.86	1-1/16 - 12 UN	1.25	1, 5, 65	
1	DT-1000-MOMF-**	1-5/16 - 12 UN	.73	.62	.91	1-5/16 - 12 UN	1.50	5, 65	
1-1/4	DT-1250-MOMF-**	1-5/8 - 12 UN	.73	1.06	.96	1-5/8 - 12 UN	1.88	1, 5	

DT-MOMS Male O-Ring Boss Inlet to Male Seal-Lok® Outlet

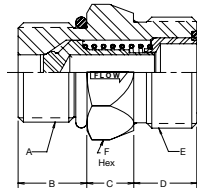

Valve Size	Part Number	Inlet Port Thread	Dimensions (in.)				Outlet Port Thread	Wrench Flats	** Std Crack Pressure (psi)
		A	B	C	D	E	F		
1/4	DT-250-MOMS-**	7/16-20 UNF	.43	.45	.39	9/16-18 UNF	.62	5	
3/8	DT-370-MOMS-**	9/16-18 UNF	.47	.44	.44	11/16-16 UN	.75	1, 5, 65	
1/2	DT-500-MOMS-**	3/4-16 UNF	.55	.50	.51	13/16-16 UN	.88	5, 65	
5/8	DT-620-MOMS-**	7/8-14 UNF	.63	.50	.62	1-14 UNS	1.06	5	
3/4	DT-750-MOMS-**	1-1/16 - 12 UN	.73	.50	.68	1-3/16 - 12 UN	1.25	1, 5, 65	
1	DT-1000-MOMS-**	1-5/16 - 12 UN	.73	.62	.70	1-7/16 - 12 UN	1.50	5, 65	
1-1/4	DT-1250-MOMS-**	1-5/8 - 12 UN	.73	1.06	.70	1-11/16 - 12 UN	1.88	1, 5	

E Valves



WARNING: This product can expose you to chemicals including Lead, which is known to the State of California to cause cancer and birth defects or other reproductive harm. For more information go to www.P65Warnings.ca.gov

DT-MSMO Male Seal-Lok® Inlet to Male O-Ring Boss Outlet

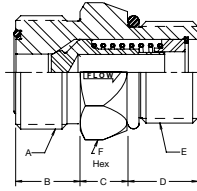

Valve Size	Part Number	Inlet Port Thread	Dimensions (in.)			Outlet Port Thread	Wrench Flats	** Std Crack Pressure (psi)
			A	B	C			
3/8	DT-370-MSMO-**	11/16-16 UN	.44	.44	.47	9/16-18 UNF	.75	1, 5, 65
1/2	DT-500-MSMO-**	13/16-16 UN	.51	.50	.55	3/4-16 UNF	.88	5, 65
5/8	DT-620-MSMO-**	1-14 UNS	.62	.49	.63	7/8-14 UNF	1.06	5
3/4	DT-750-MSMO-**	1-3/16 - 12 UN	.68	.50	.73	1-1/16 - 12 UN	1.25	1, 5, 65
1	DT-1000-MSMO-**	1-7/16 - 12 UN	.70	.62	.73	1-5/16 - 12 UN	1.50	5, 65
1-1/4	DT-1250-MSMO-**	1-11/16 - 12 UN	.70	1.06	.73	1-5/8 - 12 UN	1.88	1, 5

DT-MSMS Male Seal-Lok® Inlet to Male Seal-Lok® Outlet

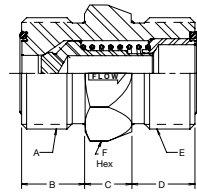

Valve Size	Part Number	Inlet Port Thread	Dimensions (in.)			Outlet Port Thread	Wrench Flats	** Std Crack Pressure (psi)
			A	B	C			
3/8	DT-370-MSMS-**	11/16-16 UN	.44	.44	.44	11/16-16 UN	.75	1, 5, 65
1/2	DT-500-MSMS-**	13/16-16 UN	.51	.50	.51	13/16-16 UN	.88	5, 65
5/8	DT-620-MSMS-**	1-14 UNS	.62	.50	.62	1-14 UNS	1.06	5
3/4	DT-750-MSMS-**	1-3/16 - 12 UN	.68	.50	.68	1-3/16 - 12 UN	1.25	1, 5, 65
1	DT-1000-MSMS-**	1-7/16 - 12 UN	.70	.62	.70	1-7/16 - 12 UN	1.50	5, 65
1-1/4	DT-1250-MSMS-**	1-11/16 - 12 UN	.70	1.06	.70	1-11/16 - 12 UN	1.88	1, 5



WARNING: This product can expose you to chemicals including Lead, which is known to the State of California to cause cancer and birth defects or other reproductive harm. For more information go to www.P65Warnings.ca.gov

Flow Data

DT Series (1/4" & 3/8")
Test Fluid: Oil - 200 SUS

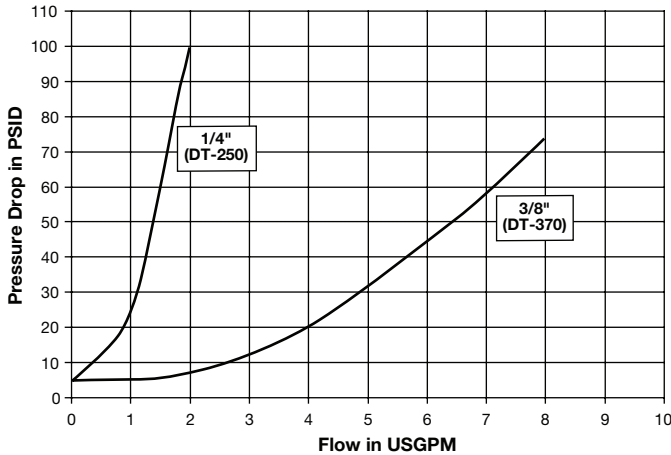

DT Series (1/2", 5/8" & 3/4")
Test Fluid: Oil - 200 SUS

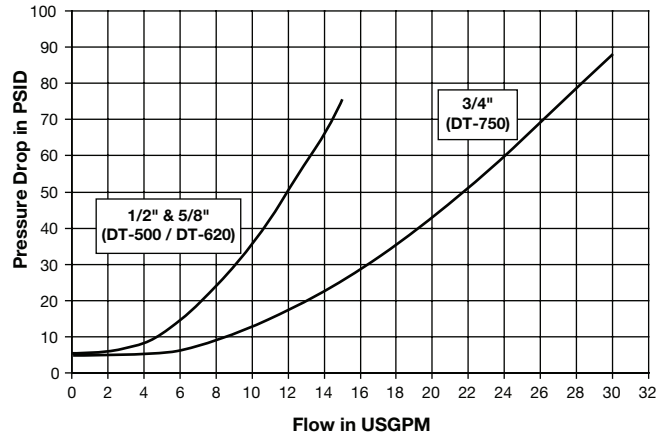

DT Series (1" & 1-1/4")
Test Fluid: Oil - 200 SUS

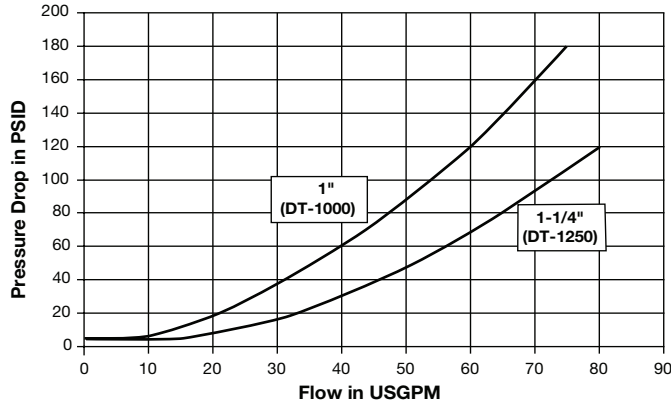

Specifications

Series	Body Size (in.)	Material	Rated Pressure (psi)	Crack Pressure Range (psi)
DT Series	1/4 - 1 1/4	Steel	2500-5000	5-200

DT Series Pressure Table (psi)

Body Size	Max Rated Pressure	MF (Male JIC 37)	M0 (SAE O-Ring Boss)	MS (Male Seal-Lok)
1/4	5000	5000	5000	5000
3/8	5000	5000	5000	5000
1/2	5000	4500	5000	5000
5/8	5000	3500	5000	5000
3/4	5000	3500	5000	5000
1	5000	3000	5000	5000
1 1/4	4000	2500	4000	4000

Ordering Information

DT - * * * - * * * * - * *

SERIES	SIZE	FITTING STYLE
250	1/4"	MFMF - Male Flare Inlet to Male Flare Outlet
370	3/8"	MFMO - Male Flare Inlet to Male O-Ring Boss Outlet
500	1/2"	MOMF - Male O-Ring Boss Inlet to Male Flare Outlet
620	5/8"	MOMS - Male O-Ring Boss Inlet to Male Face Seal Outlet
750	3/4"	MSMO - Male Face Seal Inlet to Male O-Ring Boss Outlet
1000	1"	MSMS - Male Face Seal Inlet to Male Face Seal Outlet
1250	1-1/4"	

CRACK PRESSURE
 1 = 1 PSI
 5 = 5 PSI
 65 = 65 PSI
 Other Crack Pressures up to 200 PSI in 5 PSI increments are available. Contact the Division for price and delivery on non-standard crack pressures

DT Series Installation Assembly Torque (ft-lbs)

Body Size	MF (Male JIC 37)	M0 (SAE O-Ring Boss)	MS (Male Seal-Lok)
1/4	Refer to Parker TFD Catalog 4300 for torque recommendation	13.3 +10% / -0%	Refer to Parker TFD Catalog 4300 for torque recommendation
3/8		22.1 +10% / -0%	
1/2		62.6 +10% / -0%	
5/8		84.8 +10% / -0%	
3/4		125.3 +10% / -0%	
1		199 +10% / -0%	
1 1/4		210 +10% / -0%	



CV Series Check Valves Offer Low Pressure Drop and High Flow.

Parker's CV Series check valves are a rugged built and versatile product designed to protect hydraulic systems from fluid back pressure. The CV Series compliments the DT Series by adding the feature of modular design. The larger body results in less pressure drop and increased performance. The CV Series are in-line unidirectional valves, available in sizes 1/4" to 1", with a pressure rating of up to 3000 PSI, and flow capacities to 100 GPM. Standard spring crack pressures are 5 and 65 PSI. Other crack pressures available upon request.

Features

1. Nitrile O-ring is standard in the body assembly. Note port O-rings are included on the MO and MS ports.
2. All-steel construction
3. Valve seats resist damage from shocks, surges and contamination.
4. Poppet has an oil retention groove that lubricates the bore and eliminates galling.
5. Poppet spring is isolated from the liquid flow stream, minimizing turbulence.
6. Poppet is heat treated to help prevent damage from shocks, surges and galling.
7. Close tolerance fit between poppet and poppet retainer creates a cushion that protects valve from surge shock damage.
8. Optional crack pressures available upon request.

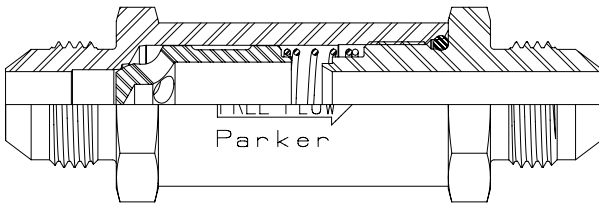
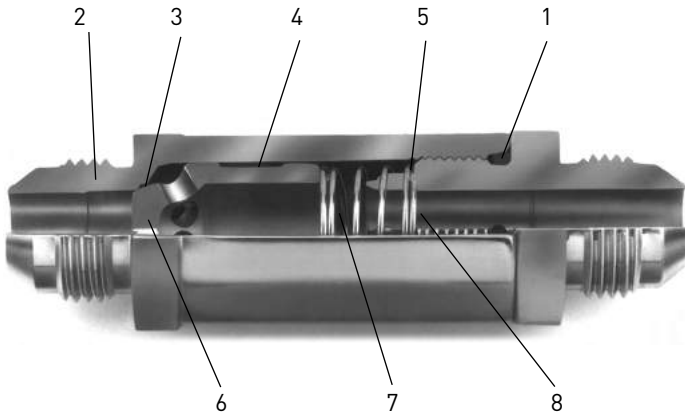

CV-MFMF
Male Flare 37° JIC Inlet to Male Flare 37° JIC Outlet

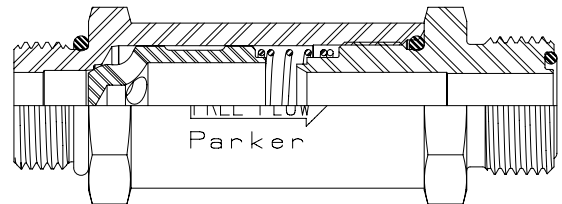

CV-MOMS
Male O-Ring Boss Inlet to Male Seal-Lok® Outlet

NOTE: Contact QCD for additional port end options.

CV-MFMF Male Flare 37° JIC Inlet to Male Flare 37° JIC Outlet

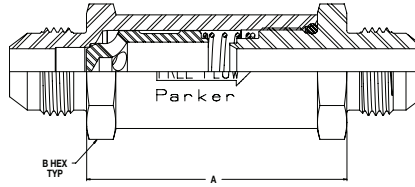

Valve Size	Part Number	Inlet Port Thread	Dimensions (in.)		Outlet Port Thread	** Std Crack Pressure (psi)	Max Operating Pressure (psi)
			Length	Wrench Flats			
			A	B			
1/4	CV-250-MFMF-**	7/16-20 UNF	1.53	.68	7/16-20 UNF	5, 65	3000
3/8	CV-370-MFMF-**	9/16-18 UNF	1.75	.81	9/16-18 UNF	5, 65	3000
1/2	CV-500-MFMF-**	3/4-16 UNF	2.22	1.00	3/4-16 UNF	5, 65	3000
5/8	CV-620-MFMF-**	7/8-14 UNF	2.41	1.12	7/8-14 UNF	5, 65	3000
3/4	CV-750-MFMF-**	1-1/16-12 UN	2.75	1.38	1-1/16-12 UN	5, 65	3000
1	CV-1000-MFMF-**	1-5/16-12 UN	3.31	1.62	1-5/16-12 UN	5, 65	3000

CV-MOMS Male O-Ring Boss Inlet to Male Seal-Lok® Outlet

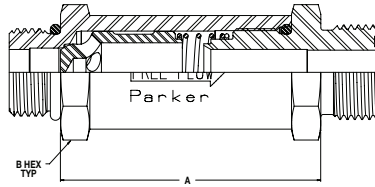

Valve Size	Part Number	Inlet Port Thread	Dimensions (in.)		Outlet Port Thread	** Std Crack Pressure (psi)	Max Operating Pressure (psi)
			Length	Wrench Flats			
			A	B			
1/4	CV-250-MOMS-**	7/16-20 UNF	1.53	.68	9/16-18 UNF	5, 65	3000
3/8	CV-370-MOMS-**	9/16-18 UNF	1.75	.81	11/16-16 UN	5, 65	3000
1/2	CV-500-MOMS-**	3/4-16 UNF	2.22	1.00	13/16-16 UN	5, 65	3000
5/8	CV-620-MOMS-**	7/8-14 UNF	2.41	1.12	1-14 UNS	5, 65	3000
3/4	CV-750-MOMS-**	1-1/16-12 UN	2.75	1.38	1-3/16-12 UN	5, 65	3000
1	CV-1000-MOMS-**	1-5/16-12 UN	3.31	1.62	1-7/16-12 UN	5, 65	3000

E Valves



WARNING: This product can expose you to chemicals including Lead, which is known to the State of California to cause cancer and birth defects or other reproductive harm. For more information go to www.P65Warnings.ca.gov

Flow Data

CV Series (1/4" & 3/8")
Test Fluid: Oil - 200 SUS

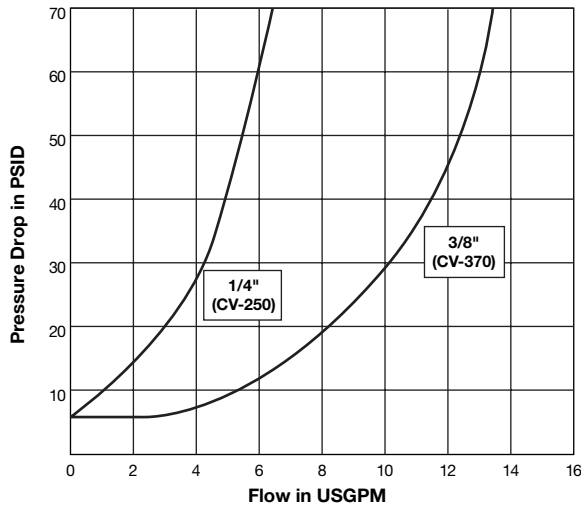

CV Series (1/2", 5/8", 3/4" & 1")
Test Fluid: Oil - 200 SUS

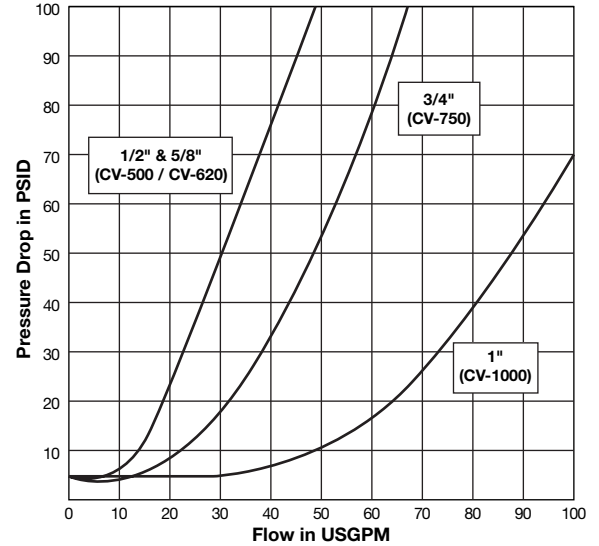

Ordering Information

CV - * * * * - * * * * - * *

CRACK PRESSURE
 5 - 5 PSI
 65 - 65 PSI
 Other Crack Pressures up to 200 PSI in 5 PSI increments are available. Contact the Division for price and delivery on non-standard crack pressures

SERIES	SIZE	FITTING STYLE
250	1/4"	MFMF - Male Flare Inlet to Male Flare Outlet
370	3/8"	MOMS - Male O-Ring Boss Inlet to Male Seal-Lok® Outlet
500	1/2"	
620	5/8"	
750	3/4"	
1000	1"	

NOTE: Contact QCD for additional port end options.

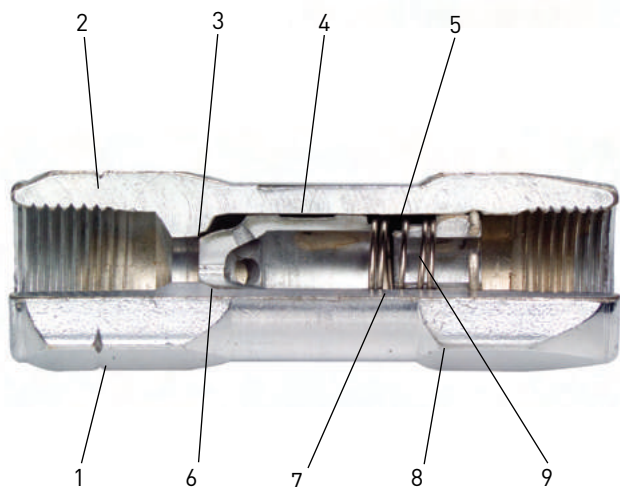

DC Series Check Valves are Rugged, Cost-competitive.

The DC Series offers basic, workhorse check valves – ruggedly built, readily available and reasonably priced. They are in-line valves, available in sizes 1/4” to 2”, with a pressure rating range up to 3000 psi, and flow capacities to 300 GPM.

Features

1. All-steel construction–no internal seals or gaskets to wear out.
2. One-piece body eliminates threads and seals that may be potential failure or leakage points.
3. Valve seats resist damage from shocks, surges and contamination.
4. Poppet has an oil retention groove that lubricates the bore and eliminates galling.
5. Poppet spring is isolated from the liquid flow stream, minimizing turbulence.
6. Poppet is heat treated to help prevent damage from shocks, surges and galling.
7. Close tolerance fit between poppet and poppet retainer creates a cushion that protects valve from surge shock damage.
8. Check valve body is shaped like an arrow to indicate flow direction.
9. Available in a variety of standard and non-standard crack pressures.

DC Series- Part Numbers							
Valve Size	Part Number	Inlet Port Thread	Dimensions (In.)		Outlet Port Thread	** Std Crack Pressure (psi)	Max Operating Pressure (psi)
			Length	Wrench Flats			
1/4	DC-250-**	1/4 - 18 NPSF	2.44	0.81	1/4 - 18 NPSF	1, 5, 65	3000
1/4	DC-250-FOFO-**	.438 - 20 UNF	2.44	0.81	.438 - 20 UNF	1, 5	3000
3/8	DC-370-**	3/8 - 18 NPSF	2.75	0.88	3/8 - 18 NPSF	1, 5, 65	3000
3/8	DC-370-FOFO-**	.562 - 18 UNF	2.75	0.88	.562 - 18 UNF	5	3000
1/2	DC-500-**	1/2 - 14 NPSF	3.5	1.06	1/2 - 14 NPSF	1, 5, 65	3000
1/2	DC-500-FOFO-**	.750 - 16 UNF	3.5	1.06	.750 - 16 UNF	5, 65	3000
3/4	DC-750-**	3/4 - 14 NPSF	3.88	1.37	3/4 - 14 NPSF	1, 5, 65	3000
3/4	DC-750-FOFO-**	1.062 - 12 UN	3.88	1.37	1.062 - 12 UN	5, 65	3000
1	DC-1000-**	1 - 11.5 NPSF	4.88	1.62	1 - 11.5 NPSF	5, 65	3000
1	DC-1000-FOFO-**	1.312 - 12 UN	4.88	1.62	1.312 - 12 UN	5, 65	3000
1-1/4	DC-1250-**	1-1/4 - 11.5 NPTF	5.94	2.00	1-1/4 - 11.5 NPTF	5, 65	3000
1-1/4	DC-1250-FOFO-**	1.625 - 12 UN	5.94	2.00	1.625 - 12 UN	5, 65	3000
1-1/2	DC-1500-**	1-1/2 - 11.5 NPTF	6.37	2.38	1-1/2 - 11.5 NPTF	5, 65	3000
1-1/2	DC-1500-FOFO-**	1.875 - 12 UN	6.37	2.38	1.875 - 12 UN	5, 65	3000
2	DC-2000-**	2 - 11.5 NPTF	7.00	3.00	2 - 11.5 NPTF	5, 65	3000
2	DC-2000-FOFO-**	2.500 - 12 UN	7.00	3.00	2.500 - 12 UN	65	3000

WARNING: This product can expose you to chemicals including Lead, which is known to the State of California to cause cancer and birth defects or other reproductive harm. For more information go to www.P65Warnings.ca.gov

Flow Data

DC Series (1/4")
Test Fluid: Oil - 200 SUS

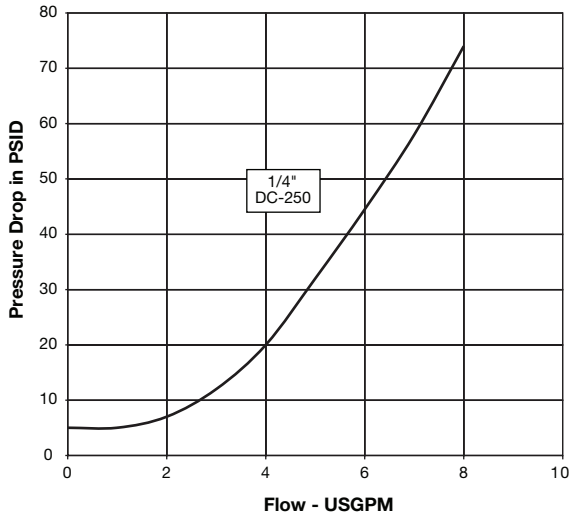

DC Series (3/8", 1/2" & 3/4")
Test Fluid: Oil - 200 SUS

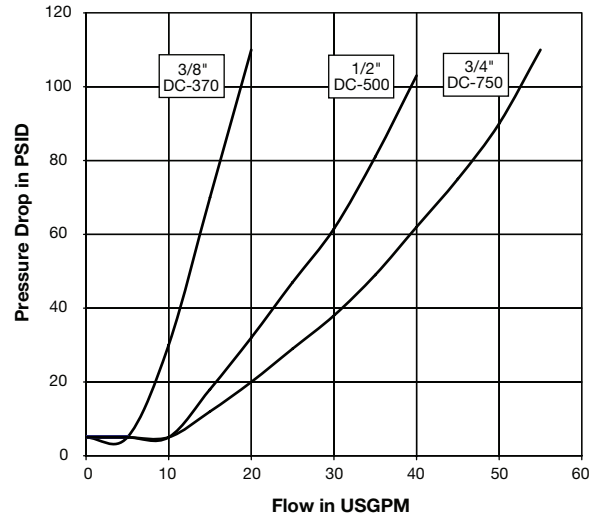

DC Series (1", 1-1/4", 1-1/2" & 2")
Test Fluid: Oil - 200 SUS

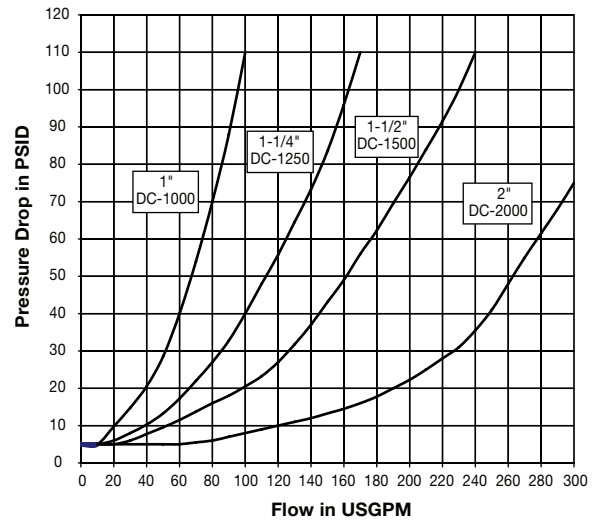

Ordering Information

DC - * - * - * - * - *

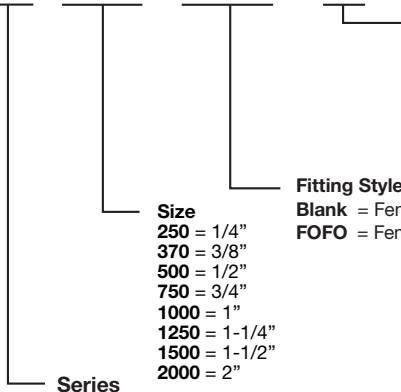

Crack Pressure:

- 1 = 1 PSI
 - 5 = 5 PSI
 - 65 = 65 PSI
- Other crack pressures up to 100 PSI (in 5 PSI increments) are available. Contact the Division for price and delivery on non-standard crack pressures.

Fitting Style:

- Blank = Female pipe inlet to Female pipe outlet
- FOFO = Female O-ring Boss inlet to Female O-ring Boss outlet

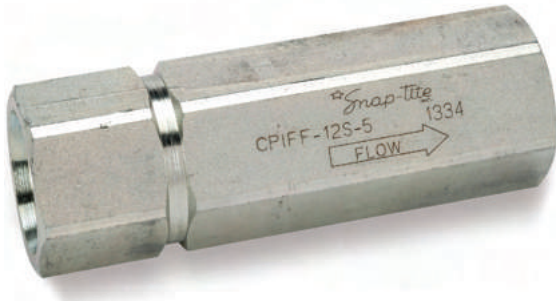

CPIFF Series Soft Seat Check Valves provide a positive shut off to prevent reverse flow.

CPIFF Series check valves are designed to protect hydraulic systems from fluid back pressure. The poppet is streamlined with minimum restriction of flow in one direction. Flow is blocked in the reverse direction as the soft seat creates a leak free seal in the closed position.

These in-line unidirectional valves are available in sizes 1/4" to 1" with a pressure rating up to 5000 psi. Standard spring crack pressures are shown in the part number table. Other crack pressures available upon request.

Features

1. Fluorocarbon poppet seal is standard.
2. Steel construction
3. Optional crack pressures available on request

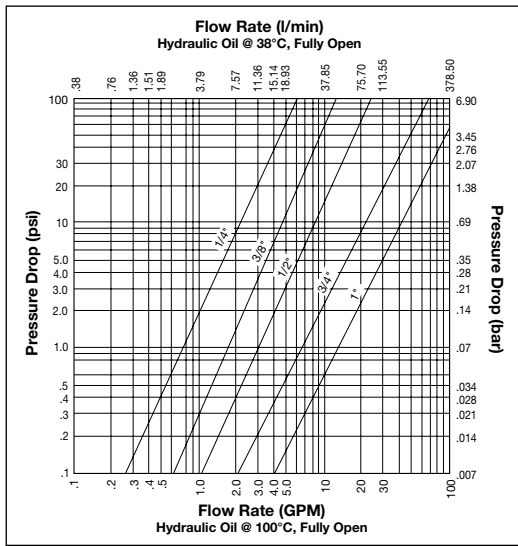

Specifications		
Size (in)	Max Pressure (psi)	Rated Flow (gpm)
1/4	5000	3
3/8	5000	8
1/2	5000	12
3/4	5000	20
1	5000	30

Seal Options (add code to part number)	
Code	Poppet Seal Material
suffix A	Nitrile
suffix E	Ethylene Propylene

CPIFF Series Part Numbers



Valve Size	Part Number	Inlet and Outlet Port Threads (Female)	Dimensions (In.)		Standard Seal Material	** Std Crack Pressure (psi)	Max Operating Pressure (psi)
			Length	Wrench Flats			
1/4	CPIFF-2P-**	1/4 - 18 NPSF	1.97	3/4	Fluorocarbon	5, 15, 25, 65	5000
3/8	CPIFF-3P-**	3/8 - 18 NPSF	2.60	1	Fluorocarbon	5, 15, 25, 65	5000
1/2	CPIFF-4P-**	1/2 - 14 NPSF	3.25	1-1/4	Fluorocarbon	5, 15, 25, 65	5000
1/2	CPIFF-8S-**	3/4 - 16 UNF	3.25	1-1/4	Fluorocarbon	5, 15, 25, 65	5000
3/4	CPIFF-6P-**	3/4 - 14 NPSF	4.33	1-3/8	Fluorocarbon	5, 15, 25, 65	5000
3/4	CPIFF-12S-**	1-1/16 - 12 UN	4.33	1-3/8	Fluorocarbon	5, 15, 25, 65	5000
1	CPIFF-8P-**	1 - 11-1/2 NPSF	4.78	1-3/4	Fluorocarbon	5, 15, 25, 65	5000
1	CPIFF-16S-**	1-5/16 - 12 UN	4.78	1-3/4	Fluorocarbon	5, 15, 25, 65	5000



WARNING: This product can expose you to chemicals including Lead, which is known to the State of California to cause cancer and birth defects or other reproductive harm. For more information go to www.P65Warnings.ca.gov



S6C and 3C Soft Seat Check Valves span a wide variety of sizes and end configurations.

S6C and 3C check valves have a variety of options enabling them to meet the needs of most systems. The soft seated poppet creates a leak free seal to protect hydraulic systems from reverse flow.

S6C check valves are stainless steel with a rated pressure of 6000 psi (sizes 1/4", 3/8", 1/2", 3/4" & 1"). 3C check valves are steel with a rated pressure of 3000 psi (sizes 1-1/4", 1-1/2" & 2").

These in-line unidirectional valves are available in sizes 1/4" to 2". Standard spring crack pressures are shown in the part number table. Other crack pressures available upon request.

Features

1. Fluorocarbon poppet seal is standard.
2. Steel or stainless steel construction
3. Optional crack pressures available on request
4. Contact QCD for other materials or configurations

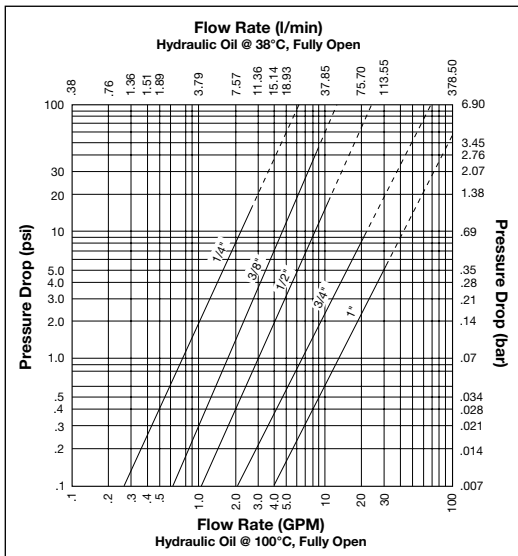

Specifications	
Size (in)	Rated Flow (gpm)
1/4	3
3/8	8
1/2	12
3/4	20
1	30
1-1/4	90
1-1/2	125
2	175

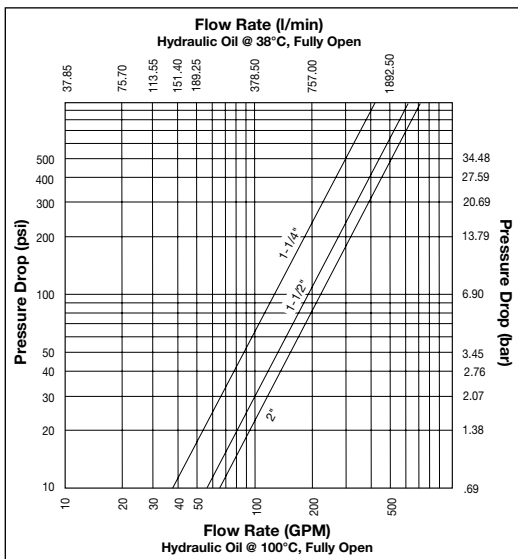

Seal Options (add code to part number)	
Code	Poppet Seal Material
suffix A	Nitrile
suffix E	Ethylene Propylene

E Valves

S6C Series Part Numbers



Valve Size	Part Number*	Inlet Port Threads	Dimensions (In.)		Outlet Port Threads	Standard Seal Material	** Std Crack Pressure (psi)	Max Operating Pressure (psi)
			Length	Wrench Flats				
1/4	S6C4F-F*	1/4 - 18 NPTF (female)	2.82	3/4	1/4 - 18 NPTF (female)	Fluorocarbon	5, 25, 65	6000
1/4	S6C4F-M*	1/4 - 18 NPTF (female)	2.65	3/4	1/4 - 18 NPT (male)	Fluorocarbon	5, 25, 65	6000
1/4	S6C4M-M*	1/4 - 18 NPT (male)	2.70	3/4	1/4 - 18 NPT (male)	Fluorocarbon	5, 25, 65	6000
3/8	S6C6F-F**	3/8 - 18 NPTF (female)	3.38	1-1/8	3/8 - 18 NPTF (female)	Fluorocarbon	5, 25, 65	6000
3/8	S6C6F-M*	3/8 - 18 NPTF (female)	3.18	1-1/8	3/8 - 18 NPT (male)	Fluorocarbon	5, 25, 65	6000
1/2	S6C8F-F*	1/2 - 14 NPTF (female)	3.73	1-1/4	1/2 - 14 NPTF (female)	Fluorocarbon	5, 25, 65	6000
1/2	S6C8M-F*	1/2 - 14 NPT (male)	4.20	1-1/4	1/2 - 14 NPTF (female)	Fluorocarbon	5, 25, 65	6000
1/2	S6C8M-M*	1/2 - 14 NPT (male)	4.04	1-1/4	1/2 - 14 NPT (male)	Fluorocarbon	5, 25, 65	6000
3/4	S6C12F-F*	3/4 - 14 NPTF (female)	4.91	1-5/8	3/4 - 14 NPTF (female)	Fluorocarbon	5, 25, 65	5000
1	S6C16F-F*	1 - 14 NPTF (female)	6.06	1-7/8	1 - 14 NPTF (female)	Fluorocarbon	5, 25, 65	4000

* Prop 65 Warning does not apply to stainless steel part numbers

3C Series Part Numbers



Valve Size	Part Number	Inlet and Outlet Port Threads (Female)	Dimensions (In.)		Standard Seal Material	** Std Crack Pressure (psi)	Max Operating Pressure (psi)
			Length	Wrench Flats			
1-1/4	3C20F-F**	1-1/4 - 11-1/2 NPTF	5.76	2	Fluorocarbon	5, 15, 25, 65	3000
1-1/4	3C20EF-EF**	1-5/8 - 12 UN	5.76	2	Fluorocarbon	5, 15, 25, 65	3000
1-1/4	3C20EM-EM**	1-5/8 - 12 UN (male 37° flare)	6.57	2	Fluorocarbon	5, 15, 25, 65	3000
1-1/2	3C24F-F**	1-1/2 - 11-1/2 NPTF	6.50	2-1/2	Fluorocarbon	5, 15, 25, 65	3000
1-1/2	3C24EF-EF**	1-7/8 - 12 UN	6.50	2-1/2	Fluorocarbon	5, 15, 25, 65	3000
2	3C32EF-EF**	2-1/2 - 12 UN	7.28	3-1/4	Fluorocarbon	5, 25, 65	3000



WARNING: This product can expose you to chemicals including Lead, which is known to the State of California to cause cancer and birth defects or other reproductive harm. For more information go to www.P65Warnings.ca.gov



Low Pressure and Lightweight

Constructed of lightweight aluminum, the 2600 Series Swing Check Valve has a spring-loaded, trapdoor style valve. The valve opens when system pressure approaches 1/2 psi to permit full flow with low pressure drop. As system pressure is relieved, the valve closes, retaining fluids upstream.

Parker’s 2600 Series are in-line check valves designed especially for diesel and gasoline engine fuel lines. They are also used for externally mounted oil filters, and coolers, as well as transmission fluid lubrication lines. With a maximum of 1/2 psi cracking pressure, these Swing Check Valves are useful in most low pressure air, liquid, or gas systems.

Features

- Lightweight, corrosion-resistant aluminum construction.
- Available with 1/4” or 3/8” NPTF ports.
- Standard Nitrile or Fluorocarbon seals.
- 1/2 PSI maximum crack pressure.
- Trapdoor style valve permits full flow with low pressure drop.

2600 Series Specifications	
Rated Pressure	250 psi max
Crack Pressure	1/2 psi max
Weight	0.08 lbs
Temperature Range	Nitrile: -40° to 200°F (-40° C to 93° C) Fluorocarbon: -40° to 400°F (-40° C to 204° C)
Max Leakage	5 cc / 24 hours at 28” head
Rated Flow	6 gpm (based on 3/8” hose size)

2600 Series Part Numbers				
Part Number	Thread	Seal Material	Dimensions	
			Length (mm)	Wrench Flats (in)
2600	1/4 - 18NPTF	Nitrile	2.06 [52]	1-1/16
2676	1/4 - 18NPTF	Fluorocarbon	2.06 [52]	1-1/16
2650	3/8 - 18NPTF	Nitrile	2.12 [54]	1-1/16
2625	3/8 - 18NPTF	Fluorocarbon	2.12 [54]	1-1/16



H1 Series Pressure/Vacuum Relief Valves are used to maintain positive pressure in hydraulic reservoirs. The compact size, reusable bronze filter and high flow characteristics make this valve a popular choice.

The HM1 Series offers the same features and characteristics as the H1 series with the option of manual over ride. This feature allows the operator to relieve the reservoir pressure before opening the tank for refilling, inspection or servicing.

Features

- Easy to remove, cleanable bronze filter.
- High flow characteristics.
- Compact size.
- Available with male pipe or male ORB threads.
- Wide variety of pressure relief settings.
- HM1 series has a manual pressure relief button.

H1 and HM1 Series Specifications		
	H1 Series	HM1 Series
Pressure Rating	60 psi max	
Filter Rating	10 micron, nominal	
Pressure Relief Setting	5 psi through 50 psi (in 5 psi increments)	
Vacuum Relief Setting	0.3 psi	
Weight	1.0 lbs	1.1 lbs

Flow Data H1 and HM1 Pressure-Vacuum Relief Valve

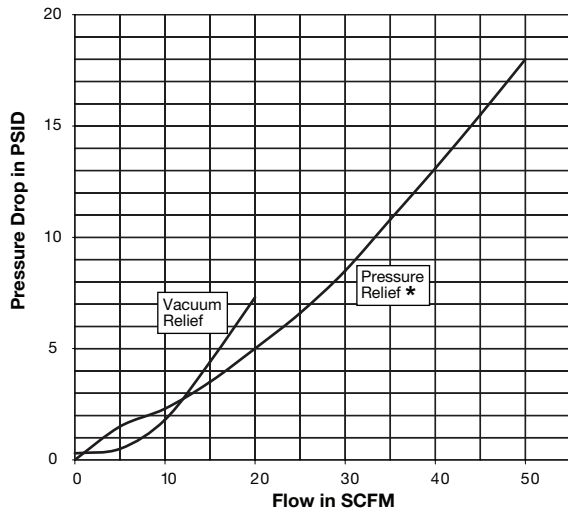

* Pressure drop is pressure relief valve crack pressure until pressure drop curve increases above pressure relief crack pressure.

Ordering Information

H * - * * - * * * *

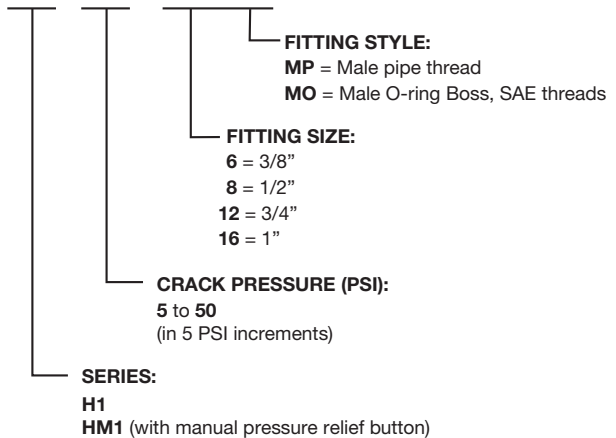



PV Series is an economical Pressure/Vacuum Relief Valve used to maintain positive pressure in hydraulic reservoirs. The large filter area makes this valve an ideal choice for use in heavily contaminated environments. The optional bayonet type mount allows the valve to be installed in the tank filler port, eliminating the need for an extra port. In this configuration, the valve also serves as a filler cap.

Features

- Disposable spin-on automotive type, field replaceable filter (240 sq inches).
- Several pressure relief settings.
- Economic design.
- Optional bayonet style allows mounting in filler port with valve also functioning as filler cap.

PV Series Specifications		
	PV Series	PV Bayonet Style
Filter Rating	10 micron, nominal (240 sq inches)	
Pressure Relief Setting	5 PSI through 30 PSI (in 5 PSI increments)	5 and 10 PSI
Vacuum Relief Setting	0.3 PSI	
Weight	1.0 lb.	
Mounting	Male ORB, SAE threads Male pipe threads	Bayonet style with tank receptacle gaskets & screws (optional strainer basket)
Replacement Filter Part Number	7312-009	

Flow Data PV Pressure-Vacuum Relief Valve

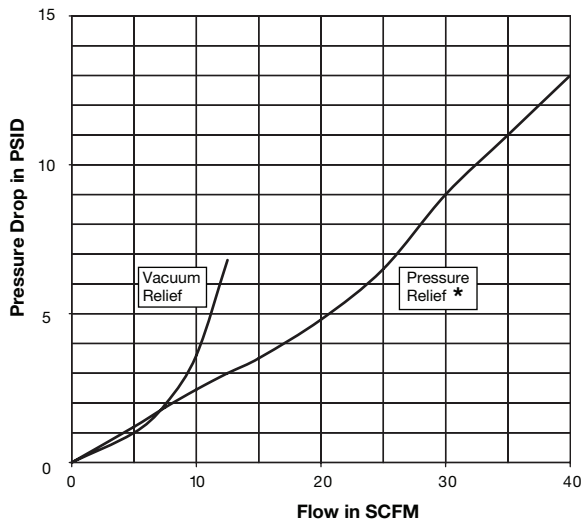

* Pressure drop is pressure relief valve crack pressure until pressure drop curve increases above pressure relief crack pressure.

Ordering Information

PV - ** - * - ****

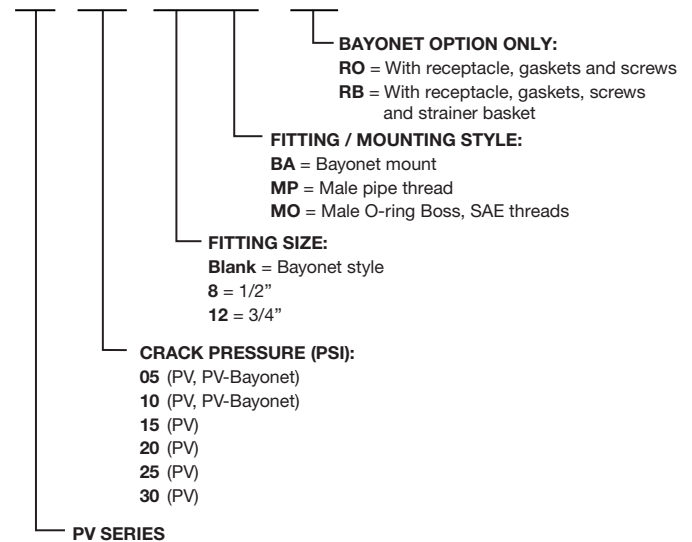

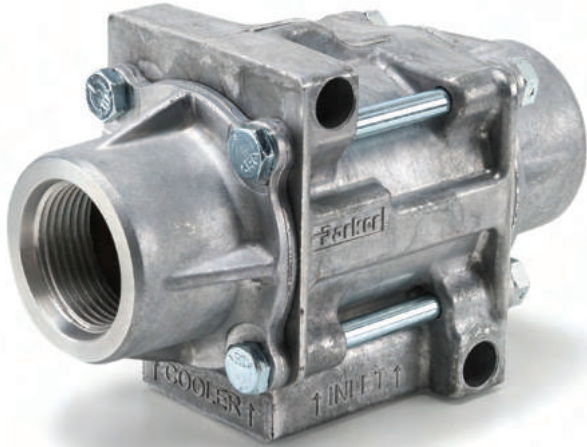

Maintain Optimum Fluid Temperature

Parker's thermal bypass valve will modulate fluid temperature by shifting return line flow through the cooler, or bypassing it directly to the reservoir.

Additionally, an integral pressure relief function automatically releases excess pressure to the reservoir if the cooler becomes restricted, and the inlet pressure becomes excessive. Relief crack pressure settings range from 5 to 85 PSI.

These lightweight, aluminum valves are ideal for hydrostatic drive circuits requiring fast warm-up, controlled fluid temperatures, and low return line back pressure.

Features

- Lightweight, corrosion-resistant aluminum housing.
- Available in five shift temperatures.
- Integral relief valve to dump excessive inlet pressures to the reservoir.
- 250 PSI maximum operating pressure.
- Up to 60 GPM flow rates.

Flow Data

Pressure Drop (Mobil DTE 26 oil)

**Inlet Port thru Tank Port
@ 100°F (300 SUS)**

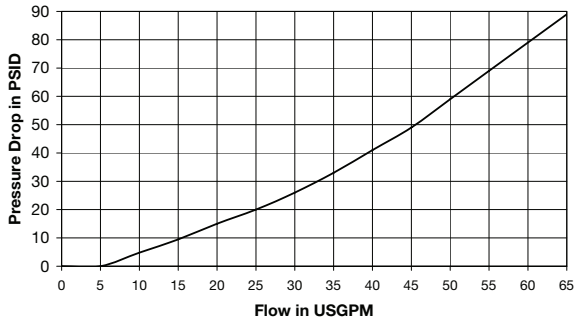

**Inlet Port over Integral Relief Valve
@ 170°F (78 SUS Oil)**

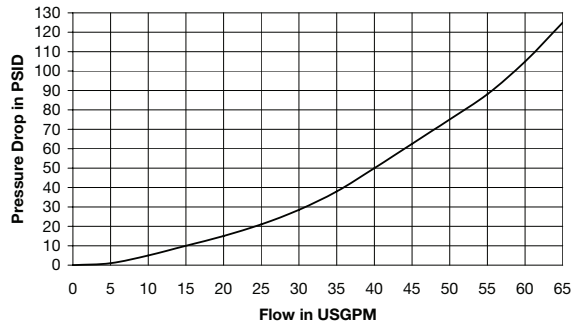

**Inlet Port thru Cooler Port
@ 145°F (110 SUS Oil)**

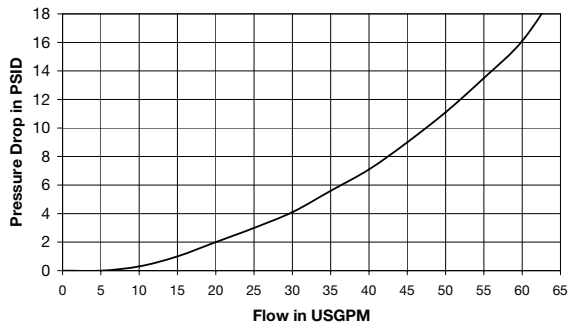

TH Series Specifications	
Size	1 inch
Weight	2.00 lbs
Std Shift Temperatures	100° F, 120° F, 140° F, 160° F, 180° F
Full Shift Temperature (cooler port open)	Shift Temperature plus 25° F
Proof Pressure	300 PSI (21 bar)
Minimum Burst Pressure	Up to full shift temperature: 325 PSI (22 bar) Above full shift temperature: 600 PSI (41 bar)
Operating Temperature	Min: -30° F Max: Shift temperature plus 75° F
Max Flow Rate	60 GPM (227 l/m)

Dimensions

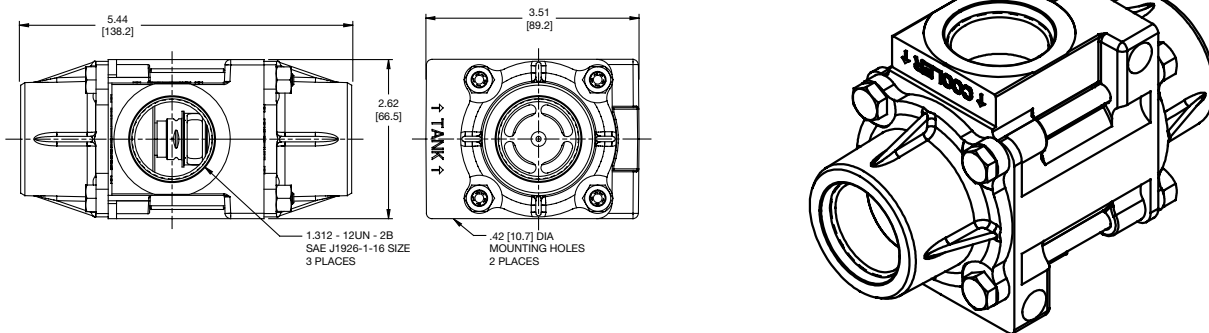

Ordering Information

TH - 1000 - 16FO - * *

VALVE SERIES:
Thermal Bypass

VALVE SIZE:
1000 = 1 inch

CRACK PRESSURE/TEMPERATURE CODE:
(see table)

PORT SIZE & STYLE:
16FO = 1 inch SAE O-Ring Boss (1.312 -12UN-2B thread)

Shift Temperature	Crack Pressure PSI																
	5 PSI	10 PSI	15 PSI	20 PSI	25 PSI	30 PSI	35 PSI	40 PSI	45 PSI	50 PSI	55 PSI	60 PSI	65 PSI	70 PSI	75 PSI	80 PSI	85 PSI
100° F (38° C)	01	02	03	04	05	06	07	08	09	10	11	12	13	14	15	16	17
120° F (49° C)	21	22	23	24	25	26	27	28	29	30	31	32	33	34	35	36	37
140° F (60° C)	41	42	43	44	45	46	47	48	49	50	51	52	53	54	55	56	57
160° F (71° C)	61	62	63	64	65	66	67	68	69	70	71	72	73	74	75	76	77
180° F (82° C)	81	82	83	84	85	86	87	88	89	90	91	92	93	94	95	96	97

Appendix

Codes

The following seal compound and body material compatibility chart is provided as an aid in selecting a specific synthetic rubber compound or body material for a particular application. Operating and environmental conditions must be considered when making the selection of a quick coupling.

Refer to the appropriate section of the catalog for Ordering Information for Seal Codes for specific products.

To indicate a special material just add the appropriate code letter as a suffix to the catalog number of the coupler.

It is not necessary to use the code "STD" as the standard Nitrile seal will be used when another code is not used.

For recommendations for media not listed below, please contact your Parker representative or the factory.

Note

This chart is intended as a guide only and is not be considered as a recommendation to use Parker quick action couplings in a specific application or with a specific fluid, other factors that must be considered include but are not limited to: fluid and ambient temperature, system pressure, both operating and peak, frequency of connect and disconnect, and applicable standards or regulations.

CODES: 1 = Satisfactory 2 = Fair 3 = Not Recommended 4 = Insufficient Data Available

MEDIA	BODY MATERIAL				SEAL MATERIAL			
	Brass	Steel	316 S.S.	303 S.S.	Nitrile	E.P.	Fluorocarbon	Neoprene
3M FC-75	4	4	4	4	1	1	2	1
ACETAMIDE	4	4	1	2	1	1	3	1
ACETIC ACID (5%)	3	3	1	1	2	1	1	1
ACETONE	1	2	1	1	3	1	3	3
ACETOPHENONE	2	2	2	1	3	1	3	3
ACETYL ACETONE	2	2	2	2	3	1	3	3
ACETYL CHLORIDE	4	2	2	2	3	3	1	3
ACETYLENE	3	2	1	1	1	1	1	2
AIR (200 DEGREES F.)	1	2	1	1	1	1	1	1
AIR (300 DEGREES F.)	1	2	1	1	2	2	1	2
AIR (400 DEGREES F.)	1	2	1	1	3	3	1	3
ALUMINUM ACETATE	4	4	4	4	2	1	3	2
ALUMINUM BROMIDE	4	4	4	4	1	1	1	1
ALUMINUM CHLORIDE (10%)	3	3	3	3	1	1	1	1
ALUMINUM CHLORIDE (100%)	3	2	2	2	1	1	1	1
ALUMINUM FLOURIDE	3	3	3	3	1	1	1	1
ALUMINUM NITRATE	3	3	2	2	1	1	1	1
ALUMINUM SALTS	4	4	4	4	1	1	1	1
ALUMINUM SULPHATE	2	3	2	3	1	1	1	1
ALUMS (NH3,Cr,K)	4	4	4	4	1	1	3	1
AMMONIA (ANHYDROUS)	3	2	1	1	2	1	3	1
AMMONIA (COLD, GAS)	3	2	4	1	1	1	3	1
AMMONIA (HOT, GAS)	3	2	4	1	3	2	3	2
AMMONIUM CARBONATE	3	2	3	3	3	1	1	1
AMMONIUM CHLORIDE	3	3	2	3	1	1	1	1
AMMONIUM HYDROXIDE	3	3	1	2	3	1	3	1
AMMONIUM NITRATE	3	3	1	1	1	1	4	1
AMMONIUM PERSULFATE SOLUTION	3	3	1	2	3	1	4	4
AMMONIUM PHOSPHATE (MONO-, DI-, TRI-BASIC)	3	3	3	2	1	1	4	1
AMMONIUM SALTS	4	4	4	4	1	1	3	1
AMMONIUM SULFATE	3	3	2	3	1	1	3	1
AMYL BORATE	4	4	4	4	1	3	1	1
AMYL CHLORIDE	4	2	1	1	4	3	1	3
AMYL CHLORONAPHTHALENE	4	4	4	4	3	3	1	3
AMYL NAPHTHALENE	4	4	4	4	3	3	1	3
ANIMAL OIL (LARD OIL)	2	2	2	2	1	2	1	2
AROCLOR 1248	2	3	3	3	3	2	1	3
AROCLOR 1254	2	3	3	3	3	2	1	3
AROCLOR 1260	2	3	3	3	1	4	1	1
AROMATIC FUEL (50%)	4	4	4	4	2	3	1	3
ARSENIC ACID	3	3	1	1	1	1	1	1
ASPHALT	3	3	1	1	2	3	1	2
ASTM OIL, NO. 1	1	1	1	1	1	3	1	1
ASTM OIL, NO. 2	1	1	1	1	1	3	1	2



CODES: 1 = Satisfactory 2 = Fair 3 = Not Recommended 4 = Insufficient Data Available

MEDIA	BODY MATERIAL				SEAL MATERIAL			
	Brass	Steel	316 S.S.	303 S.S.	Nitrile	E.P.	Fluorocarbon	Neoprene
ASTM OIL, NO. 3	1	1	1	1	1	3	1	3
ASTM OIL, NO. 4	1	1	1	1	2	3	1	3
ASTM REFERENCE FUEL A	3	2	1	1	1	3	1	2
ASTM REFERENCE FUEL B	3	2	1	1	1	3	1	3
ASTM REFERENCE FUEL C	3	2	1	1	2	3	1	3
AUTOMOTIVE BRAKE FLUID	4	4	4	4	3	1	3	2
BARIUM CHLORIDE	3	3	2	3	1	1	1	1
BARIUM HYDROXIDE	3	2	2	3	1	1	1	1
BARIUM SALTS	4	4	4	4	1	1	1	1
BARIUM SULFIDE	3	2	3	3	1	1	1	1
BEER	3	3	1	1	1	1	1	1
BEET SUGAR LIQUORS	3	3	1	1	1	1	1	2
BENZALDEHYDE	3	3	2	3	3	1	3	3
BENZENE	3	2	3	3	3	3	1	3
BENZENESULFONIC ACID (10%)	3	3	3	3	3	3	1	2
BENZINE	4	4	4	4	1	3	1	2
BENZOIC ACID	3	3	3	3	3	3	1	3
BENZYL ALCOHOL	4	3	1	2	3	2	1	2
BENZYL CHLORIDE	3	3	2	3	3	3	1	3
BLEACH LIQUOR	4	4	4	4	3	1	1	2
BORAX	3	2	3	3	2	1	1	3
BORDEAUX MIXTURE	4	4	4	4	2	1	1	2
BORIC ACID	3	3	2	3	1	1	1	1
BRAKE FLUID (NON-PETROLEUM)	4	4	4	4	3	1	3	2
BRINE (SODIUM CHLORIDE)	3	3	1	1	1	1	1	1
BROMINE	4	4	4	4	3	3	1	3
BROMINE WATER	4	4	4	4	3	2	1	3
BUNKER OIL	4	4	4	4	1	3	1	3
BUTADIENE (MONOMER)	3	2	1	2	3	3	1	3
BUTANE	3	1	1	1	1	3	1	1
BUTANE (2,2, & 2,3-DIMETHYL)	4	4	4	4	1	3	1	2
BUTANOL (BUTYL ALCOHOL)	2	1	1	1	1	2	1	1
BUTTER - ANIMAL FAT	2	3	1	2	1	1	1	2
BUTYL BUTYRATE	4	4	4	4	3	1	1	3
BUTYL STEARATE	4	4	4	4	2	3	1	3
CALCINE LIQUORS	4	4	4	4	1	1	1	4
CALCIUM ACETATE	4	4	4	4	2	1	3	2
CALCIUM BISULFITE	3	3	2	3	2	1	2	2
CALCIUM CARBONATE	3	2	3	2	1	1	1	1
CALCIUM CHLORIDE	3	3	2	3	1	1	1	1
CALCIUM HYDROXIDE	3	3	2	3	1	1	1	1
CALCIUM HYPOCHLORITE	3	3	2	3	2	1	1	2
CALCIUM SALTS	4	4	4	4	1	1	1	1
CALCIUM SULFIDE	3	3	2	2	1	1	1	1
CALICHE LIQUORS	4	4	4	4	1	1	1	1
CANE SUGAR LIQUORS	4	2	1	1	1	1	1	1
CARBON BISULPHIDE	4	4	4	4	3	3	1	3
CARBON DIOXIDE	1	2	1	1	1	1	1	1
CARBON DISULFIDE	2	2	2	2	3	3	1	3
CARBON MONOXIDE	1	1	1	1	1	1	1	2
CARBON TETRACHLORIDE	2	3	1	3	2	3	1	3
CARBONIC ACID	3	3	1	2	2	1	1	1
CASTOR OIL	1	1	1	1	1	2	1	1
CELLUGUARD	4	4	4	4	1	1	1	1
CELLULUBE (NOW FYRQUEL)	4	4	4	4	3	1	1	3
CHINA WOOD OIL (TUNG OIL)	2	2	1	1	1	3	1	2
CHLORINATED SALT BRINE	4	4	4	4	3	3	1	3
CHLORINATED SOLVENTS	4	4	4	4	3	3	1	3
CHLOROBENZENE	3	3	2	3	3	3	1	3
CHLOROBUTADIENE	4	4	4	4	3	3	1	3
CHLOROFORM	3	2	2	1	3	3	1	3
CHLORPHENOL	4	4	4	4	3	3	1	3
COCONUT OIL	4	4	4	4	1	3	1	3
COPPER CHLORIDE	4	4	4	4	1	1	1	2
COPPER SALTS	4	4	4	4	1	1	1	1
COPPER SULFATE	3	3	2	3	1	1	1	1

CODES: 1 = Satisfactory 2 = Fair 3 = Not Recommended 4 = Insufficient Data Available

MEDIA	BODY MATERIAL				SEAL MATERIAL			
	Brass	Steel	316 S.S.	303 S.S.	Nitrile	E.P.	Fluorocarbon	Neoprene
CORN OIL	2	1	1	1	1	3	1	3
COTTONSEED OIL	3	2	1	2	1	3	1	3
CREOSOLS	3	2	1	2	3	3	1	3
CREOSOTE	3	3	2	1	1	3	1	2
CRESYLIC ACID	4	2	1	2	3	3	1	3
CRUDE OIL	3	2	1	1	2	3	1	3
CUTTING OIL	4	1	1	1	1	3	1	2
DECANE	4	4	4	4	1	3	1	3
DENATURED ALCOHOL	4	4	4	4	1	1	1	1
DETERGENT, WATER SOLUTION	3	3	1	1	1	1	1	2
DIESEL FUEL	1	1	1	1	1	3	1	3
DIETHYLENE GLYCOL	3	1	1	1	1	1	1	1
DIMETHYL FORMAMIDE	4	4	1	1	2	1	3	3
DOW CHEMICAL HD50-4	4	4	4	4	4	1	3	2
DOW CORNING 200, 510, 550	4	4	4	4	2	1	1	1
DOWTHERM A,E	3	1	2	2	3	3	1	3
ETHANOL	1	3	3	3	3	1	3	1
ETHYL CHLORIDE	2	3	1	3	1	3	1	3
ETHYL HEXANOL	4	4	4	4	1	1	1	1
ETHYLENE DICHLORIDE	3	3	1	2	3	3	1	3
ETHYLENE GLYCOL	2	2	1	2	1	1	1	1
FATTY ACIDS	3	3	1	2	2	3	1	2
FREON 11	1	4	4	4	2	3	2	3
FREON 12	1	1	3	1	2	3	1	1
FREON 22	1	3	1	1	3	3	3	1
FREON 134a	1	1	1	1	2	1	4	1
FUEL OIL	3	1	1	1	1	3	1	2
GALLIC ACID	3	3	2	2	2	2	1	2
GAS, LIQUID, PROPANE (LPG)	1	3	1	1	1	3	1	2
GAS, NATURAL	2	3	1	1	1	3	1	1
GASOLINE	1	2	1	1	3	3	1	3
GELATIN	3	3	1	1	1	1	1	1
GLUCOSE	1	1	1	1	1	1	1	1
GLYCERINE (GLYCEROL)	2	1	1	1	1	1	1	1
GLYCOLS	3	2	2	2	1	1	3	1
GREEN SULFATE LIQUOR	3	3	3	3	2	1	1	2
GULF - FR FLUID (EMULSION)	4	4	4	4	1	3	1	2
GULF - FR FLUID G	4	4	4	4	1	1	1	1
GULF - FR FLUID P	4	4	4	4	3	2	2	3
HELIUM	1	1	1	1	1	1	1	1
HEPTANE	1	1	1	1	1	3	1	2
HYDRAULIC OIL (PETROLEUM BASE)	1	1	1	1	1	3	1	1
HYDRAULIC OIL (WATER BASE)	4	1	1	1	2	1	3	2
HYDRAZINE	4	3	1	1	2	1	3	2
HYDROGEN GAS	2	2	1	1	1	1	1	1
HYDROLUBE	4	4	4	4	1	1	1	2
ISO OCTANE	1	1	1	1	1	3	1	2
ISOBUTYL ALCOHOL	4	4	1	1	2	1	1	1
ISOPROPYL ALCOHOL	1	1	2	1	2	1	1	2
ISOPROPYL ETHER	1	1	1	1	2	3	3	3
JP3 AND JP4	1	1	1	1	1	3	1	3
KEROSENE	1	1	1	1	1	3	1	2
LARD, ANIMAL FAT	1	1	1	1	1	2	1	2
LINSEED OIL	3	1	1	1	1	3	1	3
LUBRICATING OIL SAE 10, 20, 30, 40, 50	1	1	1	1	1	3	1	2
MAGNESIUM SALTS	4	4	4	4	1	1	1	1
MAGNESIUM SULPHATE	3	3	2	2	1	1	1	1
MERCURY	3	3	1	1	1	1	1	1
METHANE	1	3	1	1	1	3	1	2
METHANOL	1	1	1	1	1	1	3	1
METHYL BROMIDE	4	1	1	1	2	3	1	3
METHYL CHLORIDE (DRY)	2	3	1	1	3	3	1	3
METHYL CHLORIDE (WET)	1	3	1	3	3	3	1	3
METHYL ETHER	4	4	4	4	1	3	1	3
METHYL ETHYL KETONE (MEK)	1	1	1	1	3	1	3	3
MIL-F-81912 (JP-9)	1	1	1	1	3	3	1	3

CODES: 1 = Satisfactory 2 = Fair 3 = Not Recommended 4 = Insufficient Data Available

MEDIA	BODY MATERIAL				SEAL MATERIAL			
	Brass	Steel	316 S.S.	303 S.S.	Nitrile	E.P.	Fluorocarbon	Neoprene
MIL-H-5606	1	1	1	1	1	3	1	2
MIL-H-6083	1	1	1	1	1	3	1	1
MIL-H-7083	1	1	1	1	1	1	2	2
MIL-H-8446 (MLO-8515)	2	1	1	1	2	3	1	1
MIL-L-2104 & 2104B	1	1	1	1	1	3	1	2
MIL-L-7808	3	2	1	1	2	3	1	3
MILK	2	1	1	1	1	1	1	1
MINERAL OILS	1	1	1	1	1	3	1	2
MLO-7277 AND MLO-7557	2	1	1	1	3	3	1	3
MOBILE HF	1	1	1	1	1	3	1	2
MONOMETHYL HYDRAZINE	4	4	4	4	2	1	4	2
NAPHTHA (COAL OR PETROLEUM)	2	1	2	2	2	3	1	3
NAPHTHALENE	2	1	2	2	3	3	1	3
NAPHTHENIC ACID	2	1	2	2	2	3	1	3
NEATSFOOT OIL	4	4	4	4	1	2	1	3
NICKEL, ACETATE	3	2	1	1	2	1	3	2
NICKEL CHLORIDE	3	3	2	2	1	1	1	2
NICKEL SALTS	4	4	4	4	1	1	1	2
NICKEL SULFATE	3	3	1	1	1	1	1	1
NITROGEN	1	1	1	1	1	1	1	1
NITROUS OXIDE	2	2	2	1	1	4	4	4
OCTYL ALCOHOL	1	1	1	1	2	3	1	2
OLIVE OIL	2	1	1	1	1	2	1	2
ORTHO-DICHLOROBENZENE	2	2	2	2	3	3	1	3
OXALIC ACID	3	3	2	1	2	1	1	2
OXYGEN (200-400 DEGREES F.)	1	1	1	1	3	3	2	3
OXYGEN, COLD	1	1	1	1	2	1	1	1
OZONE	3	3	1	1	3	1	1	3
PALMITIC ACID	1	2	1	1	1	2	1	2
PARA-DICHLOROBENZENE	2	1	1	2	3	3	1	3
PARKER O LUBE	1	1	1	1	1	3	1	1
PEANUT OIL	2	1	1	1	1	3	1	3
PENTANE (2-3-METHYL, & 2-4 DIMETHYL)	2	2	2	2	1	3	1	2
PERCHLORIC ACID -2N	3	3	2	2	3	2	1	2
PERCHLOROETHYLENE	3	2	2	2	2	3	1	3
PETROLATUM	1	1	1	1	1	3	1	2
PETROLEUM OIL, BELOW 250 DEGREES F.	1	1	1	1	1	3	1	2
PHENOL	1	1	1	1	3	3	1	3
PHOSPHORIC ACID (3 MOLAR)	3	3	2	2	1	1	1	2
PHOSPHORIC ACID (CONCENTRATED)	3	3	2	2	3	1	1	3
PHOSPHOROUS TRICHLORIDE	3	3	1	1	3	1	1	3
PICRIC ACID, MOLTEN	3	3	2	2	2	2	1	2
PICRIC ACID, WATER SOLUTION	3	3	2	2	1	1	1	1
PINE OIL	2	2	1	2	1	3	1	3
PLATING SOLUTIONS (CHROME)	1	3	1	1	4	1	1	3
PLATING SOLUTIONS (OTHER)	4	1	1	1	1	1	1	3
PNEUMATIC SERVICE	1	1	1	1	1	1	1	1
POTASSIUM ACETATE	2	1	2	2	2	1	3	2
POTASSIUM CHLORIDE	3	3	1	2	1	1	1	1
POTASSIUM CYANIDE	3	2	2	2	1	1	1	1
POTASSIUM DICHROMATE	3	1	2	2	1	1	1	1
POTASSIUM HYDROXIDE (50%)	3	2	1	2	2	1	3	2
POTASSIUM NITRATE	2	1	1	1	1	1	1	1
POTASSIUM SALTS	4	4	4	4	1	1	1	1
POTASSIUM SULFATE	3	2	1	1	1	1	1	1
PRL-HIGH TEMP. HYDR. OIL	4	4	4	4	2	3	1	2
PRODUCER GAS	2	1	1	1	1	3	1	2
PROPANE	1	3	1	1	1	3	1	2
PROPYL ACETATE	3	1	1	1	3	2	3	3
PROPYL ALCOHOL	1	1	1	1	1	1	1	1
PROPYLENE	1	1	1	1	3	3	1	3
PYDRAUL 10E	3	1	1	1	3	1	3	3
PYDRAUL A-200, C SERIES	3	1	1	1	3	3	1	3
PYDRAUL, 3 SERIES	3	1	1	1	3	1	1	3
PYROGARD 42, 43, 53, 55 (PHOSPHATE ESTER)	4	4	4	4	3	1	1	3

Appendices



CODES: 1 = Satisfactory 2 = Fair 3 = Not Recommended 4 = Insufficient Data Available

MEDIA	BODY MATERIAL				SEAL MATERIAL			
	Brass	Steel	316 S.S.	303 S.S.	Nitrile	E.P.	Fluorocarbon	Neoprene
PYROGARD D	4	4	4	4	1	3	3	2
SEA WATER (SALT WATER)	2	3	1	1	1	1	1	2
SHELL IRUS 905	4	4	4	4	1	3	1	2
SILICONE GREASES	1	1	1	1	1	1	1	1
SILVER NITRATE	3	3	1	2	2	1	1	1
SKYDROL 500, TYPE 2	3	1	1	1	3	1	3	3
SKYDROL 7000, TYPE 2	3	1	1	1	3	1	2	3
SOAP SOLUTIONS	3	3	1	1	1	1	1	2
SODIUM ACETATE	1	1	1	1	2	1	3	2
SODIUM BICARBONATE (BAKING SODA)	2	2	1	1	1	1	1	1
SODIUM BISULPHATE OR BISULPHITE	3	3	2	1	1	1	1	1
SODIUM BORATE	3	2	2	2	1	1	1	1
SODIUM CARBONATE (SODA ASH)	4	1	1	1	1	1	1	1
SODIUM CHLORIDE	3	2	2	2	1	1	1	1
SODIUM CYANIDE	3	1	1	1	1	1	4	1
SODIUM HYDROXIDE (CAUSTIC SODA, LYE)	3	2	1	2	2	1	2	2
SODIUM HYDROXIDE, 50%	3	3	1	2	2	1	2	2
SODIUM METAPHOSPHATE	2	1	2	2	1	1	1	2
SODIUM NITRATE	3	2	1	1	2	1	4	2
SODIUM PERBORATE	3	3	1	1	2	1	1	2
SODIUM PEROXIDE	3	1	2	2	2	1	1	2
SODIUM PHOSPHATES	1	3	2	1	1	1	1	2
SODIUM SALTS	4	4	4	4	1	1	1	2
SODIUM SULFATE	3	2	1	1	1	1	1	1
SODIUM SULFIDE AND SULFITE	3	3	2	3	1	1	1	1
SODIUM THIOSULFATE	3	3	1	2	2	1	1	1
SOYBEAN OIL	2	1	1	1	1	3	1	3
STANNOUS CHLORIDE (15%)	3	3	2	3	1	1	1	1
STEAM, BELOW 400 DEGREEES F.	1	3	1	1	3	1*	3	3
STODDARD SOLVENT	2	1	1	1	1	3	1	2
SUCROSE SOLUTIONS	1	1	1	1	1	1	1	2
SULFUR	2	1	1	1	3	1	1	1
SULFUR LIQUORS	1	1	1	1	2	2	1	2
SULFUR (MOLTEN)	3	3	1	1	3	3	1	3
SULFUR DIOXIDE (DRY)	3	1	1	3	3	1	3	3
SULFUR TRIOXIDE (DRY)	2	2	2	3	3	2	1	3
SUNSAFE	3	1	1	1	1	3	1	2
TANNIC ACID (10%)	1	3	2	3	1	1	1	2
TAR, BITUMINOUS	2	1	1	1	2	3	1	3
TARTARIC ACID	2	3	3	2	1	2	1	2
TERPINEOL	4	4	4	4	2	3	1	3
TERTIARY BUTYL ALCOHOL	1	1	1	1	2	2	1	2
TETRACHLOROETHANE	4	2	1	2	3	3	1	3
TETRACHLOROETHYLENE	3	2	2	4	3	3	1	3
TETRAETHYL LEAD	1	1	1	1	2	3	1	2
TETRAETHYL LEAD (BLEND)	1	1	1	1	2	3	1	3
TITANIUM TETRACHLORIDE	2	1	2	3	2	3	1	3
TOLUENE	1	1	1	1	3	3	1	3
TRANSFORMER OIL	1	1	1	1	1	3	1	2
TRANSMISSION FLUID (TYPE A)	1	1	1	1	1	3	1	2
TRICHLOROETHANE	4	2	1	4	3	3	1	3
TRICHLOROETHYLENE	3	2	2	2	3	3	1	3
TRICRESYL PHOSPHATE	4	1	2	2	3	1	2	3
TURBINE OIL #15 (MIL-L-7808A)	4	2	1	1	2	3	1	3
TURPENTINE	3	2	1	1	1	3	1	3
VARNISH	1	1	1	1	2	3	1	3
WATER	1	3	1	1	1	1	2	2
WHISKEY	1	3	1	1	1	1	1	1
WINE	1	3	1	1	1	1	1	1
WOOD OIL	4	2	1	1	1	3	1	2
XYLENE	1	2	1	1	3	3	1	3
ZINC SULFATE	3	3	2	2	1	1	1	1

Ratings Code:

- G** – Good to excellent. Little or no swelling, tensile or surface changes. Preferred choice.
- L** – Marginal or conditional. Noticeable effects but not necessarily indicating lack of serviceability. Further testing suggested for specific application. Very long-term effects such as stiffening or potential for crazing should be evaluated.
- P** – Poor or unsatisfactory. Not recommended without extensive and realistic testing.
- – Indicates that this was not tested.
- # – For Teflon. Indicates good chemical resistance but potential for excessive permeation.

MEDIA	Rating
Acetaldehyde	P
Acetates	L
Acetic Acid	G
Acetic Anhydride	L
Acetone	G
Acetyl Bromide	–
Acetyl Chloride	L
Air	G
Alcohols	L
Aluminum Salts	G
Ammonia	G
Amyl Acetate	L
Aniline	G
Animal Oils	G
Arsenic Salts	L
Aromatic Hydrocarbons	–
Barium Salts	G
Benzaldehyde	L
Benzene (Benzol)	L
Benzyl Alcohol	G
Bleaching Liquors	–
Boric Acid Solution	G
Bromine	P
Butane	L
Butanol	–
Butyl Acetate	P
Calcium Salts	G
Carbon Dioxide	G
Carbon Disulfide	L
Carbon Tetrachloride	P
Caustic Potash	G
Caustic Soda	G
Chloracetic Acid	L
Chlorine (Dry)	P
Chlorine (Wet)	P
Chlorobenzene	P
Chloroform	P
Chromic Acid	G
Copper Salts	G
Cresol	L
Cyclohexanone	L
Ethers	P
Ethyl Acetate	L
Ethyl Alcohol	G
Ethylamine	L
Ethyl Bromide	–
Ethyl Chloride	P
Fatty Acids	G
Ferric Salts	G
Formaldehyde	G
Formic Acid	G
Freon	L
Gasoline	L
Glucose	G

MEDIA	Rating
Glycerine	G
Hydriodic Acid	–
Hydrochloric Acid (Conc.)	G
Hydrochloric Acid (Med. Conc.)	G
Hydrofluoric Acid	G
Hydrogen Peroxide (Conc.)	L
Hydrogen Peroxide (Dil.)	L
Hydrogen Sulfide	G
Iodine	G
Kerosene	P
Ketones	G
Lacquer Solvent	L
Lactic Acid	G
Lead Acetate	G
Linseed Oil	G
Magnesium Salts	G
Naphtha	L
Natural Gas	L
Nickel Salts	G
Nitric Acid (Conc.)	P
Nitric Acid (Dil.)	L
Nitrobenzene	G
Nitrogen Oxides	–
Nitrous Acid	G
Oils (Animal and Mineral)	L
Oils (Vegetable)	L
Oxygen	L
Perchloric Acid	L
Phenol	G
Potassium Salts	G
Pyridine	G
Silver Nitrate	G
Soap Solutions	G
Sodium Salts	G
Stearic Acid	L
Sulfur Chloride	P
Sulfuric Acid (Conc.)	L
Sulfuric Acid (Dil.)	G
Sulfurous Acid	L
Tannic Acid	G
Tanning Extracts	L
Titanium Salts	–
Toluene (Toluol)	P
Trichloroacetic Acid	G
Trichlorethylene	P
Turpentine	P
Urea	G
Uric Acid	–
Water	G
Xylene (Xylol)	P
Zinc Chloride	G

Appendix

Part Number Index

Part Number	Page	Part Number	Page	Part Number	Page
0C.....	A-19	21SFIN13MXN (HF-124-4FP) .	A-16	3050-3	B-82
0E.....	A-19	23KAAN13MPN (HF-251-4MP)A-17		3050-3-231	B-82
0F.....	A-19	23KAAN17MPN (HF-251-6MP)A-17		3613001	B-93
1C.....	A-19	23KAIN13MPN (HF-251-4FP) .	A-17	3C20EF-EF.....	E-16
1E.....	A-19	23KAIN17MPN (HF-251-6FP) .	A-17	3C20EM-EM.....	E-16
1F.....	A-19	23KATF06MPN (HF-251-4HB) A-17		3C20F-F.....	E-16
2C.....	A-19	23KATF10MPN (HF-251-6HB) A-17		3C24EF-EF.....	E-16
2C-E.....	A-19	23KATP06MPN (HF-251-4PL) A-17		3C24F-F.....	E-16
2E.....	A-19	23KATP10MPN (HF-251-6PL) A-17		3C32EF-EF.....	E-16
2F.....	A-19	24.....	A-10	4010-2P.....	B-36
3C.....	A-19	24-4 LHL6G5TP	B-110	4010-3P.....	B-36, B-39
3C-E.....	A-19	24-4 XHX6G5TP.....	B-110	4010-6P.....	B-36
3E.....	A-19	24-5B.....	A-11	4010-T6.....	B-36
3F.....	A-19	24-5BP.....	A-11	4050-15.....	B-36
4-4 LHL6G5TP.....	B-110	24-6B.....	A-11	4050-15P.....	B-36
4-4 XHX6G5TP.....	B-110	24C.....	A-10	4050-16.....	B-36
5E.....	A-19	24F.....	A-10	4050-16P.....	B-36
5EP.....	A-20	25.....	A-10	4050-29BSPP	B-36
5F.....	A-19	25C.....	A-10	4050-2P.....	B-36
6-4 LHL6G5TP.....	B-110	25F.....	A-10	4050-2P-T8M.....	B-36
6-4 XHX6G5TP.....	B-110	25KAAN13MPN (RF-251-4MP)A-29		4050-3P.....	B-36
8-4 LHL6G5TP.....	B-110	25KAAN17MPN (RF-251-6MP)A-29		4050-4.....	B-36
8-4 XHX6G5TP.....	B-110	25KAIN13MPN (RF-251-4FP) .	A-29	4050-4P.....	B-36
8C.....	A-19	25KAIN17MPN (RF-251-6FP) .	A-29	4050-5.....	B-36
8CP.....	A-20	25KATF06MPN (RF-251-4HB) A-29		4050-5P.....	B-36
9C.....	A-19	25KATF10MPN (RF-251-6HB) A-29		4050-6P.....	B-36
9CP.....	A-20	25KATP06MPN (RF-251-4PL) A-29		4050P-T6.....	B-36
10-4 LHL6G5TP.....	B-110	25KATP10MPN (RF-251-6PL) A-29		4050-T6.....	B-36
10-4 XHX6G5TP.....	B-110	25SFAN13SXZ (RF-254-4MP) A-30		4110-5.....	B-36
12-4 LHL6G5TP.....	B-110	25SFAN17SXZ (RF-254-6MP) A-30		4118005.....	B-14
12-4 XHX6G5TP.....	B-110	25SFIN13SXZ (RF-254-4FP)...	A-30	4118006.....	B-14
14.....	A-20	25SFIN17SXZ (RF-254-6FP)...	A-30	4118007.....	B-11
14-4 LHL6G5TP.....	B-110	25SFTF06SXZ (RF-254-4HB) .	A-30	4128002.....	B-11
14-5B.....	A-21	25SFTF10SXZ (RF-254-6HB) .	A-30	4138001.....	B-14
14-5BP.....	A-21	25SFTP06SXN (RF-254-4PL) .	A-30	4148001.....	B-11
14-6B.....	A-21	25SFTP10SXN (RF-254-6PL) .	A-30	4148002.....	B-14
14C.....	A-20	32-4 LHL6G5TP	B-110	4150-5.....	B-36
14F.....	A-20	1141-62.....	B-84	4158001.....	B-11
15.....	A-20	1141-63.....	B-84	4250-15.....	B-39
15C.....	A-20	1163-60.....	B-88	4250-15P.....	B-39
15F.....	A-20	1163-61.....	B-88	4250-3P.....	B-39
16.....	A-10, A-20	2600.....	E-17	4250-4.....	B-39
16-4 LHL6G5TP.....	B-110	2625.....	E-17	4250-4P.....	B-39
16-4 XHX6G5TP.....	B-110	2650.....	E-17	50001-013-0010.....	B-11
16-5B.....	A-11, A-21	2676.....	E-17	50001-015-0010.....	B-11
16-5BP.....	A-11, A-21	30KAAN13SPN (HF-371-4MP)A-17		50001-112-0010.....	B-14
16-6B.....	A-11, A-21	30KAAN17SPN (HF-371-6MP)A-17		50001-113-0260.....	B-37
16-6BP.....	A-11, A-21	30KAAN21SPN (HF-371-8MP)A-17		50001-114-0296.....	B-82
16-7B.....	A-11, A-21	30KAIN13SPN (HF-371-4FP)..	A-17	50001-115-0010.....	B-14
16E.....	A-10, A-20	30KAIN17SPN (HF-371-6FP)..	A-17	50001-116-0010.....	B-11
16G.....	A-10, A-20	30KAIN21SPN (HF-371-8FP)..	A-17	50001-116-0260.....	B-37, B-39
17.....	A-10, A-20	30KATF10SPN (HF-371-6HB) .	A-17	50001-123-0010.....	B-14
17E.....	A-10, A-20	30KATF13SPN (HF-371-8HB) .	A-17	50001-124-0010.....	B-11
17G.....	A-10, A-20	30KATP10SPN (HF-371-6PL) .	A-17	50001-126-0010.....	B-14
20-4 LHL6G5TP.....	B-110	30KATP13SPN (HF-371-8PL) .	A-17	50001-133-0010.....	B-11
20-4 XHX6G5TP.....	B-110	3005-2.....	B-82	50001-138-0260.....	B-11
21KAAN10MPN (HF-121-2MP)A-16		3005-3.....	B-82	50001-210-0296.....	B-82
21KAAN13MPN (HF-121-4MP)A-16		3009-2.....	B-82	50001-211-0010.....	B-14
21KAIN10MPN (HF-121-2FP) .	A-16	3009-3.....	B-82	50001-211-0260.B-37, B-39, B-71, B-73	
21KAIN13MPN (HF-121-4FP) .	A-16	3010-2.....	B-82	50001-213-0010.....	B-11
21SFAN10MXN (HF-124-2MP)A-16		3010-3.....	B-82	50001-215-0010.....	B-37
21SFAN13MXN (HF-124-4MP)A-16		3010-3-230.....	B-82	50001-218-0010.....	B-11
21SFIN10MXN (HF-124-2FP) .	A-16	3050-2.....	B-82	50001-218-0260.....	B-37



Appendix

Part Number Index

Part Number	Page	Part Number	Page	Part Number	Page
50001-222-0010.....	B-11	6105-20.....	B-67	6608-8-10.....	B-14
50001-224-0010.....	B-11	6105-24.....	B-67	6610-10-10.....	B-14
50001-234-0260.....	B-11	6107-08.....	B-67	6610-12-10.....	B-14
50001-333-0010.....	B-11	6107-16.....	B-67	6610-12-12.....	B-14
50005-211-0200.....	B-69	6107-20.....	B-67	6610-16-16.....	B-14
5005-4.....	B-37, B-38, B-69, B-73	6107-24.....	B-67	6610-6-6.....	B-14
5009-4.....	B-37, B-38, B-69, B-73	6108-08.....	B-66	6610-8-10.....	B-14
50-140-4.....	B-14	6108-16.....	B-66	6657-12M.....	B-15
5050-4.....	B-73	6108-20.....	B-66	6657-16M.....	B-15
5205-2M.....	B-37	6108-24.....	B-66	6659-12M.....	B-15
5205-3M.....	B-37, B-38	6109-08.....	B-66	6659-16M.....	B-15
5205-4M...B-14, B-37, B-38, B-69, B-73		6109-16.....	B-66	71-1C32-24EF.....	B-79
5205-4M-BU...B-37, B-38, B-69, B-73		6109-20.....	B-66	71-1C32-24F.....	B-79
5205-4M-GR...B-37, B-38, B-69, B-73		6109-24.....	B-66	71-1C32-32EF.....	B-79
5205-4M-RE...B-37, B-38, B-69, B-73		6110-08.....	B-66	71-1C32-32F.....	B-79
5205-4M-YE...B-37, B-38, B-69, B-73		6110-12.....	B-66	71-3C12-12EF.....	B-79
5205-5M.....	B-37	6110-16.....	B-66	71-3C12-12F.....	B-79
5205-6M.....	B-37	6110-20.....	B-66	71-3C16-16EF.....	B-79
5209-2M.....	B-37	6110-24.....	B-66	71-3C16-16F.....	B-79
5209-3M.....	B-37, B-38	6115-08.....	B-67	71-3C16-20EF.....	B-79
5209-4M...B-14, B-37, B-38, B-69, B-73		6115-12.....	B-67	71-3C16-20F.....	B-79
5209-4M-BU...B-37, B-38, B-69, B-73		6115-16.....	B-67	71-3C4-4EF.....	B-79
5209-4M-GR...B-37, B-38, B-69, B-73		6115-20.....	B-67	71-3C4-4F.....	B-79
5209-4M-RE...B-37, B-38, B-69, B-73		6115-24.....	B-67	71-3C6-4F.....	B-79
5209-4M-YE...B-37, B-38, B-69, B-73		6120-08.....	B-66	71-3C6-6EF.....	B-79
5209-5M.....	B-37	6120-12.....	B-66	71-3C6-6F.....	B-79
5209-6M.....	B-37	6120-16.....	B-66	71-3C6-8F.....	B-79
59-1001-16FO.....	B-60	6120-20.....	B-66	71-3C8-8EF.....	B-79
59-1001-16FP.....	B-60	6120-24.....	B-66	71-3C8-8F.....	B-79
59-1002-16FO.....	B-60	6125-08.....	B-67	71-3N12-12EF.....	B-80
59-1002-16FP.....	B-60	6125-12.....	B-67	71-3N12-12F.....	B-80
5910DC-01.....	B-60	6125-16.....	B-67	71-3N16-16EF.....	B-80
5910DP-01.....	B-60	6125-20.....	B-67	71-3N16-16F.....	B-80
59-1501-20FO.....	B-60	6125-24.....	B-67	71-3N16-20EF.....	B-80
59-1501-20FP.....	B-60	6130-08.....	B-66	71-3N16-20F.....	B-80
59-1501-24FO.....	B-60	6130-12.....	B-66	71-3N4-4EF.....	B-80
59-1501-24FP.....	B-60	6130-16.....	B-66	71-3N4-4F.....	B-80
59-1502-20FO.....	B-60	6130-20.....	B-66	71-3N6-4F.....	B-80
59-1502-20FP.....	B-60	6130-24.....	B-66	71-3N6-6EF.....	B-80
59-1502-24FO.....	B-60	6135-08.....	B-67	71-3N6-6F.....	B-80
59-1502-24FP.....	B-60	6135-12.....	B-67	71-3N6-8F.....	B-80
5915DC-01.....	B-60	6135-16.....	B-67	71-3N8-8EF.....	B-80
5915DP-01.....	B-60	6135-20.....	B-67	71-3N8-8F.....	B-80
59-501-8FO.....	B-60	6135-24.....	B-67	71-3PCC-12.....	B-79
59-501-8FP.....	B-60	6601-12-10.....	B-14	71-3PCC-16.....	B-79
59-502-8FO.....	B-60	6601-12-12.....	B-14	71-3PCC-4.....	B-79
59-502-8FP.....	B-60	6601-16-16.....	B-14	71-3PCC-6.....	B-79
595DC-01.....	B-60	6601-2-4.....	B-14	71-3PCC-8.....	B-79
595DP-01.....	B-60	6601-4-4.....	B-14	71-3PNC-12.....	B-79
59-751-12FO.....	B-60	6601-6-6.....	B-14	71-3PNC-16.....	B-79
59-751-12FP.....	B-60	6601-8-10.....	B-14	71-3PNC-4.....	B-79
59-752-12FO.....	B-60	6602-12-10.....	B-14	71-3PNC-6.....	B-79
59-752-12FP.....	B-60	6602-12-12.....	B-14	71-3PNC-8.....	B-79
597DC-01.....	B-60	6602-16-16.....	B-14	71N32-24EF.....	B-80
597DP-01.....	B-60	6602-2-4.....	B-14	71N32-24F.....	B-80
6100-08.....	B-66	6602-4-4.....	B-14	71N32-32F.....	B-80
6100-12.....	B-66	6602-6-6.....	B-14	75C12-12F.....	B-76
6100-16.....	B-66	6602-8-10.....	B-14	75C12-12F-DBP.....	B-76
6100-20.....	B-66	6608-10-10.....	B-14	75C12-SPK.....	B-75
6100-24.....	B-66	6608-12-10.....	B-14	75C16-16F.....	B-76
6105-08.....	B-67	6608-12-12.....	B-14	75C16-16F-DBP.....	B-76
6105-12.....	B-67	6608-16-16.....	B-14	75C16-SPK.....	B-75
6105-16.....	B-67	6608-6-6.....	B-14	75C20-20F.....	B-76



Appendix

Part Number Index

Part Number	Page	Part Number	Page	Part Number	Page
75C20-20F-DBP	B-76	9250-4-320	B-71	B16	A-10, A-20
75C20-SPK	B-75	9250-6-320	B-71	B17	A-10, A-20
75C24-24F	B-76	9507-4-1	B-71	B20-3B	A-11
75C24-24F-DBP	B-76	A2C	A-24	B20-3BP	A-11
75C24-SPK	B-75	A3C	A-24	B20-4B	A-11
75C32-32F	B-76	A8C	A-24	B20-5B	A-11
75C32-32F-DBP	B-76	A8CP	A-24	B20-5BP	A-11
75C32-SPK	B-75	ADCE-12	B-29	B22	A-10
75C40-40F	B-76	ADCE-4	B-29	B22A	A-10
75C40-SPK	B-75	ADCE-6	B-29	B22E	A-10
75C48-48F	B-76	ADCE-8	B-29	B23	A-10
75C64-SPK	B-75	ADCH-12	B-25	B23A	A-10
75MDC-12	B-75	ADCH-16	B-25	B23E	A-10
75MDC-16	B-75	ADCH-20	B-25	B24	A-10
75MDC-20	B-75	ADCH-24	B-25	B25	A-10
75MDC-24	B-75	ADCH-32	B-25	B2C	A-19
75MDC-32	B-75	ADCH-4	B-25	B30-3B	A-14
75MDC-40	B-75	ADCH-40	B-25	B30-3BP	A-14
75MDC-64	B-75	ADCH-48	B-25	B30-4B	A-14
75MDP-12	B-75	ADCH-6	B-25	B30-5B	A-14
75MDP-16	B-75	ADCH-8	B-25	B30-5BP	A-14
75MDP-20	B-75	AMPE-12	B-29	B32	A-13
75MDP-24	B-75	AMPE-4	B-29	B32A	A-13
75MDP-32	B-75	AMPE-6	B-29	B32E	A-13
75MDP-40	B-75	AMPE-8	B-29	B33	A-13
75MDP-64	B-75	AMPH-12	B-25	B33A	A-13
75N12-12F	B-76	AMPH-16	B-25	B33E	A-13
75N12-12F-DBP	B-76	AMPH-20	B-25	B34	A-13
75N12-SPK	B-75	AMPH-24	B-25	B34-5B	A-14
75N16-16F	B-76	AMPH-32	B-25	B34-5BP	A-14
75N16-16F-DBP	B-76	AMPH-4	B-25	B34-6B	A-14
75N16-SPK	B-75	AMPH-40	B-25	B34C	A-13
75N20-20F	B-76	AMPH-48	B-25	B34F	A-13
75N20-20F-DBP	B-76	AMPH-6	B-25	B35	A-13
75N20-SPK	B-75	AMPH-8	B-25	B35C	A-13
75N24-24F	B-76	APHC4-4F	B-19	B35F	A-13
75N24-24F-DBP	B-76	APHC6-6F	B-19	B36	A-13
75N24-SPK	B-75	APHN4-4F	B-22	B36-6B	A-14
75N32-32F	B-76	APHN4-4M	B-24	B36-6BP	A-14
75N32-32F-DBP	B-76	APHN6-6F	B-22	B36-7B	A-14
75N32-SPK	B-75	AVHC4-4F	B-19	B36E	A-13
75N40-40F	B-76	AVHC4-4M	B-20	B36G	A-13
75N40-SPK	B-75	AVHC6-6F	B-19	B37	A-13
75N48-48F	B-76	AVHC6-6M	B-20	B37E	A-13
75N64-SPK	B-75	AVHC8-8F	B-19	B37G	A-13
7820123	B-93	AVHN4-4F	B-22	B38	A-13
8010-15 B-36, B-39, B-69, B-71, B-73		AVHN4-4M	B-24	B38-7B	A-14
8010-15P... B-36, B-39, B-69, B-71		AVHN6-6F	B-22	B38-8B	A-14
8010-15P-DC	B-39	AVHN6-6M	B-24	B38J	A-13
8010-16.... B-36, B-69, B-71, B-73		AVHN8-8F	B-22	B39	A-13
8010-16P..... B-36, B-69, B-71		B10-3B	A-21	B39F	A-13
8010-29BSPP	B-36	B10-3BP	A-21	B39J	A-13
8010-4B-36, B-39, B-69, B-71, B-73		B10-4B	A-21	B3C	A-19
8010-4P.... B-36, B-39, B-69, B-71		B10-5B	A-21	B50-3BP	A-24
8010-4P-DC	B-39	B10-5BP	A-21	B50-5BP	A-24
8010-5	B-36	B12	A-20	B52	A-24
8010-5P	B-36	B12A	A-20	B52E	A-24
8250-15	B-69	B12E	A-20	B53	A-24
8250-16	B-69	B13	A-20	B53E	A-24
8250-4	B-69	B13A	A-20	B72	A-27
9250-15-320	B-71	B13E	A-20	B73	A-26
9250-16-320	B-71	B14	A-20	BH12-60L	B-8
9250-334	B-71	B15	A-20	BH12-60N	B-8



Appendix

Part Number Index

Part Number	Page	Part Number	Page	Part Number	Page
BH12-61L	B-10	BPGFN6-6F	A-42	BVEAC6-6M	B-28
BH12-61N	B-10	BPHC12-12F	B-19	BVEAC8-8F	B-28
BH1-60	B-8	BPHC16-16F	B-19	BVEAC8-8M	B-28
BH1-61	B-10	BPHC20-20F	B-19	BVEAN12-12F	B-29
BH2016-60	B-8	BPHC4-4F	B-19	BVEAN12-12M	B-29
BH2016-61	B-10	BPHC6-6F	B-19	BVEAN6-6F	B-29
BH2020-60	B-8	BPHC8-8F	B-19	BVEAN6-6M	B-29
BH2020-61	B-10	BPHN12-12F	B-22	BVEAN8-8F	B-29
BH2024-60	B-8	BPHN12-12M	B-24	BVEAN8-8M	B-29
BH2024-61	B-10	BPHN16-16F	B-22	BVGF-1C12-12F	A-42
BH2-60	B-8	BPHN16-16M	B-24	BVGF-1C8-8F	A-42
BH2-60-STM	B-12	BPHN20-20F	B-22	BVGFC16-16F	A-42
BH2-61	B-10	BPHN24-24F	B-22	BVGFC20-20F	A-42
BH2-61-STM	B-12	BPHN32-32F	B-22	BVGFC4-4F	A-42
BH2C	A-7	BPHN4-2F	B-22	BVGFC6-6F	A-42
BH2E	A-7	BPHN4-2M	B-24	BVHC12-12F	B-19
BH2F	A-7	BPHN4-4F	B-22	BVHC12-12M	B-20
BH2G	A-7	BPHN4-4M	B-24	BVHC16-16M	B-20
BH3-60	B-7	BPHN6-6F	B-22	BVHC20-20F	B-19
BH3-61	B-10	BPHN6-6M	B-24	BVHC4-4F	B-19
BH3C	A-6	BPHN8-8F	B-22	BVHC4-4M	B-20
BH3E	A-6	BPHN8-8M	B-24	BVHC6-6F	B-19
BH3F	A-6	BPN251F	B-94	BVHC6-6M	B-20
BH4-60	B-8	BPN252F	B-94	BVHC8-8F	B-19
BH4-60-STM	B-12	BPN253F	B-94	BVHC8-8M	B-20
BH4-61	B-10	BPN352F	B-94	BVHN12-12F	B-22
BH4-61-STM	B-12	BPN353F	B-94	BVHN12-12M	B-24
BH5G	A-7	BPV252	B-94	BVHN16-16F	B-22
BH6-60	B-8	BPV353	B-94	BVHN16-16M	B-24
BH6-60-STM	B-12	BST-1	B-86	BVHN20-20F	B-22
BH6-61	B-10	BST-10	B-86	BVHN24-24F	B-22
BH6-61-STM	B-12	BST-12	B-86	BVHN32-32F	B-22
BH67E-60K	B-11	BST-1M	B-86	BVHN4-4F	B-22
BH67E-61K	B-11	BST-2	B-86	BVHN4-4M	B-24
BH67F-60K	B-11	BST-2M	B-86	BVHN6-6F	B-22
BH67F-61K	B-11	BST-3	B-86	BVHN6-6M	B-24
BH67G-60K	B-11	BST-3M	B-86	BVHN8-8F	B-22
BH67G-61K	B-11	BST-4	B-86	BVHN8-8M	B-24
BH67J-60K	B-11	BST-4M	B-86	C-25	B-32
BH67J-61K	B-11	BST-6	B-86	C-50	B-32
BH8-60	B-8	BST-6M	B-86	C-75	B-32
BH8-60-STM	B-12	BST-8	B-86	CFE-1002-PN	B-52
BH8-61	B-10	BST-8M	B-86	CFE-252-PN	B-52
BH8-61-STM	B-12	BST-N1	B-87	CFE-372-PN	B-52
BH8CP	A-8	BST-N10	B-87	CFE-502-PN	B-52
BPD3167	B-102	BST-N10M	B-87	CFE-622-PN	B-52
BPD323Y	B-101	BST-N12	B-87	CFE-752-PN	B-52
BPD343Y	B-101	BST-N12M	B-87	CPIFF-12S	E-14
BPDFS341	B-109	BST-N1M	B-87	CPIFF-16S	E-14
BPDFS343	B-109	BST-N2	B-87	CPIFF-2P	E-14
BPEAC12-12F	B-28	BST-N2M	B-87	CPIFF-3P	E-14
BPEAC4-4F	B-28	BST-N3	B-87	CPIFF-4P	E-14
BPEAC6-6F	B-28	BST-N3M	B-87	CPIFF-6P	E-14
BPEAC8-8F	B-28	BST-N4	B-87	CPIFF-8P	E-14
BPEAN12-12F	B-29	BST-N4M	B-87	CPIFF-8S	E-14
BPEAN4-4F	B-29	BST-N6	B-87	CR-25	B-31
BPEAN6-6F	B-29	BST-N6M	B-87	CV-1000-MFMF	E-10
BPEAN8-8F	B-29	BST-N8	B-87	CV-1000-MOMS	E-10
BPGF-1N12-12F	A-42	BST-N8M	B-87	CV-250-MFMF	E-10
BPGF-1N8-8F	A-42	BVEAC12-12F	B-28	CV-250-MOMS	E-10
BPGFN16-16F	A-42	BVEAC12-12M	B-28	CV-370-MFMF	E-10
BPGFN20-20F	A-42	BVEAC4-4F	B-28	CV-370-MOMS	E-10
BPGFN4-4F	A-42	BVEAC6-6F	B-28	CV-500-MFMF	E-10

Appendix

Part Number Index

Part Number	Page	Part Number	Page	Part Number	Page
CV-500-MOMS	E-10	DT-750-MFMF	E-5	FEM-371-6FP-NL	B-51
CV-620-MFMF	E-10	DT-750-MFMO	E-5	FEM-371-8FO-NL	B-51
CV-620-MOMS	E-10	DT-750-MOMF	E-6	FEM-372-6FP	B-52
CV-750-MFMF	E-10	DT-750-MOMS	E-6	FEM-372-8FO	B-52
CV-750-MOMS	E-10	DT-750-MSMO	E-7	FEM-501-10BMF-NL	B-51
DC-1000	E-12	DT-750-MSMS	E-7	FEM-501-10BMS-NL	B-51
DC-1000-FOFO	E-12	EA12-58A	B-27	FEM-501-10FO-NL	B-51
DC-1250	E-12	EA4-58AS	B-27	FEM-501-12FO-NL	B-51
DC-1250-FOFO	E-12	EA8-58V	B-27	FEM-501-8FO-NL	B-51
DC-1500	E-12	EMA3/1/4ED	B-107	FEM-501-8FP-NL	B-51
DC-1500-FOFO	E-12	EMA3/1/4NPT	B-106	FEM-502-10BMF	B-52
DC-2000	E-12	EMA3/1/4NPT71	B-106	FEM-502-10BMS	B-52
DC-2000-FOFO	E-12	EMA3/1/8ED	B-107	FEM-502-10FO	B-52
DC-250	E-12	EMA3/1/8NPT	B-106	FEM-502-12FO	B-52
DC-250-FOFO	E-12	EMA3/10X1ED	B-107	FEM-502-8FO	B-52
DC-370	E-12	EMA3/12X1.5ED	B-107	FEM-502-8FP	B-52
DC-370-FOFO	E-12	EMA3/14X1.5ED	B-107	FEM-621-12FO-NL	B-51
DC-50	B-31	EMA3/3/8ED	B-107	FEM-622-12FO	B-52
DC-500	E-12	EMA3/7/16-20UNF-2A	B-106	FEM-751-12FO-NL	B-51
DC-500-FOFO	E-12	EMA3/9/16-18UNF-2A	B-106	FEM-751-12FP-NL	B-51
DC-750	E-12	EMA3/M8X1OR	B-107	FEM-752-12FO	B-52
DC-750-FOFO	E-12	EMA3VS	B-107	FEM-752-12FP	B-52
DM-121-2FP	B-97	EZ-251-4FP	A-41	FET-1001-20FO	B-62
DM-121-2MP	B-97	EZ-251-4HB	A-41	FET-1001-20FP	B-62
DM-121-4FP	B-97	EZ-251-4MP	A-41	FET-1001-20SF	B-63
DM-121-4MP	B-97	EZ-251-4PL	A-41	FET-1001-20SFP	B-63
DM-122-2FP	B-97	EZ-251-6FP	A-41	FET-1002-20FO	B-63
DM-122-2MP	B-97	EZ-251-6HB	A-41	FET-1002-20FP	B-63
DM-122-4FP	B-97	EZ-251-6MP	A-41	FET-1002-20SF	B-64
DM-122-4MP	B-97	EZ-251-6PL	A-41	FET-1002-20SFP	B-64
DP-50	B-31	EZ-371-6FP	A-41	FET10DC-01	B-64
DT-1000-MFMF	E-5	EZ-371-6HB	A-41	FET10DP-01	B-64
DT-1000-MFMO	E-5	EZ-371-6MP	A-41	FET-1501-24FO	B-62
DT-1000-MOMF	E-6	EZ-371-6PL	A-41	FET-1501-24FP	B-62
DT-1000-MOMS	E-6	EZ-371-8FP	A-41	FET-1501-24SF	B-63
DT-1000-MSMO	E-7	EZ-501-12FP	A-41	FET-1501-24SFP	B-63
DT-1000-MSMS	E-7	EZ-501-8FP	A-41	FET-1502-24FO	B-63
DT-1250-MFMF	E-5	EZ-501-8HB	A-41	FET-1502-24FP	B-63
DT-1250-MFMO	E-5	EZ-501-8MP	A-41	FET-1502-24SF	B-64
DT-1250-MOMF	E-6	EZ-501-8PL	A-41	FET-1502-24SFP	B-64
DT-1250-MOMS	E-6	EZ-751-12FP	A-41	FET15DC-01	B-64
DT-1250-MSMO	E-7	EZ-751-12MP	A-41	FET15DP-01	B-64
DT-1250-MSMS	E-7	FC-751-16FP	A-41	FET-2001-32FO	B-62
DT-250-MOMF	E-6	FC-372-6FP	B-49	FET-2001-32FP	B-62
DT-250-MOMS	E-6	FC-372-8FO	B-49	FET-2002-32FO	B-63
DT-370-MFMF	E-5	FC-372-8FP	B-49	FET-2002-32FP	B-63
DT-370-MFMO	E-5	FC-502-10FO	B-49	FET20DC-01	B-64
DT-370-MOMF	E-6	FC-502-8FP	B-49	FET20DP-01	B-64
DT-370-MOMS	E-6	FC-752-12FO	B-49	FET-371-8FO	B-62
DT-370-MSMO	E-7	FC-752-12FP	B-49	FET-371-8FP	B-62
DT-370-MSMS	E-7	FEC-502-10FO	B-53	FET-372-8FO	B-63
DT-500-MFMF	E-5	FEC-502-12FO	B-53	FET-372-8FP	B-63
DT-500-MFMO	E-5	FEC-502-8FP	B-53	FET3DC-01	B-64
DT-500-MOMF	E-6	FEC-622-12FO	B-53	FET3DP-01	B-64
DT-500-MOMS	E-6	FEC-752-12FO	B-53	FET-501-10FO	B-62
DT-500-MSMO	E-7	FEM-1001-16FO-NL	B-51	FET-501-8FP	B-62
DT-500-MSMS	E-7	FEM-1001-16FP-NL	B-51	FET-502-10FO	B-63
DT-620-MFMF	E-5	FEM-1002-16FO	B-52	FET-502-8FP	B-63
DT-620-MFMO	E-5	FEM-1002-16FP	B-52	FET5DC-01	B-64
DT-620-MOMF	E-6	FEM-251-4FP-NL	B-51	FET5DP-01	B-64
DT-620-MOMS	E-6	FEM-251-6FO-NL	B-51	FET-621-12FO	B-62
DT-620-MSMO	E-7	FEM-252-4FP	B-52	FET-621-12FP	B-62
DT-620-MSMS	E-7	FEM-252-6FO	B-52	FET-622-12FO	B-63



Appendix

Part Number Index

Part Number	Page	Part Number	Page	Part Number	Page
FET-622-12FP	B-63	FF-751-KIT	B-48	H0E	A-7
FET6DC-01	B-64	FF-751-KIT-E4	B-48	H0F	A-7
FET6DP-01	B-64	FF-751-KIT-E5	B-48	H1-05-12MP	E-18
FET-751-16FO	B-62	FF-752-12FO	B-47	H1-05-16MP	E-18
FET-751-16FP	B-62	FF-752-12FP	B-47	H1-05-6MP	E-18
FET-751-16SF	B-63	FF-752-KIT	B-48	H1-20-12MP	E-18
FET-751-16SFP	B-63	FF-752-KIT-E4	B-48	H12-56-9	B-18
FET-752-16FO	B-63	FF-752-KIT-E5	B-48	H12-62L	B-8
FET-752-16FP	B-63	FH-371-6FB	B-55	H12-62N	B-8
FET-752-16SF	B-64	FH-371-6FP	B-55	H12-62-T20	B-8
FET-752-16SFP	B-64	FH-371-6MP	B-55	H12-62-T24	B-8
FET7DC-01	B-64	FH-372-6FB	B-55	H12-63L	B-10
FET7DP-01	B-64	FH-372-6FP	B-55	H12-63N	B-10
FF/FS-1001-TOOL	B-48	FR-1001	B-48, B-57	H12-63-T20	B-10
FF/FS-1001-TOOL	B-58	FR-1002	B-48, B-57	H12-63-T24	B-10
FF/FS-251-TOOL	B-48	FR-25	B-48, B-57	H12-65	B-11
FF/FS-371-TOOL	B-58	FR-501	B-48, B-57	H12-66	B-11
FF/FS-751-TOOL	B-48	FR-502	B-48, B-57	H1-62	B-8
FF/FS-751-TOOL	B-58	FR-751	B-48, B-57	H1-62-T4	B-8
FF-1001-16FO	B-47	FR-752	B-48, B-57	H1-63	B-10
FF-1001-16FP	B-47	FS-1001-16FO	B-57	H1-63-T4	B-10
FF-1001-KIT	B-48	FS-1001-16FP	B-57	H1-65	B-11
FF-1001-KIT-E4	B-48	FS-1001-KIT	B-58	H16-56-9	B-18
FF-1001-KIT-E5	B-48	FS-1001-KIT-E5	B-58	H1-65M	B-11, B-15
FF-1002-16FO	B-47	FS-1002-16FO	B-57	H1-66	B-11
FF-1002-16FP	B-47	FS-1002-16FP	B-57	H1-66M	B-11, B-15
FF-1002-KIT	B-48	FS-1002-KIT	B-58	H1C	A-6
FF-1002-KIT-E4	B-48	FS-1002-KIT-E5	B-58	H1E	A-6
FF-1002-KIT-E5	B-48	FS-251-4FP	B-57	H1F	A-6
FF-251-4FP	B-47	FS-251-4MP	B-57	H2016-62	B-8
FF-251-4MP	B-47	FS-251-6FO	B-57	H2016-63	B-10
FF-251-6FO	B-47	FS-252-4FP	B-57	H2020-62	B-8
FF-251-KIT	B-48	FS-252-4MP	B-57	H2020-63	B-10
FF-251-KIT-E4	B-48	FS-252-6FO	B-57	H2024-62	B-8
FF-251-KIT-E5	B-48	FS-252-KIT	B-58	H2024-63	B-10
FF-252-4FP	B-47	FS-252-KIT-E5	B-58	H20-55	B-18
FF-252-4MP	B-47	FS-371-6FP	B-57	H20-56-9	B-18
FF-252-6FO	B-47	FS-371-8FO	B-57	H20P-65	B-11
FF-252-KIT	B-48	FS-371-E5	B-58	H20P-66	B-11
FF-252-KIT-E4	B-48	FS-371-KIT	B-58	H24-55	B-18
FF-252-KIT-E5	B-48	FS-372-6FP	B-57	H2-62	B-8
FF-371-6FB	B-47	FS-372-8FO	B-57	H2-62-T6	B-8
FF-371-6FP	B-47	FS-372-KIT	B-58	H2-63	B-10
FF-371-8FB	B-47	FS-372-KIT-E5	B-58	H2-63-T6	B-10, B-71
FF-371-8FO	B-47	FS-501-10FO	B-57	H2-65	B-11
FF-371-8FP	B-47	FS-501-8FP	B-57	H2-65M	B-11
FF-371-KIT	B-47	FS-501-KIT	B-58	H2-66	B-11
FF-371-KIT-E4	B-47	FS-501-KIT-E5	B-58	H2-66M	B-11
FF-371-KIT-E5	B-47	FS-501-TOOL	B-58	H2C	A-7
FF-372-6FB	B-47	FS-502-10FO	B-57	H2C-E	A-7
FF-372-6FP	B-47	FS-502-8FP	B-57	H2E	A-7
FF-372-8FB	B-47	FS-502-KIT	B-58	H2E-F	A-7
FF-372-8FO	B-47	FS-502-KIT-E5	B-58	H2F	A-7
FF-372-8FP	B-47	FS-751-12FO	B-57	H2F-G	A-7, A-19
FF-372-KIT	B-48	FS-751-12FP	B-57	H2G	A-7
FF-372-KIT-E4	B-48	FS-751-KIT	B-58	H2G-F	A-7
FF-372-KIT-E5	B-48	FS-751-KIT-E5	B-58	H2G-J	A-7
FF-501-10FO	B-47	FS-752-12FO	B-57	H32-55	B-18
FF-501-8FP	B-47	FS-752-12FP	B-57	H3-62	B-8
FF-502-10FO	B-47	FS-752-KIT	B-58	H3-62-T8	B-8
FF-502-8FP	B-47	FS-752-KIT-E5	B-58	H3-63	B-10
FF-751-12FO	B-47	H00E	A-7	H3-63-T8	B-10
FF-751-12FP	B-47	H0C	A-7	H3-65	B-11

Appendices



Appendix

Part Number Index

Part Number	Page	Part Number	Page	Part Number	Page
H3-65M	B-11	H8-65	B-11	NS-1002-16FB	B-41
H3-66	B-11	H8-65M	B-11	NS-1002-16FO	B-41
H3-66M	B-11	H8-66	B-11	NS-1002-16FP	B-41
H3-68	B-12	H8-66M	B-11	NS-371-6FB	B-41
H3-69	B-12	H8C	A-7	NS-371-6FP	B-41
H3C	A-6	H8C-D	A-7	NS-371-8FO	B-41
H3C-E	A-6	H8CP	A-8	NS-372-6FB	B-41
H3E	A-6	H9C	A-7	NS-372-6FP	B-41
H3E-F	A-6	H9CP	A-8	NS-372-8FO	B-41
H3F	A-6	HM1-05-12MP	E-18	NS-501-10FO	B-41
H3F-G	A-6, A-19	HM1-10-12MP	E-18	NS-501-8FB	B-41
H3G	A-6	HM1-10-6MP	E-18	NS-501-8FP	B-41
H3G-F	A-6	HM1-15-12MP	E-18	NS-502-10FO	B-41
H3G-J	A-6	HO-251-4FP	B-89	NS-502-8FB	B-41
H4-56-9	B-18	HO-252-4FP	B-89	NS-502-8FP	B-41
H4-62	B-8	HO-371-6FP	B-89	NS-751-12FB	B-41
H4-62-T10	B-8	HO-372-6FP	B-89	NS-751-12FO	B-41
H4-63	B-10	HO-501-8FP	B-89	NS-751-12FP	B-41
H4-63-T10	B-10	HO-502-8FP	B-89	NS-752-12FB	B-41
H4-65	B-11	HP-1001-16FO	B-34	NS-752-12FO	B-41
H4-65M	B-11	HP-1001-16FP	B-34	NS-752-12FP	B-41
H4-66	B-11	HP-1002-16FO	B-34	NSS-371-6BMA	B-43
H4-66M	B-11	HP-1002-16FP	B-34	NSS-371-6FO	B-43
H4EP	A-8	HP-1501-24FO	B-34	NSS-371-6HB	B-43
H4F	A-7, A-19	HP-1501-24FP	B-34	NSS-371-6HMA	B-44
H4FP	A-8, A-20	HP-1502-24FO	B-34	NSS-371-6MA	B-43
H5E	A-7	HP-1502-24FP	B-34	NSS-371-8FO	B-43
H5EP	A-8	HPC-100	B-34	NSS-371-8HB	B-43
H5F	A-7	HPC-150	B-34	NSS-371-8MA	B-43
H5F-G	A-7, A-19	HPP-100	B-34	NSS-372-6BMA	B-45
H5FP	A-8, A-20	HPP-150	B-34	NSS-372-6FO	B-44
H5G	A-7	KEY-BK	B-111	NSS-372-6HB	B-44
H5G-F	A-7	KEY-BU	B-111	NSS-372-6HMA	B-45
H5G-J	A-7	KEY-CL	B-111	NSS-372-6MA	B-45
H6-56-9	B-18	KEY-GR	B-111	NSS-372-8FO	B-44
H6-62	B-8	KEY-NI	B-111	NSS-372-8HB	B-44
H6-62-T12	B-8	KEY-RD	B-111	NSS-372-8MA	B-45
H6-63	B-10	L2C	A-27	NSS-501-10FO	B-43
H6-63-T12	B-10	L3C	A-27	NSS-501-12BMA	B-43
H6-65	B-11	MAV1/4NPTMA3CF	B-107	NSS-501-12FO	B-43
H6-65M	B-11	MAV1/4NPTMA3KMCF	B-107	NSS-501-12HB	B-43
H6-66	B-11	MAVMD1/4NPTMA3CF	B-107	NSS-501-12HMA	B-44
H6-66M	B-11	MCE-12	B-29	NSS-501-12MA	B-43
H67A-28	B-11	MCE-4	B-29	NSS-501-8BMA	B-43
H67C-28	B-11	MCE-6	B-29	NSS-501-8HB	B-43
H67E-62K	B-11	MCE-8	B-29	NSS-501-8HMA	B-44
H67E-63K	B-11	MCH-12	B-25	NSS-501-8MA	B-43
H67F-62K	B-11	MCH-16	B-25	NSS-502-10FO	B-44
H67F-63K	B-11	MCH-20	B-25	NSS-502-12BMA	B-45
H67G-62K	B-11	MCH-24	B-25	NSS-502-12FO	B-44
H67G-63K	B-11	MCH-32	B-25	NSS-502-12HB	B-44
H67J-62K	B-11	MCH-4	B-25	NSS-502-12HMA	B-45
H67J-63K	B-11	MCH-40	B-25	NSS-502-12MA	B-45
H68E-67K	B-12	MCH-48	B-25	NSS-502-8BMA	B-45
H69E-67K	B-12	MCH-6	B-25	NSS-502-8HB	B-44
H6E	A-7	MCH-8	B-25	NSS-502-8HMA	B-45
H6EP	A-8	NR-100	B-40	NSS-502-8MA	B-45
H6FP	A-8	NR-37	B-40, B-48, B-55, B-57	P200-9A	B-93
H8-56-9	B-18	NR-50	B-40, B-48, B-55, B-57	P200-9AY	B-93
H8-62	B-8	NR-75	B-40	P201-01A	B-92
H8-62-T16	B-8	NS-1001-16FB	B-41	P208-01A	B-92
H8-63	B-10	NS-1001-16FO	B-41	P-25	B-32
H8-63-T16	B-10	NS-1001-16FP	B-41	P300-11S	B-93



Appendix

Part Number Index

Part Number	Page	Part Number	Page	Part Number	Page
P300-6.....	B-93	PC308.....	B-91	PD36BTL.....	B-103
P300-9A	B-93	PC308-BP	B-91	PD36BTX.....	B-103
P300-9AY	B-93	PC308V	B-91	PD386.....	B-102
P301-01A	B-92	PC308V-BP	B-91	PD38BTL.....	B-103
P308-01A	B-92	PC316.....	B-92	PD38BTX.....	B-103
P308-01A-HF	B-92	PC316-BP*.....	B-92	PD397.....	B-102
P-50.....	B-32	PC316V	B-92	PDC-12.....	B-25, B-29
P500-9A	B-93	PC316V-BP	B-92	PDC-16.....	B-25
P500-9AY	B-93	PC318.....	B-92	PDC-4.....	B-25, B-29
P-75.....	B-32	PC318-BP	B-92	PDC-6.....	B-25, B-29
PBH-251-4FP.....	A-37	PC318V	B-92	PDC-8.....	B-25, B-29
PBH-251-4MP.....	A-37	PC318V-BP	B-92	PDFS242	B-109
PBH-251-6FP.....	A-37	PC326.....	B-91	PDFS-PROBE	B-109
PBH-251-6MP.....	A-37	PC326-BP	B-91	PDH-19.....	B-108
PBH-371-4FP.....	A-37	PC326V	B-91	PDH-32.....	B-108
PBH-371-4MP.....	A-37	PC326V-BP	B-91	PDH-120.....	B-108
PBH-371-6FP.....	A-37	PC328.....	B-91	PDH-240.....	B-108
PBH-371-6MP.....	A-37	PC328-BP	B-91	PDP-12.....	B-25, B-29
PBH-371-8FP.....	A-37	PC328V	B-91	PDP-16.....	B-25
PBS-251-4FP.....	A-39	PC328V-BP	B-91	PDP242	B-105
PBS-251-4MP.....	A-39	PC500.....	B-92	PDP288	B-108
PBS-251-6FP.....	A-39	PC504.....	B-91	PDP323	B-105
PBS-251-6MP.....	A-39	PC504-BP	B-91	PDP341	B-105
PBS-371-6FP.....	A-39	PC506.....	B-91	PDP343	B-105
PBS-371-6MP.....	A-39	PC506-BP	B-91	PDP34BTL	B-105
PBS-371-8FP.....	A-39	PC514.....	B-92	PDP34BTX	B-105
PBS-371-8MP.....	A-39	PC514-BP	B-92	PDP361	B-105
PBS-501-12FP.....	A-39	PC516.....	B-92	PDP36BTL	B-105
PBS-501-6FP.....	A-39	PC516-BP	B-92	PDP36BTX	B-105
PBS-501-8FP.....	A-39	PC524.....	B-91	PDP-4.....	B-25, B-29
PBS-501-8MP.....	A-39	PC524-BP	B-91	PDP-6.....	B-25, B-29
PC204.....	B-91	PC526.....	B-91	PDP-8.....	B-25, B-29
PC204AV	B-91	PC526-BP	B-91	PEAC4-4F	B-28
PC204AV-BP	B-91	PD222.....	B-101	PEAC4-4M	B-28
PC204-BP	B-91	PD240.....	B-101	PEAC6-6F	B-28
PC205.....	B-91	PD242.....	B-101	PEAC8-8F	B-28
PC205AV	B-91	PD243.....	B-101	PEAN4-4F	B-29
PC206.....	B-91	PD248.....	B-108	PEAN4-4M	B-29
PC206AV	B-91	PD260.....	B-101	PEAN6-6F	B-29
PC206AV-BP	B-91	PD288.....	B-108	PEAN8-8F	B-29
PC206-BP	B-91	PD3107.....	B-102	PER-251-4FP	A-40
PC214.....	B-92	PD310BTL.....	B-103	PER-251-4MP	A-40
PC214AV	B-92	PD3127.....	B-102	PER-251-6FP	A-40
PC214AV-BP	B-92	PD312BTX.....	B-103	PER-251-6MP	A-40
PC214-BP	B-92	PD3147.....	B-102	PES-251-4MP	A-42
PC215.....	B-92	PD322.....	B-101	PES-251-6FP	A-42
PC215AV	B-92	PD323.....	B-101	PFE-1001-PN.....	B-52
PC216.....	B-92	PD331.....	B-102	PFE-251-PN.....	B-52
PC216AV	B-92	PD341.....	B-102	PFE-371-PN.....	B-52
PC216AV-BP	B-92	PD342.....	B-101	PFE-501-PN.....	B-52
PC216-BP	B-92	PD343.....	B-101	PFE-621-PN.....	B-52
PC224.....	B-91	PD345.....	B-102	PFE-751-PN.....	B-52
PC224AV	B-91	PD346.....	B-102	PHC12-12F	B-19
PC224AV-BP	B-91	PD34BTL.....	B-103	PHC16-16F	B-19
PC224-BP	B-91	PD34BTX.....	B-103	PHC20-20F	B-19
PC226.....	B-91	PD351.....	B-102	PHC24-24F	B-19
PC226AV	B-91	PD355.....	B-102	PHC32-32F	B-19
PC226AV-BP	B-91	PD357.....	B-102	PHC4-4F	B-19
PC226-BP	B-91	PD361.....	B-102	PHC6-6F	B-19
PC306.....	B-91	PD363.....	B-101	PHC8-8F	B-19
PC306-BP	B-91	PD365.....	B-102	PHN12-12F	A-38, B-22
PC306V	B-91	PD366.....	B-102	PHN12-12M	A-38, B-24
PC306V-BP	B-91	PD367C.....	B-102	PHN16-16F	B-22

Appendices



Appendix

Part Number Index

Part Number	Page	Part Number	Page	Part Number	Page
PHN16-16M	B-24	PS1210102-12-12	D-5	PS690310-6-6	D-11
PHN20-20F	B-22	PS1210106-12-12	D-6	PS690502-6-6	D-11
PHN24-24F	B-22	PS1210302-12-12	D-6	PS690503-6-6	D-12
PHN32-32F	B-22	PS1210306-12-12	D-6	PS690507-6-6	D-12
PHN32-32M	B-24	PS1210502-12-12	D-7	PS690510-6-6	D-12
PHN4-2F	B-22	PS1210506-12-12	D-7	PS6A-RPR	D-4
PHN4-2M	B-24	PS121JMJM-12-12	D-7	PS6-RPR	D-4
PHN4-4F	A-35, B-22	PS1290102-12-12	D-8	PS6W-RPR	D-4
PHN4-4M	A-35, B-24	PS1290103-12-12	D-9	PS6Y-RPR	D-4
PHN6-6F	A-35, B-22	PS1290107-12-12	D-9	PS810102-8-8	D-5
PHN6-6M	A-35, B-24	PS1290110-12-12	D-9	PS810106-8-8	D-6
PHN8-8F	A-35, B-22	PS12901JM-12-12	D-10	PS810302-8-8	D-6
PHN8-8M	A-35, B-24	PS1290302-12-12	D-10	PS810306-8-8	D-6
PL-25	B-32	PS1290303-12-12	D-10	PS810502-8-8	D-7
PN250	B-94	PS1290307-12-12	D-11	PS810506-8-8	D-7
PN250-25	B-95	PS1290310-12-12	D-11	PS81JMJM-8-8	D-7
PN250-40	B-95	PS1290502-12-12	D-11	PS890102-8-8	D-8
PN250-55	B-95	PS1290503-12-12	D-12	PS890103-8-8	D-9
PN251	B-94	PS1290507-12-12	D-12	PS890107-8-8	D-9
PN251-25	B-95	PS1290510-12-12	D-12	PS890110-8-8	D-9
PN251-40	B-95	PS12A-RPR	D-4	PS8901JM-8-8	D-10
PN251-55	B-95	PS12-RPR	D-4	PS890302-8-8	D-10
PN251-70	B-95	PS12W-RPR	D-4	PS890303-10-10	D-10
PN251-85	B-95	PS12Y-RPR	D-4	PS890303-8-8	D-10
PN251F	B-94	PS1610102-16-16	D-5	PS890307-8-8	D-11
PN251S	B-94	PS1610106-16-16	D-6	PS890310-8-8	D-11
PN252	B-94	PS1610302-16-16	D-6	PS890502-8-8	D-11
PN252-25	B-95	PS1610306-16-16	D-6	PS890503-10-10	D-12
PN252-40	B-95	PS1610502-16-16	D-7	PS890503-8-8	D-12
PN252-55	B-95	PS1610506-16-16	D-7	PS890507-8-8	D-12
PN252-70	B-95	PS161JMJM-16-16	D-7	PS890510-8-8	D-12
PN252-85	B-95	PS1690102-16-16	D-8	PS8A-RPR	D-4
PN252F	B-94	PS1690103-16-16	D-9	PS8-RPR	D-4
PN252S	B-94	PS1690107-16-16	D-9	PS8W-RPR	D-4
PN253	B-94	PS1690110-16-16	D-9	PS8Y-RPR	D-4
PN253F	B-94	PS16901JM-16-16	D-10	PV-05-12MP	E-19
PN253S	B-94	PS1690302-16-16	D-10	PV-05-8MP	E-19
PN351-25	B-95	PS1690303-16-16	D-10	PV-10-12MP	E-19
PN351-40	B-95	PS1690307-16-16	D-11	PV-20-12MP	E-19
PN351-55	B-95	PS1690310-16-16	D-11	RK-12N	D-34
PN351-70	B-95	PS1690502-16-16	D-11	RK-4/6N	D-34
PN351-85	B-95	PS1690503-16-16	D-12	RK-8N	D-34
PN352	B-94	PS1690507-16-16	D-12	S2102-12-12	D-15
PN352-25	B-95	PS1690510-16-16	D-12	S2102-4-4	D-15
PN352-40	B-95	PS16A-RPR	D-4	S2102-6-6	D-15
PN352-55	B-95	PS16-RPR	D-4	S2102-8-8	D-15
PN352-70	B-95	PS16W-RPR	D-4	S2107-12-12	D-15
PN352-85	B-95	PS16Y-RPR	D-4	S2107-4-4	D-15
PN352F	B-94	PS610102-6-6	D-5	S2107-6-6	D-15
PN352S	B-94	PS610106-6-6	D-6	S2107-8-8	D-15
PN353	B-94	PS610302-6-6	D-6	S22	A-10
PN353-25	B-95	PS610306-6-6	D-6	S2202-12-12	D-15
PN353-40	B-95	PS610502-6-6	D-7	S2202-4-4	D-15
PN353-55	B-95	PS610506-6-6	D-7	S2202-6-6	D-15
PN353-70	B-95	PS61JMJM-6-6	D-7	S2202-8-8	D-15
PN353-85	B-95	PS690102-6-6	D-8	S2207-12-12	D-16
PN353F	B-94	PS690103-6-6	D-9	S2207-4-4	D-16
PN353S	B-94	PS690107-6-6	D-9	S2207-6-6	D-16
PN354	B-94	PS690110-6-6	D-9	S2207-8-8	D-16
PN553	B-94	PS6901JM-6-6	D-10	S23	A-10
PN554	B-94	PS690302-6-6	D-10	S2502-12-12	D-16
PN556	B-94	PS690303-6-6	D-10	S2502-6-6	D-16
PR-25	B-32	PS690307-6-6	D-11	S2502-8-8	D-16



Part Number	Page	Part Number	Page	Part Number	Page
S2507-12-12	D-16	S71-3N16-16EF	B-80	SH6-63	B-10
S2507-6-6	D-16	S71-3N16-16F	B-80	SH6-63-T12	B-10
S2507-8-8	D-16	S71-3N16-20EF	B-80	SH67E-62K	B-11
S2-ACV-03-BHB	C-4	S71-3N16-20F	B-80	SH67E-63K	B-11
S2-ACV-03-HB	C-4	S71-3N4-4EF	B-80	SH67F-62K	B-11
S2-ACV-04-FP	C-4	S71-3N4-4F	B-80	SH67F-63K	B-11
S2-ACV-04-HB	C-4	S71-3N6-6EF	B-80	SH67G-62K	B-11
S2-ACV-04-MP	C-4	S71-3N6-6F	B-80	SH67G-63K	B-11
S2-ANS-03-BHB	C-5	S71-3N8-8EF	B-80	SH67J-62K	B-11
S2-ANS-03-HB	C-5	S71-3N8-8F	B-80	SH67J-63K	B-11
S2-ANS-04-BHB	C-5	S75C12-12F	B-76	SH71-3C12-12F	B-79
S2-ANS-04-FP	C-5	S75C16-16F	B-76	SH71-3C16-16F	B-79
S2-ANS-04-HB	C-5	S75C20-20F	B-76	SH71-3C4-4F	B-79
S2-ANS-04-MP	C-5	S75C24-24F	B-76	SH71-3C6-6EF	B-79
S2-ANV-03-BHB	C-6	S75C32-32F	B-76	SH71-3C6-6F	B-79
S2-ANV-03-HB	C-6	S75C40-40F	B-76	SH71-3C8-8F	B-79
S2-ANV-04-FP	C-6	S75C48-48F	B-76	SH71-3N12-12F	B-80
S2-ANV-04-HB	C-6	S75N12-12F	B-76	SH71-3N16-16F	B-80
S2-ANV-04-MP	C-6	S75N16-16F	B-76	SH71-3N4-4F	B-80
S2-APV-04-FP	C-4	S75N20-20F	B-76	SH71-3N6-6EF	B-80
S2-APV-04-HB	C-5	S75N24-24F	B-76	SH71-3N6-6F	B-80
S2C	A-19	S75N32-32F	B-76	SH71-3N8-8EF	B-80
S6-ACV-04-FP	C-4	S75N40-40F	B-76	SH71-3N8-8F	B-80
S6-ACV-04-HB	C-4	S75N48-48F	B-76	SH8-62	B-9
S6-ACV-04-MP	C-4	SCA-1/2-EMA-3	B-107	SH8-62-T16	B-9
S6-ACV-06-FP	C-4	SCA-1/4-EMA-3CF	B-107	SH8-63	B-11
S6-ACV-06-HB	C-4	SCA-7/16-EMA-3	B-107	SH8-63-T16	B-11
S6-ACV-06-MP	C-4	SH12-62L	B-8	SH8C	A-7
S6-ANS-04-HB	C-5	SH12-62N	B-8	SH9C	A-7
S6-ANS-06-FP	C-5	SH12-62-T20	B-8	SM-251-4FB	B-31
S6-ANS-06-HB	C-5	SH12-62-T24	B-8	SM-251-4FP	B-31
S6-ANS-06-MP	C-5	SH12-63L	B-10	SM-251-6FB	B-31
S6-ANV-04-FP	C-6	SH12-63N	B-10	SM-251-6FO	B-31
S6-ANV-04-HB	C-6	SH12-63-T20	B-10	SM-251-6FP	B-31
S6-ANV-04-MP	C-6	SH12-63-T24	B-10	SM-252-4FB	B-31
S6-ANV-06-FP	C-6	SH1-62	B-8	SM-252-4FP	B-31
S6-ANV-06-HB	C-6	SH1-62-T4	B-8	SM-252-6FB	B-31
S6-ANV-06-MP	C-6	SH1-63	B-10	SM-252-6FO	B-31
S6C12F-F	E-16	SH1-63-T4	B-10	SM-252-6FP	B-31
S6C16F-F	E-16	SH2016-62	B-8	SM-501-12FB	B-31
S6C4F-F	E-16	SH2016-63	B-10	SM-501-12FP	B-31
S6C4F-M	E-16	SH2020-62	B-8	SM-501-8FB	B-31
S6C4M-M	E-16	SH2020-63	B-10	SM-501-8FO	B-31
S6C6F-F	E-16	SH2024-62	B-8	SM-501-8FP	B-31
S6C6F-M	E-16	SH2024-63	B-10	SM-502-12FB	B-31
S6C8F-F	E-16	SH2-62	B-8	SM-502-12FP	B-31
S6C8M-F	E-16	SH2-62-T6	B-8	SM-502-8FB	B-31
S6C8M-M	E-16	SH2-63	B-10	SM-502-8FO	B-31
S71-3C12-12EF	B-79	SH2-63-T6	B-10	SM-502-8FP	B-31
S71-3C12-12F	B-79	SH2C	A-7	SM-751-12FB	B-31
S71-3C16-16EF	B-79	SH2C-E	A-7	SM-751-12FO	B-31
S71-3C16-16F	B-79	SH3-62	B-8	SM-751-12FP	B-31
S71-3C16-20EF	B-79	SH3-62-T8	B-8	SM-751-16FB	B-31
S71-3C16-20F	B-79	SH3-63	B-10	SM-751-16FO	B-31
S71-3C4-4EF	B-79	SH3-63-T8	B-10	SM-751-16FP	B-31
S71-3C4-4F	B-79	SH3C	A-5	SM-752-12FB	B-31
S71-3C6-6EF	B-79	SH3C-E	A-5	SM-752-12FO	B-31
S71-3C6-6F	B-79	SH4-62	B-8	SM-752-12FP	B-31
S71-3C6-8F	B-79	SH4-62-T10	B-8	SM-752-16FB	B-31
S71-3C8-8EF	B-79	SH4-63	B-10	SM-752-16FO	B-31
S71-3C8-8F	B-79	SH4-63-T10	B-10	SM-752-16FP	B-31
S71-3N12-12EF	B-80	SH6-62	B-8	SMA3-1000	B-108
S71-3N12-12F	B-80	SH6-62-T12	B-8	SMA3-200	B-108

Appendix

Part Number Index

Part Number	Page	Part Number	Page	Part Number	Page
SMA3-2000	B-108	SSH6-63Y	B-9	SVHC12-12M	B-21
SMA3-400	B-108	SSH6-63Y-T12	B-9	SVHC16-16F	B-20
SMA3-4000	B-108	SSH67E-62KY	B-11	SVHC16-16M	B-21
SMA3-800	B-108	SSH67E-63KY	B-11	SVHC20-20F	B-20
SPEAC12-12F	B-28	SSH67F-62KY	B-11	SVHC24-24F	B-20
SPEAC4-4F	B-28	SSH67F-63KY	B-11	SVHC32-32F	B-20
SPEAC4-4M	B-28	SSH67G-62KY	B-11	SVHC4-2F	B-20
SPEAN12-12F	B-29	SSH67G-63KY	B-11	SVHC4-4F	B-20
SPEAN4-4F	B-29	SSH67J-62KY	B-11	SVHC4-4M	B-21
SPEAN4-4M	B-29	SSH67J-63KY	B-11	SVHC6-6F	B-20
SPHC12-12F	B-20	SSH8-62Y	B-9	SVHC6-6M	B-21
SPHC16-16F	B-20	SSH8-62Y-T16	B-9	SVHC8-8F	B-20
SPHC20-20F	B-20	SSH8-63Y	B-9	SVHC8-8M	B-21
SPHC24-24F	B-20	SSH8-63Y-T16	B-9	SVHN12-12F	B-23
SPHC32-32F	B-20	SSPD242Y	B-101	SVHN12-12M	B-24
SPHC4-4F	B-20	SSPD343Y	B-101	SVHN16-16F	B-23
SPHC6-6F	B-20	SST-1	B-86	SVHN16-16M	B-24
SPHC8-8F	B-20	SST-1M	B-86	SVHN20-20F	B-23
SPHN12-12F	B-23	SST-2	B-86	SVHN20-20M	B-24
SPHN16-16F	B-23	SST-2M	B-86	SVHN24-24F	B-23
SPHN20-20F	B-23	SST-3	B-86	SVHN32-32F	B-23
SPHN24-24F	B-23	SST-3M	B-86	SVHN4-2F	B-23
SPHN32-32F	B-23	SST-4	B-86	SVHN4-4F	B-23
SPHN4-2F	B-23	SST-4M	B-86	SVHN4-4M	B-24
SPHN4-2M	B-24	SST-6	B-86	SVHN6-6F	B-23
SPHN4-4F	B-23	SST-6M	B-86	SVHN6-6M	B-24
SPHN4-4M	B-24	SST-8	B-86	SVHN8-8F	B-23
SPHN6-6F	B-23	SST-8M	B-86	SVHN8-8M	B-24
SPHN6-6M	B-24	SST-N1	B-87	TC-371	B-83
SPHN8-8F	B-23	SST-N1M	B-87	TC-372	B-83
SPHN8-8M	B-24	SST-N2	B-87	TH-1000-16FO-05	E-21
SSH12-62LY	B-9	SST-N2M	B-87	TH-1000-16FO-10	E-21
SSH12-62NY	B-9	SST-N3	B-87	TH-1000-16FO-13	E-21
SSH12-62Y-T20	B-9	SST-N3M	B-87	TH-1000-16FO-25	E-21
SSH12-62Y-T24	B-9	SST-N4	B-87	TH-1000-16FO-30	E-21
SSH12-63LY	B-9	SST-N4M	B-87	TH-1000-16FO-33	E-21
SSH12-63NY	B-9	SST-N6	B-87	TH-1000-16FO-45	E-21
SSH12-63Y-T20	B-9	SST-N6M	B-87	TH-1000-16FO-50	E-21
SSH12-63Y-T24	B-9	SST-N8	B-87	TH-1000-16FO-53	E-21
SSH1-62Y	B-9	SST-N8M	B-87	TH-1000-16FO-65	E-21
SSH1-62Y-T4	B-9	ST-N1	B-87	TH-1000-16FO-70	E-21
SSH1-63Y	B-9	ST-N1M	B-87	TH-1000-16FO-85	E-21
SSH1-63Y-T4	B-9	ST-N2	B-87	TL-251-4FP	A-32
SSH2016-62Y	B-9	ST-N2M	B-87	TL-251-4MP	A-32
SSH2016-63Y	B-9	ST-N3	B-87	TL-251-6MP	A-32
SSH2020-62Y	B-9	ST-N3M	B-87	TL-254-2FP	A-33
SSH2020-63Y	B-9	ST-N4	B-87	TL-254-2MP	A-33
SSH2024-62Y	B-9	ST-N4M	B-87	TL-254-4FP	A-33
SSH2024-63Y	B-9	ST-N6	B-87	TL-254-4HB	A-33
SSH2-62Y	B-9	ST-N6M	B-87	TL-254-4MP	A-33
SSH2-62Y-T6	B-9	ST-N8	B-87	TL-254-6HB	A-33
SSH2-63Y	B-9	ST-N8M	B-87	TL-501-12FP	A-32
SSH2-63Y-T6	B-9	SVEAC12-12F	B-28	TL-501-6FP	A-32
SSH3-62Y	B-9	SVEAC4-4F	B-28	TL-501-6MP	A-32
SSH3-62Y-T8	B-9	SVEAC8-8F	B-28	TL-501-8FP	A-32
SSH3-63Y	B-9	SVEAC8-8M	B-28	TL-501-8MP	A-32
SSH3-63Y-T8	B-9	SVEAN12-12F	B-29	TL-504-12MP	A-33
SSH4-62Y	B-9	SVEAN4-2F	B-29	TL-504-4FP	A-33
SSH4-62Y-T10	B-9	SVEAN4-4F	B-29	TL-504-4HB	A-33
SSH4-63Y	B-9	SVEAN4-4M	B-29	TL-504-4MP	A-33
SSH4-63Y-T10	B-9	SVEAN8-8F	B-29	TL-504-6FP	A-33
SSH6-62Y	B-9	SVEAN8-8M	B-29	TL-504-6HB	A-33
SSH6-62Y-T12	B-9	SVHC12-12F	B-20	TL-504-6MP	A-33



Part Number	Page	Part Number	Page	Part Number	Page
TL-504-8HB	A-33	VHN4-4F.....	B-22		
TL-504-8MP	A-33	VHN4-4M.....	B-24		
TR-37	B-14, B-83	VHN6-6EM	B-25		
UC-251-4FP	A-25	VHN6-6F.....	B-22		
UC-251-4MP	A-25	VHN6-6M.....	B-24		
UC-251-6FP	A-25	VHN8-8EF	B-22		
UC-251-6MP	A-25	VHN8-8EM	B-25		
VEAC12-12F.....	B-28	VHN8-8F.....	B-22		
VEAC12-12M	B-28	VHN8-8M.....	B-24		
VEAC4-4F.....	B-28	VIHC12-12F.....	A-35		
VEAC4-4M	B-28	VIHC4-4F.....	A-35		
VEAC6-6F.....	B-28	VIHC4-4FSL	A-35		
VEAC6-6M	B-28	VIHC4-4M.....	A-35		
VEAC8-8F.....	B-28	VIHC4-4MSL	A-35		
VEAC8-8M	B-28	VIHC6-6F.....	A-35		
VEAC8-SPK	B-27	VIHC6-6FSL	A-35		
VEAN12-12F.....	B-29	VIHC6-6M.....	A-35		
VEAN12-12M	B-29	VIHC6-6MSL	A-35		
VEAN4-4F.....	B-29	VIHC8-8F.....	A-35		
VEAN4-4M	B-29	VPHC12-12EF	B-21		
VEAN6-6F.....	B-29	VPHC12-12F	B-21		
VEAN6-6M	B-29	VPHC6-6F	B-21		
VEAN8-8F.....	B-29	VPHC8-8F	B-21		
VEAN8-8M	B-29	VPHN8-8EM	B-25		
VEAN8-SPK	B-27	VPHN8-8F	B-25		
VHC12-12EFV	B-19				
VHC12-12EM	B-21				
VHC12-12F.....	B-19				
VHC12-12M.....	B-20				
VHC16-16EF	B-19				
VHC16-16F.....	B-19				
VHC16-16M.....	B-20				
VHC20-20F.....	B-19				
VHC24-24F.....	B-19				
VHC32-32M.....	B-20				
VHC4-2F.....	B-19				
VHC4-2M.....	B-20				
VHC4-4EF	B-19				
VHC4-4EM	B-21				
VHC4-4F.....	B-19				
VHC4-4M.....	B-20				
VHC6-6EF	B-19				
VHC6-6EM	B-21				
VHC6-6F.....	B-19				
VHC6-6M.....	B-20				
VHC8-8EF	B-19				
VHC8-8EM	B-21				
VHC8-8F.....	B-19				
VHC8-8M.....	B-20				
VHN12-12EF	B-22				
VHN12-12EM	B-25				
VHN12-12F.....	B-22				
VHN12-12M.....	B-24				
VHN16-16EF	B-22				
VHN16-16F.....	B-22				
VHN16-16M.....	B-24				
VHN20-20F.....	B-22				
VHN20-20M.....	B-24				
VHN24-24F.....	B-22				
VHN32-32F.....	B-22				
VHN4-2F.....	B-22				
VHN4-2M.....	B-24				
VHN4-4EM	B-25				



WARNING

SAFETY GUIDE FOR SELECTING AND USING QUICK ACTION COUPLINGS AND RELATED ACCESSORIES



WARNING

DANGER: Failure or improper selection or improper use of quick action couplings or related accessories can cause death, personal injury and property damage. Possible consequences of failure or improper selection or improper use of quick action couplings or related accessories include but are not limited to:

- Couplings or parts thrown off at high speed.
- High velocity fluid discharge.
- Explosion or burning of the conveyed fluid.
- Contact with suddenly moving or falling objects that are to be held in position or moved by the conveyed fluid.
- Dangerously whipping hose.
- Contact with conveyed fluids that may be hot, cold, toxic, or otherwise injurious.
- Sparking or explosion while paint or flammable liquid spraying.

Before selecting or using any Parker quick action couplings or related accessories, it is important that you read and follow the following instructions.

1.1 Scope: This safety guide provides instructions for selecting and using (including installing connecting, disconnecting, and maintaining) quick action couplings and related accessories (including caps, plugs, blow guns, and two way valves). This safety guide is a supplement to and is to be used with, the specific Parker publications for the specific quick action couplings and related accessories that are being considered for use.

1.2 Fail-Safe: Quick action couplings or the hose they are attached to can fail without warning for many reasons. Design all systems and equipment in a fail-safe mode, so that failure of the quick action coupling or hose will not endanger persons or property.

1.3 Distribution: Provide a copy of this safety guide to each person that is responsible for selecting or using quick action coupling products. Do not select or use quick action couplings without thoroughly reading and understanding this safety guide as well as the specific Parker publications for the products considered or selected.

1.4 User Responsibility: Due to the wide variety of operating conditions and uses for quick action couplings, Parker and its distributors do not represent or warrant that any particular quick action coupling is suitable for any specific end use system. This safety guide does not analyze all technical parameters that must be considered in selecting a product. The user, through its own analysis and testing, is solely responsible for:

- Making the final selection of the quick action couplings.
- Assuring that the user's requirements are met and that the use presents no health or safety hazards.
- Providing all appropriate health and safety warnings on the equipment on which the quick action couplings are used.

1.5 Additional Questions: Call the appropriate Parker customer service department if you have any questions or require any additional information. For the telephone numbers of the appropriate customer service department, see the Parker publication for the product being considered or used.

2.0 QUICK ACTION COUPLING SELECTION INSTRUCTIONS

2.1 Pressure: Quick action couplings selection must be made so that the published rated pressure of the coupling is equal to or greater than the maximum system pressure. Surge pressures in the system higher than the rated pressure of the coupling will shorten the quick action coupling's life. Do not confuse burst pressure or other pressure values with rated pressure and do not use burst pressure or other pressure values for this purpose.

2.2 Fluid Compatibility: Quick action couplings selection must assure compatibility of the body and seal materials with the fluid media used. See the fluid compatibility chart in the Parker publication for the product being considered or used.

2.3 Temperature: Be certain that fluid and ambient temperatures, both steady and transient, do not exceed the limitations of the quick action couplings. Use caution and hand protection when connecting or disconnecting quick action couplings that are heated or cooled by the media they are conducting or by their environment.

2.4 Size: Transmission of power by means of pressurized liquid varies with pressure and rate of flow. The size of the quick action couplings and other components of the system must be adequate to keep pressure losses to a minimum and avoid damage due to heat generation or excessive fluid velocity.

2.5 Pressurized Connect or Disconnect: If connecting or disconnecting under pressure is a requirement, use only quick action couplings designed for that purpose. The rated operating pressure of a quick action coupling may not be the pressure at which it may be safely connected or disconnected.

2.6 Environment: Care must be taken to ensure that quick action couplings are either compatible with or protected from the environment (that is, surrounding conditions) to which they are exposed. Environmental conditions including but not limited to ultraviolet radiation, ozone, moisture, water, salt water, chemicals, and air pollutants can cause degradation and premature failure.

2.7 Locking Means: Ball locking quick action couplings can unintentionally disconnect if they are dragged over obstructions on the end of a hose or if the sleeve is bumped or moved enough to cause disconnect. Sleeves designed with flanges to provide better gripping for oily or gloved hands are especially susceptible to accidental disconnect and should not be used where these conditions exist. Sleeve lock or union (threaded) sleeve designs should be considered where there is a potential for accidental uncoupling.

2.8 Mechanical Loads: External forces can significantly reduce quick action couplings' life or cause failure. Mechanical loads which must be considered include excessive tensile or side loads, and vibration. Unusual applications may require special testing prior to quick action couplings selection.

2.9 Specifications and Standards: When selecting quick action couplings, government, industry, and Parker specifications must be reviewed and followed as applicable.

2.10 Vacuum: Not all quick action couplings are suitable or recommended for vacuum service. Quick action couplings used for vacuum applications must be selected to ensure that the quick actions couplings will withstand the vacuum and pressure of the system.

2.11 Fire Resistant Fluids: Some fire resistant fluids require seals other than the standard nitrile used in many quick action couplings.

2.12 Radiant Heat: Quick action couplings can be heated to destruction or loss of sealability without contact by such nearby items as hot manifolds or molten metal. The same heat source may then initiate a fire. This can occur despite the presence of cool air around the quick action couplings.

2.13 Welding and Brazing: Heating of plated parts, including quick action couplings and port adapters, above 450°F (232°C) such as during welding, brazing, or soldering may emit deadly gases and may cause coupling seal damage.

3.0 QUICK ACTION COUPLING INSTALLATION INSTRUCTIONS

3.1 Pre-Installation Inspection: Before installing a quick action coupling, visually inspect it and check for correct style, body material, seal material, and catalog number. Before final installation, coupling halves should be connected and disconnected with a sample of the mating half with which they will be used.

3.2 Quick Action Coupling Halves From Other Manufacturers

If a quick action coupling assembly is made up of one Parker half and one half from another manufacturer, the lowest pressure rating of the two halves should not be exceeded.

3.3 Fitting Installation: Use a thread sealant, lubricant, or a combination of both when assembling pipe thread joints in quick action couplings. Be sure the sealant is compatible with the system fluid or gas. To avoid system contamination, use a liquid or paste type sealant rather than a tape style. Use the flats provided to hold the quick action coupling when installing fittings. Do not use pipe wrenches or a vice on other parts of the coupling to hold it when installing or removing fittings as damage or loosening of threaded joints in the coupling assembly could result. Do not apply excessive torque to taper pipe threads because cracking or splitting of the female component can result.

3.4 Caps and Plugs: Use dust caps and plugs when quick action couplings are not coupled to exclude dirt and contamination and to protect critical surfaces from damage.

3.5 Coupling Location: Locate quick action couplings where they can be reached for connect or disconnect without exposing the operator to slipping, falling, getting sprayed, or coming in contact with hot or moving parts.

3.6 Hose Whips: Use a hose whip (a short length of hose between the tool and the coupling half) instead of rigidly mounting a coupling half on hand tools or other devices. This reduces the potential for coupling damage if the tool is dropped and provides some isolation from mechanical vibration which could cause uncoupling.

4.0 QUICK ACTION COUPLING MAINTENANCE INSTRUCTIONS

4.1 Even with proper selection and installation, quick action coupling life may be significantly reduced without a continuing maintenance program. Frequency should be determined by the severity of the application and risk potential. A maintenance program must be established and followed by the user and must include the following as a minimum:

4.2 Visual Inspection of Quick Action Couplings: Any of the following conditions require immediate shut down and replacement of the quick action coupling:

- Cracked, damaged, or corroded quick action coupling parts.
- Leaks at the fitting, valve or mating seal.
- Broken coupling mounting hardware, especially breakaway clamps.

4.3 Visual Inspection All Other: The following items must be tightened, repaired or replaced as required:

- Leaking seals or port connections.
- Remove excess dirt buildup on the coupling locking means or on the interface area of either coupling half.
- Clamps, guards, and shields.
- System fluid level, fluid type and any air entrapment.

4.4 Functional Test: Operate the system at maximum operating pressure and check for possible malfunctions and freedom from leaks. Personnel must avoid potential hazardous areas while testing and using the system.

4.5 Replacement Intervals: Specific replacement intervals must be considered based on previous service life, government or industry recommendations, or when failures could result in unacceptable downtime, damage or injury risk. See instruction 1.2 above.

Additional copies of the preceding safety information can be ordered by requesting "Safety Guide For Selecting and Using Quick Action Couplings and Related Accessories," Parker Publication No. 3800-B1.0

Contact The Quick Coupling Division, Minneapolis, MN.

1. Definitions. As used herein, the following terms have the meanings indicated.

Buyer: means any customer receiving a Quote for Products.

Goods: means any tangible part, system or component to be supplied by Seller.

Products: means the Goods, Services and/or Software as described in a Quote.

Quote: means the offer or proposal made by Seller to Buyer for the supply of Products.

Seller: means Parker-Hannifin Corporation, including all divisions and businesses thereof.

Services: means any services to be provided by Seller.

Software: means any software related to the Goods, whether embedded or separately downloaded.

Terms: means the terms and conditions of this Offer of Sale.

2. Terms. All sales of Products by Seller are expressly conditioned upon, and will be governed by the acceptance of, these Terms. These Terms are incorporated into any Quote provided by Seller to Buyer. Buyer's order for any Products whether communicated to Seller verbally, in writing, by electronic data interface or other electronic commerce, shall constitute acceptance of these Terms. Seller objects to any contrary or additional terms or conditions of Buyer. Reference in Seller's order acknowledgement to Buyer's purchase order or purchase order number shall in no way constitute an acceptance of any of Buyer's terms or conditions of purchase. No modification to these Terms will be binding on Seller unless agreed to in writing and signed by an authorized representative of Seller.

3. Price; Payment. The Products set forth in the Quote are offered for sale at the prices indicated in the Quote. Unless otherwise specifically stated in the Quote, prices are valid for thirty (30) days and do not include any sales, use, or other taxes or duties. Seller reserves the right to modify prices at any time to adjust for any raw material price fluctuations. Unless otherwise specified by Seller, all prices are F.C.A. Seller's facility (INCOTERMS 2020). All sales are contingent upon credit approval and full payment for all purchases is due thirty (30) days from the date of invoice (or such date as may be specified in the Quote). Unpaid invoices beyond the specified payment date incur interest at the rate of 1.5% per month or the maximum allowable rate under applicable law.

4. Shipment; Delivery; Title and Risk of Loss. All delivery dates are approximate, and Seller is not responsible for damages resulting from any delay. Regardless of the manner of shipment, delivery occurs and title and risk of loss or damage pass to Buyer, upon placement of the Products with the carrier at Seller's facility. Unless otherwise agreed prior to shipment and for domestic delivery locations only, Seller will select and arrange, at Buyer's sole expense, the carrier and means of delivery. When Seller selects and arranges the carrier and means of delivery, freight and insurance costs for shipment to the designated delivery location will be prepaid by Seller and added as a separate line item to the invoice. Buyer shall be responsible for any additional shipping charges incurred by Seller due to Buyer's acts or omissions. Buyer shall not return or repackage any Products without the prior written authorization from Seller, and any return shall be at the sole cost and expense of Buyer.

5. Warranty. The warranty for the Products is as follows: (i) Goods are warranted against defects in material or workmanship for a period of twelve (12) months from the date of delivery or 2,000 hours of use, whichever occurs first; (ii) Services shall be performed in accordance with generally accepted practices and using the degree of care and skill that is ordinarily exercised and customary in the field to which the Services pertain and are warranted for a period of six (6) months from the date of completion of the Services; and (iii) Software is only warranted to perform in accordance with applicable specifications provided by Seller to Buyer for ninety (90) days from the date of delivery or, when downloaded by a Buyer or end-user, from the date of the initial download. All prices are based upon the exclusive limited warranty stated above, and upon the following disclaimer: **EXEMPTION CLAUSE; DISCLAIMER OF WARRANTY, CONDITIONS, REPRESENTATIONS; THIS WARRANTY IS THE SOLE AND ENTIRE WARRANTY, CONDITION, AND REPRESENTATION, PERTAINING TO PRODUCTS. SELLER DISCLAIMS ALL OTHER WARRANTIES, CONDITIONS, AND REPRESENTATIONS, WHETHER STATUTORY, EXPRESS OR IMPLIED, INCLUDING BUT NOT LIMITED TO THOSE RELATING TO DESIGN, NON-INFRINGEMENT, MERCHANTABILITY, AND FITNESS FOR A PARTICULAR PURPOSE. SELLER DOES NOT WARRANT THAT THE SOFTWARE IS ERROR-FREE OR FAULT-TOLERANT, OR THAT BUYER'S USE THEREOF WILL BE SECURE OR UNINTERRUPTED. UNLESS OTHERWISE AUTHORIZED IN WRITING BY SELLER, THE SOFTWARE SHALL NOT BE USED IN CONNECTION WITH HAZARDOUS OR HIGH RISK ACTIVITIES OR ENVIRONMENTS. EXCEPT AS EXPRESSLY STATED HEREIN, ALL PRODUCTS ARE PROVIDED "AS IS".**

6. Claims; Commencement of Actions. Buyer shall promptly inspect all Products upon receipt. No claims for shortages will be allowed unless reported to Seller within ten (10) days of delivery. Buyer shall notify Seller of any alleged breach of warranty within thirty (30) days after the date the non-conformance is or should have been discovered by Buyer. Any claim or action against Seller based upon breach of contract or any other theory, including tort, negligence, or otherwise must be commenced within twelve (12) months from the date of the alleged breach or other alleged event, without regard to the date of discovery.

7. LIMITATION OF LIABILITY. IN THE EVENT OF A BREACH OF WARRANTY, SELLER WILL, AT ITS OPTION, REPAIR OR REPLACE THE NON-CONFORMING PRODUCT, RE-PERFORM THE SERVICES, OR REFUND THE PURCHASE PRICE PAID WITHIN A REASONABLE PERIOD OF TIME. IN NO EVENT IS SELLER LIABLE FOR ANY SPECIAL, INDIRECT, INCIDENTAL OR CONSEQUENTIAL DAMAGES INCLUDING ANY LOSS OF REVENUE OR PROFITS, WHETHER BASED IN CONTRACT, TORT OR OTHER LEGAL THEORY. IN NO EVENT SHALL SELLER'S LIABILITY UNDER ANY CLAIM MADE BY BUYER EXCEED THE PURCHASE PRICE PAID FOR THE PRODUCTS.

8. Confidential Information. Buyer acknowledges and agrees that any technical, commercial, or other confidential information of Seller, including, without limitation, pricing, technical drawings or prints and/or part lists, which has been or will be disclosed, delivered or made available, whether directly or indirectly, to Buyer ("Confidential Information"), has been and will be received in confidence and will remain the property of Seller. Buyer further agrees that it will not use Seller's Confidential Information for any purpose other than for the benefit of Seller.

9. Loss to Buyer's Property. Any tools, patterns, materials, equipment or information furnished by Buyer or which are or become Buyer's property ("Buyer's Property"), will be considered obsolete and may be destroyed by Seller after two (2) consecutive years have elapsed without Buyer ordering the Products manufactured using Buyer's Property. Furthermore, Seller shall not be responsible for any loss or damage to Buyer's Property while it is in Seller's possession or control.

10. Special Tooling. "Special Tooling" includes but is not limited to tools, jigs, fixtures and associated manufacturing equipment acquired or necessary to manufacture Goods. Seller may impose a tooling charge for any Special Tooling. Such Special Tooling shall be and remain Seller's property notwithstanding payment of any charges by Buyer. In no event will Buyer acquire any interest in the Special Tooling, even if such Special Tooling has been specially converted or adapted for manufacture of Goods for Buyer and notwithstanding any charges paid by Buyer. Unless otherwise agreed, Seller has the right to alter, discard or otherwise dispose of any Special Tooling or other property owned by Seller in its sole discretion at any time.

11. Security Interest. To secure payment of all sums due from Buyer, Seller retains a security interest in all Products delivered to Buyer and, Buyer's acceptance of these Terms is deemed to be a Security Agreement under the Uniform Commercial Code. Buyer authorizes Seller as its attorney to execute and file on Buyer's behalf all documents Seller deems necessary to perfect Seller's security interest.

12. User Responsibility. Buyer, through its own analysis and testing, is solely responsible for making the final selection of the Products and assuring that all performance, endurance, maintenance, safety and warning requirements of the application of the Products are met. Buyer must analyze all aspects of the application and follow applicable industry standards, specifications, and any technical information provided with the Quote or the Products, such as Seller's instructions, guides and specifications. If Seller provides options of or for Products based upon data or specifications provided by Buyer, Buyer is responsible for determining that such data and specifications are suitable and sufficient for all applications and reasonably foreseeable uses of the Products. In the event Buyer is not the end-user of the Products, Buyer will ensure such end-user complies with this paragraph.

13. Use of Products, Indemnity by Buyer. Buyer shall comply with all instructions, guides and specifications provided by Seller with the Quote or the Products. **Unauthorized Uses.** If Buyer uses or resells the Products in any way prohibited by Seller's instructions, guides or specifications, or Buyer otherwise fails to comply with Seller's instructions, guides and specifications, Buyer acknowledges that any such use, resale, or non-compliance is at Buyer's sole risk. Further, Buyer shall indemnify, defend, and hold Seller harmless from any losses, claims, liabilities, damages, lawsuits, judgments and costs (including attorney fees and defense costs), whether for personal injury, property damage, intellectual property infringement or any other claim, arising out of or in connection with: (a) improper selection, design, specification, application, or any misuse of Products; (b) any act or omission, negligent or otherwise, of Buyer; (c) Seller's use of patterns, tools, equipment, plans, drawings, designs, specifications or other information or things furnished by Buyer; (d) damage to the Products from an external cause, repair or attempted repair by anyone other than Seller, failure to follow instructions, guides and specifications provided by Seller, use with goods not provided by Seller, or opening, modifying, deconstructing, tampering with or repackaging the Products; or (e) Buyer's failure to comply with these Terms. Seller shall not indemnify Buyer under any circumstance except as otherwise provided in these Terms.

14. Cancellations and Changes. Buyer may not cancel or modify, including but not limited to movement of delivery dates for the Products, any order for any reason except with Seller's written consent and upon terms that will indemnify, defend and hold Seller harmless against all direct, incidental and consequential loss or damage and any additional expense. Seller, at any time, may change features, specifications, designs and availability of Products.

15. Limitation on Assignment. Buyer may not assign its rights or obligations without the prior written consent of Seller.

16. Force Majeure. Seller is not liable for delay or failure to perform any of its obligations by reason of events or circumstances beyond its reasonable control. Such circumstances include without limitation: accidents, labor disputes or stoppages, government acts or orders, acts of nature, pandemics, epidemics, other widespread illness, or public health emergency, delays or failures in delivery from carriers or suppliers, shortages of materials, war (whether declared or not) or the serious threat of same, riots, rebellions, acts of terrorism, fire or any reason whether similar to the foregoing or otherwise. Seller will resume performance as soon as practicable after the event of force majeure has been removed. All delivery dates affected by force majeure shall be tolled for the duration of such force majeure and rescheduled for mutually agreed dates as soon as practicable after the force majeure condition ceases to exist. Force majeure shall not include financial distress, insolvency, bankruptcy, or other similar conditions affecting one of the parties, affiliates and/or sub-contractors.

17. Waiver and Severability. Failure to enforce any provision of these Terms will not invalidate that provision; nor will any such failure prejudice either party's right to enforce that provision in the future. Invalidation of any provision of these Terms shall not invalidate any other provision herein and, the remaining provisions will remain in full force and effect.

18. Termination. Seller may terminate any agreement governed by or arising from these Terms for any reason and at any time by giving Buyer thirty (30) days prior written notice. Seller may immediately terminate, in writing, if Buyer: (a) breaches any provision of these Terms, (b) becomes or is deemed insolvent, (c) appoints or has appointed a trustee, receiver or custodian for all or any part of Buyer's property, (d) files a petition for relief in bankruptcy on its own behalf, or (e) is filed against Buyer by a third party, (e) makes an assignment for the benefit of creditors; or (f) dissolves its business or liquidates all or a majority of its assets.

19. Ownership of Software. Seller retains ownership of all Software supplied to Buyer hereunder. In no event shall Buyer obtain any greater right in and to the Software than a right in the nature of a license limited to the use thereof and subject to compliance with any other terms provided with the Software.

20. Indemnity for Infringement of Intellectual Property Rights. Seller is not liable for infringement of any patents, trademarks, copyrights, trade dress, trade secrets or similar rights ("Intellectual Property Rights") except as provided in this Section. Seller will defend at its expense and will pay the cost of any settlement or damages awarded in an action brought against Buyer based on a third party claim that one or more of the Products sold hereunder infringes the Intellectual Property Rights of a third party in the country of delivery of the Products by Seller to Buyer. Seller's obligation to defend and indemnify Buyer is contingent on Buyer notifying Seller within ten (10) days after Buyer becomes aware of any such claim, and Seller having sole control over the defense of the claim including all negotiations for settlement or compromise. If one or more Products sold hereunder is subject to such a claim, Seller may, at its sole expense and option, procure for Buyer the right to continue using the Products, replace or modify the Products so as to render them non-infringing, or offer to accept return of the Products and refund the purchase price less a reasonable allowance for depreciation. Seller has no obligation or liability for any claim of infringement: (i) arising from information provided by Buyer; or (ii) directed to any Products provided hereunder for which the designs are specified in whole or part by Buyer; or (iii) resulting from the modification, combination or use in a system of any Products provided hereunder. The foregoing provisions of this Section constitute Seller's sole and exclusive liability and Buyer's sole and exclusive remedy for claims of infringement of Intellectual Property Rights.

21. Governing Law. These Terms and the sale and delivery of all Products are deemed to have taken place in, and shall be governed and construed in accordance with, the laws of the State of Ohio, as applicable to contracts executed and wholly performed therein and without regard to conflicts of laws principles. Buyer irrevocably agrees and consents to the exclusive jurisdiction and venue of the courts of Cuyahoga County, Ohio with respect to any dispute, controversy or claim arising out of or relating to the sale and delivery of the Products.

22. Entire Agreement. These Terms, along with the terms set forth in the main body of any Quote, forms the entire agreement between the Buyer and Seller and constitutes the final, complete and exclusive expression of the terms of sale and purchase. In the event of a conflict between any term set forth in the main body of a Quote and these Terms, the terms set forth in the main body of the Quote shall prevail. All prior or contemporaneous written or oral agreements or negotiations with respect to the subject matter shall have no effect. These Terms may not be modified unless in writing and signed by an authorized representative of Seller.

23. Compliance with Laws. Buyer agrees to comply with all applicable laws, regulations, and industry and professional standards, including those of the United States of America, and the country or countries in which Buyer may operate, including without limitation the U.S. Foreign Corrupt Practices Act ("FCPA"), the U.S. Anti-Kickback Act ("Anti-Kickback Act"), U.S. and E.U. export control and sanctions laws ("Export Laws"), the U.S. Food Drug and Cosmetic Act ("FDCA"), and the rules and regulations promulgated by the U.S. Food and Drug Administration ("FDA"), each as currently amended. Buyer agrees to indemnify, defend, and hold harmless Seller from the consequences of any violation of such laws, regulations and standards by Buyer, its employees or agents. Buyer acknowledges that it is familiar with all applicable provisions of the FCPA, the Anti-Kickback Act, Export Laws, the FDCA and the FDA and certifies that Buyer will adhere to the requirements thereof and not take any action that would make Seller violate such requirements. Buyer represents and agrees that Buyer will not make any payment or give anything of value, directly or indirectly, to any governmental official, foreign political party or official thereof, candidate for foreign political office, or commercial entity or person, for any improper purpose, including the purpose of influencing such person to purchase Products or otherwise benefit the business of Seller. Buyer further represents and agrees that it will not receive, use, service, transfer or ship any Products from Seller in a manner or for a purpose that violates Export Laws or would cause Seller to be in violation of Export Laws. Buyer agrees to promptly and reliably provide Seller all requested information or documents, including end-user statements and other written assurances, concerning Buyer's ongoing compliance with Export Laws.

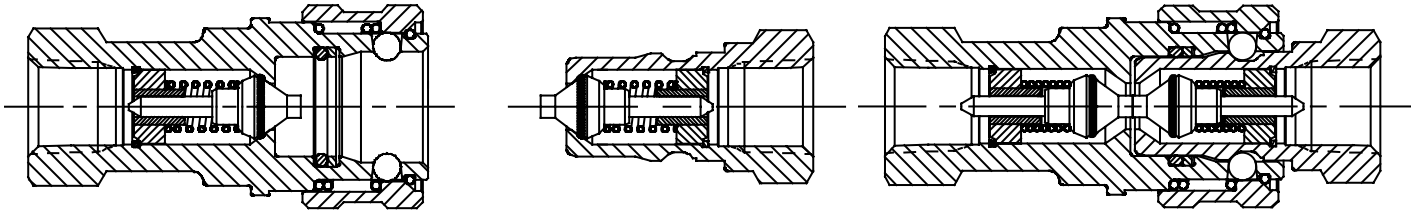

Air Inclusion: The ambient atmosphere forced into the system during the connection of the quick disconnect halves.

Break-Away: Automatic disconnection of a coupling when an axial separation force is applied.

Brinelling: Dimples or grooves worn into the shoulder of a male half by the locking balls in the female half.

Burst Pressure: The pressure at which a device loses the capability to retain pressure.

Case Hardening: Hardening the surface of low carbon steel.

Cold Flow: Continued deformation under load.

Connect Under Pressure: Ability to connect coupling halves with internal line pressure applied to either both sides or one side.

Coupling, Female Half: Other nomenclature "coupler", "socket", "body".

Coupling, Male Half: Other nomenclature "nipple", "plug", "adapter".

Coupling, Quick Disconnect: A component which can quickly join or separate a fluid line without the use of tools or special devices.

Differential Pressure (ΔP): The difference in pressure between any two points of a system or a component.

Double-Acting Sleeve: Permits push-to-connect and pull-to-disconnect convenience on implement line when female half is clamp mounted and connected with a hose.

Dust Cap: Dust or dirt repelling enclosure for both halves.

Dust Plug: Dust or dirt repelling enclosure both halves.

Flow Checking: Occurs when a nipple valve closes during flow conditions, such as when quickly lowering a heavy implement. (Also called Check Off, Back Checking or Lock-up.)

Flush Position (Valve): When the coupler valve is fully open, allowing maximum oil flow.

Force to Connect: Axial and/or rotational force required to make a complete connection.

Force to Disconnect: The reverse of the above.

Induction Hardening: Localized hardening of medium carbon steel.

Peak Pressure: Maximum momentary pressure encountered in the operation of a component.

Pressure Cap: Cap which incorporates a seal capable of withstanding the rated pressures on the male half.

Pressure Impulse Test: Subjecting a component to a specified pressure at a specified rate of increase or decrease for a specified time limit.

Pressure Operating: The pressure at which a system is operated.

Pressure Plug: Plug which incorporates a seal capable of withstanding the rated pressures on the female half.

Proof Pressure: The non-destructive test pressure in excess of the maximum rated operating pressure.

Push To Connect (Auto Lock): Locking arrangement which permits one handed connection by pushing the nipple into the coupler.

Rated Pressure: The maximum pressure at which a product is designed to operate.

Single-Acting Sleeve: Permits pull-to-disconnect convenience on implement line when female body is clamp mounted. Making connection requires manually pulling female body forward, inserting male tip, then allowing body and tip to return to original position in the clamp.

Sleeve Lock: Arrangement which provides an additional lock which must be actuated before the locking sleeve can be retracted.

Spillage: The fluid removed from the system due to disconnection of a coupling assembly. This is the fluid trapped between the mating seal and the valve seal of the coupling halves.

Surge Pressure: The pressure existing from surge conditions.

Surge Flows: A rapid increase in fluid flow.

Thermal Build-Up: Hydraulic pressure caused by expansion of the fluid due to heat from an external source such as sunlight.

Trapped Pressure: Pressurized hydraulic fluid trapped behind closed coupling valve.

Twist Lock: A locking arrangement which requires a rotational actuation to unlock the mating halves.

Types of Quick Disconnect Coupling Valve:

Straight-Thru (ST): This provides straight through flow.

Double Shut-off Valve (DSO): A valve in the female half and a valve in the male half.

Single Shut-off Valve (SSO): Generally, a valve in the female half with no valve in the male half.

NOTE: Refer to Parker's Publication No. 3800-B1.0: Safety Guide for Selecting and Using Quick Action Couplings and Related Accessories.



About Parker Hannifin Corporation

Parker Hannifin is a leading global motion-control company dedicated to delivering premier customer service. A Fortune 500 corporation listed on the New York Stock Exchange (PH), our components and systems comprise over 1,400 product lines that control motion in some 1,000 industrial and aerospace markets. Parker is the only manufacturer to 7,500 distributors serving nearly 400,000 customers worldwide.

Parker's Charter

To be a leading worldwide manufacturer of components and systems for the builders and users of durable goods. More specifically, we will design, market and manufacture products controlling motion, flow and pressure. We will achieve profitable growth through premier customer service.

Product Information

North American customers seeking product information, the location of a nearby distributor, or repair services will receive prompt attention by calling the Parker Product Information Center at our toll-free number: 1-800-C-PARKER (1-800-272-7537). In Europe, call: 00800-C-PARKER-H (00800-2727-5374).

The Aerospace Group is a leader in the development, design, manufacture and servicing of control systems and components for aerospace and related high-technology markets, while achieving growth through premier customer service.



The Climate & Industrial Controls Group designs, manufactures and markets system-control and fluid-handling components and systems to refrigeration, air-conditioning and industrial customers worldwide.



The Fluid Connectors Group designs, manufactures and markets rigid and flexible connectors, and associated products used in pneumatic and fluid systems.



The Seal Group designs, manufactures and distributes industrial and commercial sealing devices and related products by providing superior quality and total customer satisfaction.



The Hydraulics Group designs, produces and markets a full spectrum of hydraulic components and systems to builders and users of industrial and mobile machinery and equipment.



The Filtration Group designs, manufactures and markets quality filtration and clarification products, providing customers with the best value, quality, technical support, and global availability.



The Automation Group is a leading supplier of pneumatic and electromechanical components and systems to automation customers worldwide.



The Instrumentation Group is a global leader in the design, manufacture and distribution of high-quality critical flow components for worldwide process instrumentation, ultra-high-purity, medical and analytical applications.



Parker Fluid Connectors Group

North American Divisions & Distribution Service Centers

Your complete source for quality tube fittings, hose & hose fittings, brass & composite fittings, quick-disconnect couplings, valves and assembly tools, locally available from a worldwide network of authorized distributors.

Fittings:

Available in inch and metric sizes covering SAE, BSP, DIN, GAZ, JIS and ISO thread configurations, manufactured from steel, stainless steel, brass, aluminum, nylon and thermoplastic.

Hose, Tubing and Bundles:

Available in a wide variety of sizes and materials including rubber, wire-reinforced, thermoplastic, hybrid and custom compounds.

Worldwide Availability:

Parker operates Fluid Connectors manufacturing locations and sales offices throughout North America, South America, Europe and Asia-Pacific.

For information, call toll free...

1-800-C-PARKER
(1-800-272-7537)

North American Divisions

Fluid System Connectors Division

Otsego, MI
phone 269 694 9411
fax 269 694 4614

Hose Products Division

Wickliffe, OH
phone 440 943 5700
fax 440 943 3129

Parflex Division

Ravenna, OH
phone 330 296 2871
fax 330 296 8433

Quick Coupling Division

Minneapolis, MN
phone 763 544 7781
fax 763 544 3418

Tube Fittings Division

Columbus, OH
phone 614 279 7070
fax 614 279 7685

Distribution Service Centers

Buena Park, CA

phone 714 522 8840
fax 714 994 1183

Conyers, GA

phone 770 929 0330
fax 770 929 0230

Louisville, KY

phone 502 937 1322
fax 502 937 4180

Portland, OR

phone 503 283 1020
fax 503 283 2201

Toledo, OH

phone 419 878 7000
fax 419 878 7001
fax 419 878 7420
(FCG Kit Operations)

Canada

Milton, ONT

phone 905 693 3000
fax 905 876 1958

Mexico

Toluca, MEX

phone (52) 722 2754 200
fax (52) 722 2722 168



Parker Hannifin Corporation
Quick Coupling Division

8145 Lewis Road
Minneapolis, MN 55427
phone 763 544 7781
fax 763 544 3418

www.parker.com/quickcouplings

