

**PRODUCT SPECIFICATIONS**



Post Office Box 97  
Benton Harbor, Michigan  
Ph: 269/926-6171  
Fax: 269/925-8288

**PART NUMBER:  
STD113A**

**REV.  
A**

Model Number	MAX. PRESS. bar.	PSI	MAX. SPEED RPM	HP	KW	Net Wt. lbs.	kg
ZAM-NCW-7ALL	5,6	80	2,000	.55	0.40	4.2	1.9

**SOUND LEVEL** 76 dba MAX.

**NORMAL AMBIENT** +1°C. - 120°C.

**RELATIVE HUMIDITY** 0% - 100%

**ENVIRONMENT** HAZARDOUS AMBIENT COMBUSTIBLE  
GAS AND DUST +1°C TO +40°C

CONFORMS TO EUROPEAN STANDARD EN13463-1  
NON-ELECTRICAL EQUIPMENT FOR EXPLOSIVE  
ATMOSPHERES GROUP II CAT 2 (GAS & DUST),  
PROTECTED BY CONSTRUCTION (SURFACE TEMP. RATED 135°C).

**NOTES:**

1. CORROSION RESISTANT ROTOR ASSEMBLY.
2. UNIVERSAL VANE MATERIAL FOR OPERATING WITH OR WITHOUT LUBRICATION.
3. TECHNICAL DATA SUBJECT TO CHANGE WITHOUT NOTICE

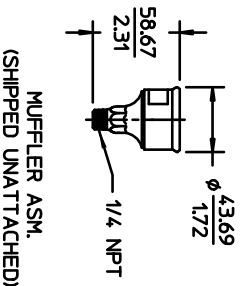
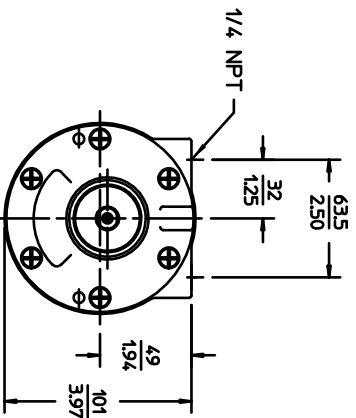
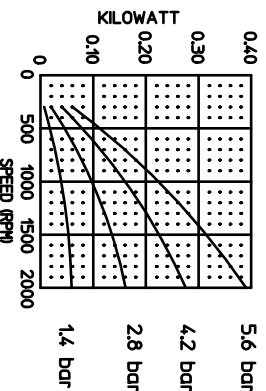
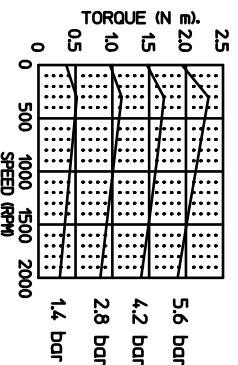
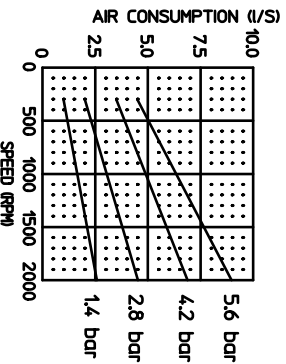
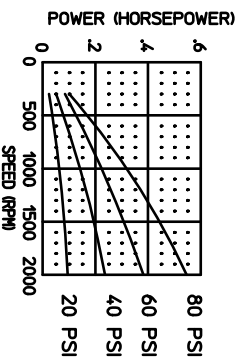
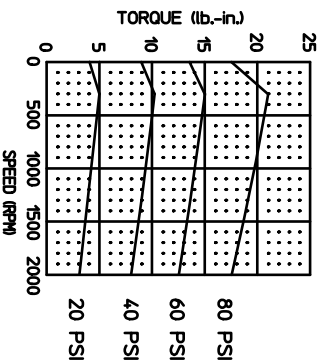
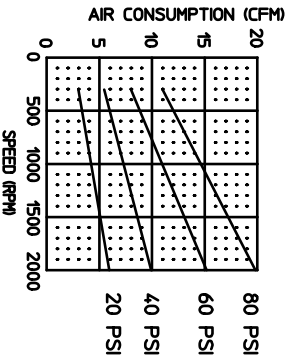

MUFFLER ASM.  
(SHIPPED UNATTACHED)

