

PRODUCT SPECIFICATIONS



Post Office Box 97
Benton Harbor, Michigan
Ph: 269/926-6171
Fax: 269/925-8288

**PART NUMBER:
STD113B**

**REV.
A**

Model Number	MAX. PRESS. bar.	PSI	MAX. SPEED RPM	HP	KW	Net Wt. lbs.	kg
ZAM-NCC-16LL	5,6	80	2,000	.55	0.40	4.2	1.9

SOUND LEVEL 76 dba MAX.

NORMAL AMBIENT +1°C. - 120°C.

RELATIVE HUMIDITY 0% - 100%

ENVIRONMENT HAZARDOUS AMBIENT COMBUSTIBLE
GAS AND DUST +1°C TO +40°C

CONFORMS TO EUROPEAN STANDARD EN13463-1

NON-ELECTRICAL EQUIPMENT FOR EXPLOSIVE
ATMOSPHERES GROUP II CAT 2 (GAS & DUST),
PROTECTED BY CONSTRUCTION (SURFACE TEMP. RATED 135°C).

NOTES:

1. CORROSION RESISTANT ROTOR ASSEMBLY.
2. UNIVERSAL VANE MATERIAL FOR OPERATING WITH OR WITHOUT LUBRICATION.
3. TECHNICAL DATA SUBJECT TO CHANGE WITHOUT NOTICE

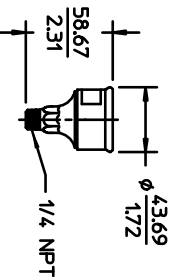
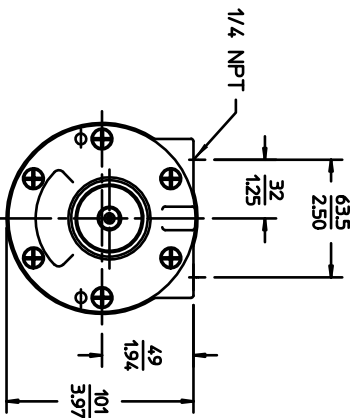
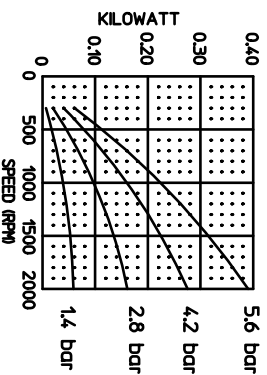
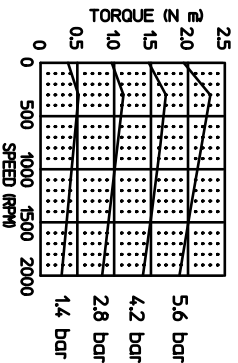
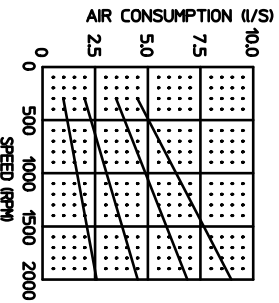
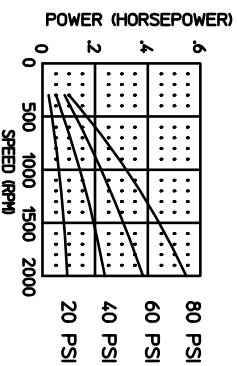
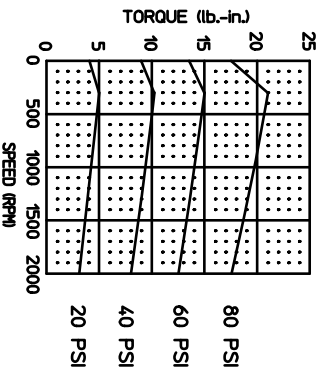
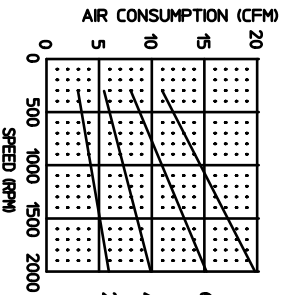

MUFFLER ASM,
(SHIPPED UNATTACHED)

