

Post Office Box 97  
 Benton Harbor, Michigan  
 Ph: 269/926-6171  
 Fax: 269/925-8288

PART NUMBER: STD119  
 REVISION: G

# Product Specifications

Model Number	MAX. PRESS.		MAX. SPEED	HP	kW	Net Wt.	
	bar.	PSI				lbs.	kg
2AM-ARV-92	7.0	100	3,000 RPM	.95	0.70	7.5	3.4

SOUND LEVEL 76 dB(A) MAX.  
 NORMAL AMBIENT +1°C. - 120°C.  
 RELATIVE HUMIDITY 0% - 100%  
 ENVIRONMENT HAZARDOUS AMBIENT COMBUSTIBLE  
GAS AND DUST +1°C TO +40°C

CONFORMS TO EUROPEAN STANDARD PREN13463-1  
 NON-ELECTRICAL EQUIPMENT FOR EXPLOSIVE  
 ATMOSPHERES GROUP II CAT 2 (GAS & DUST),  
 PROTECTED BY CONSTRUCTION  
 (SURFACE TEMP. RATED 135°C).

\* TECHNICAL DATA SUBJECT TO CHANGE  
 WITHOUT NOTICE.

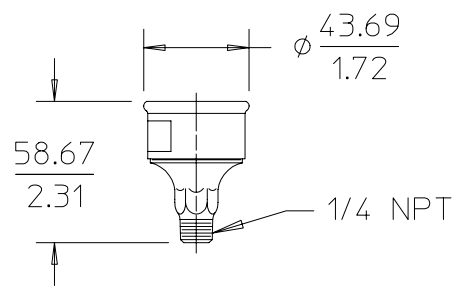
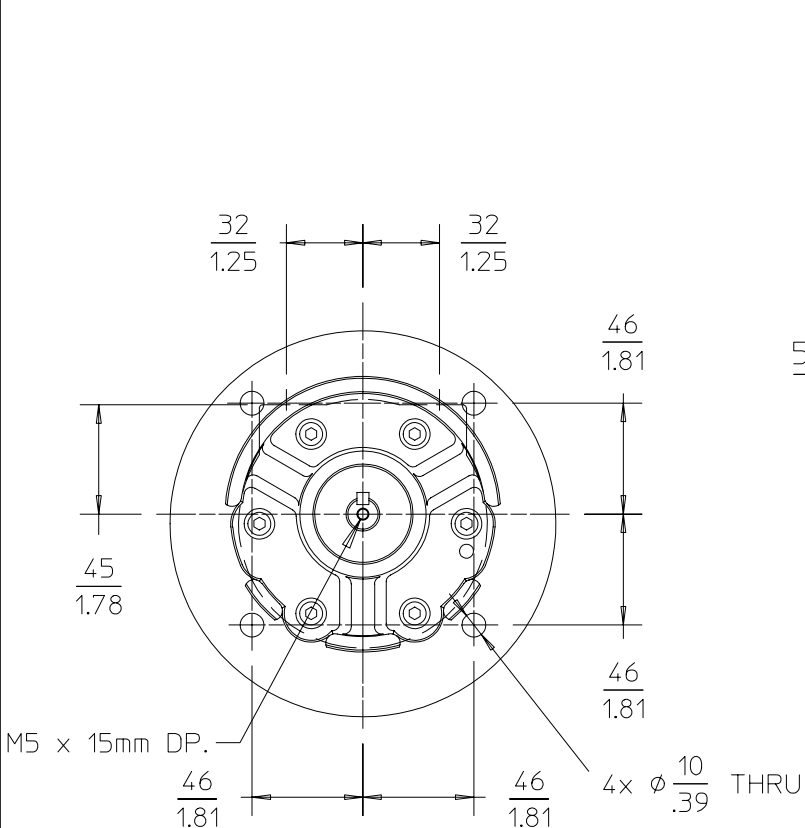
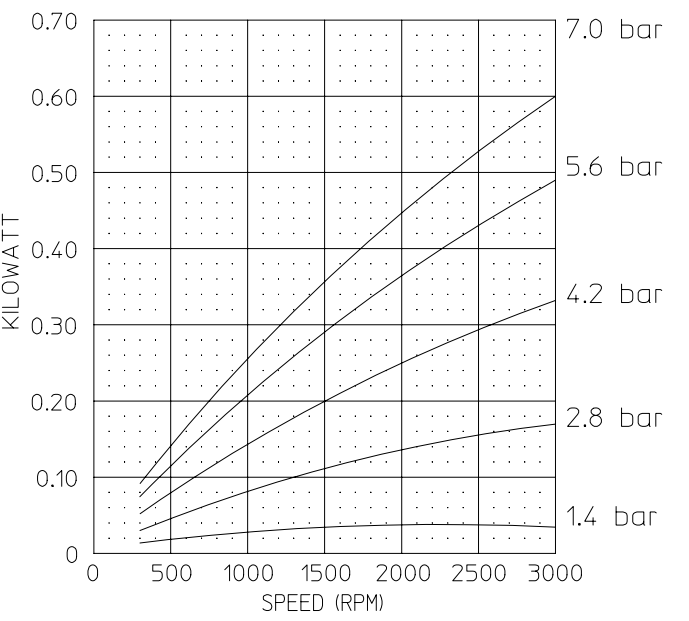
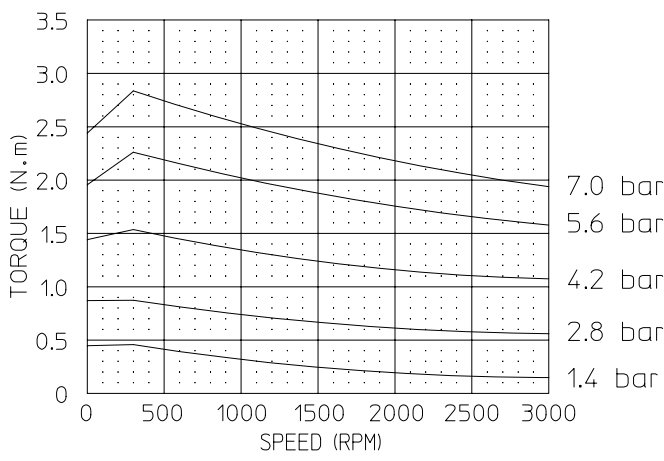
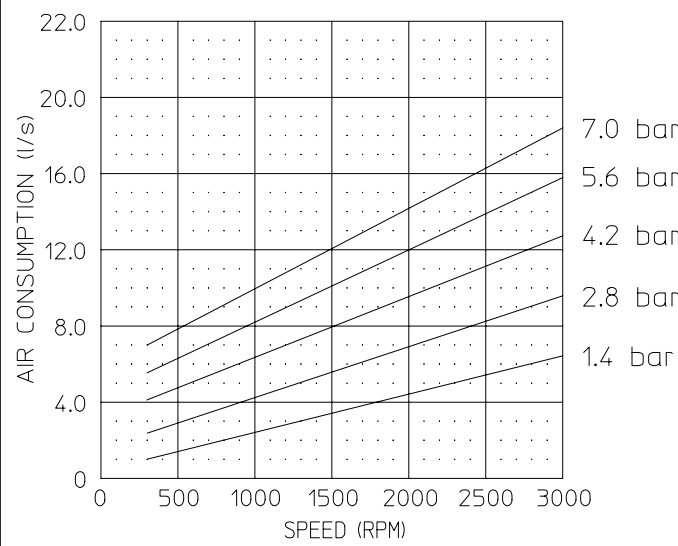
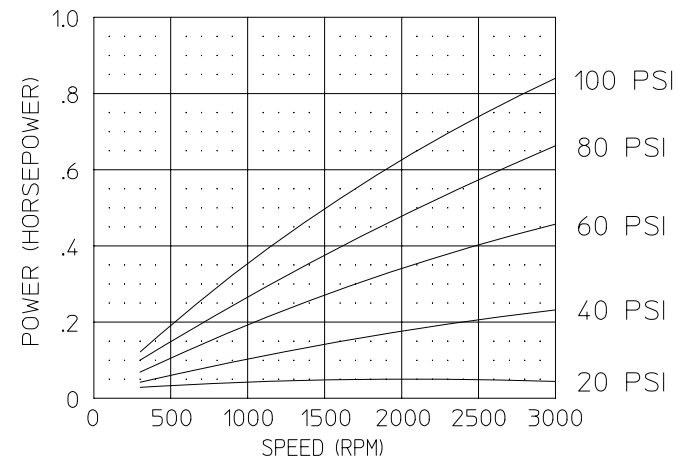
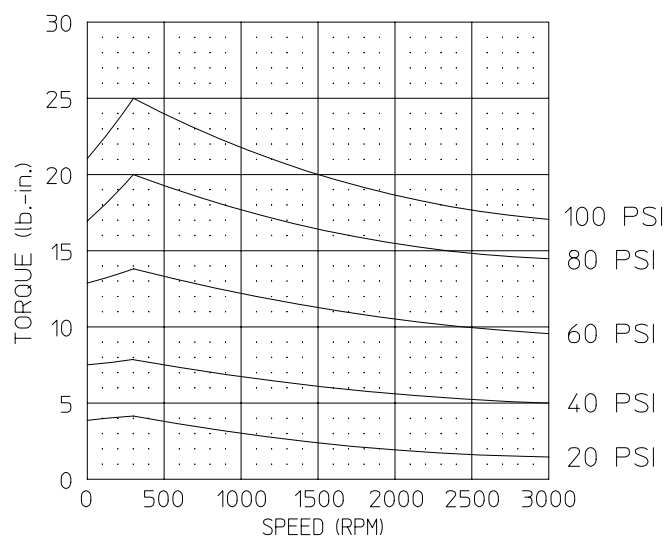
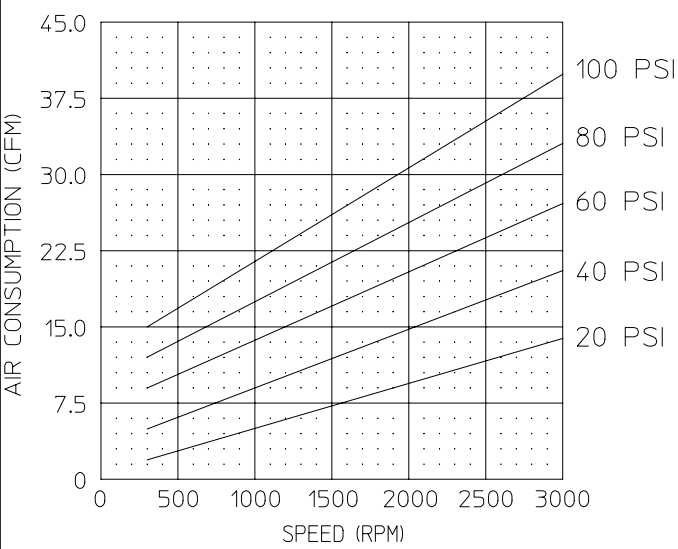

MUFFLER ASM.  
 (SHIPPED UNATTACHED)

