



Post Office Box 97  
 Benton Harbor, Michigan  
 Ph: 269/926-6171  
 Fax: 269/925-8288

PART NUMBER: STD125  
 REVISION: E

# Product Specifications

Model Number	MAX. PRESS.		MAX. SPEED	HP	kW	Net Wt.	
	bar.	PSI				lbs.	kg
4AM-RV-75	7.0	100	3,000 RPM	1.7	1.25	11	5.0

CONFORMS TO EUROPEAN STANDARD EN13463-1 NON-ELECTRICAL EQUIPMENT FOR EXPLOSIVE ATMOSPHERES GROUP II CAT 2 (GAS & DUST), PROTECTED BY CONSTRUCTION T4 (TEMP RATED 135°C)

SOUND LEVEL 87 dB(A) MAX.  
 NORMAL AMBIENT +1°C. - 40°C.  
 RELATIVE HUMIDITY 0% - 100%  
 ENVIRONMENT HAZARDOUS AMBIENT COMBUSTIBLE GAS AND DUST

TECHNICAL DATA SUBJECT TO CHANGE WITHOUT NOTICE.

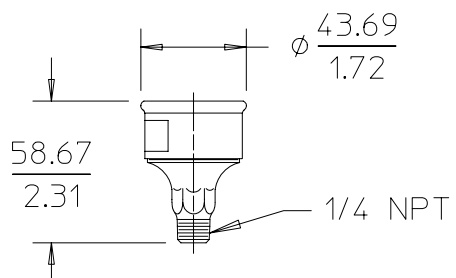
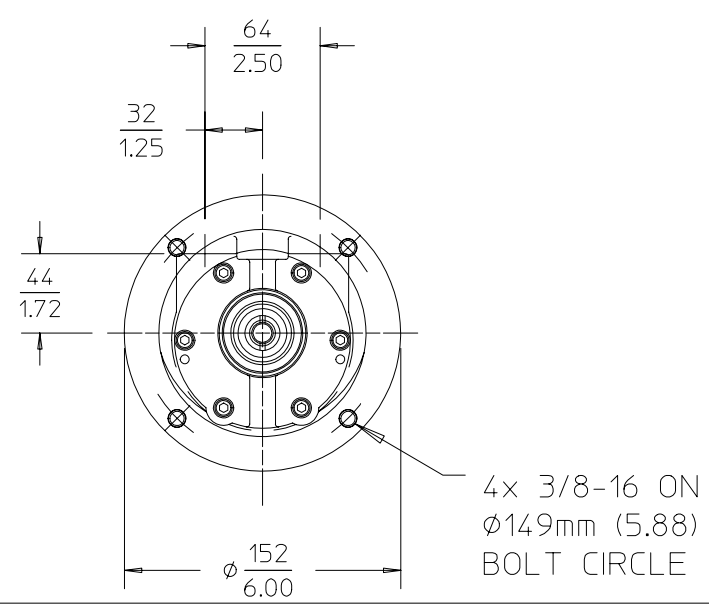
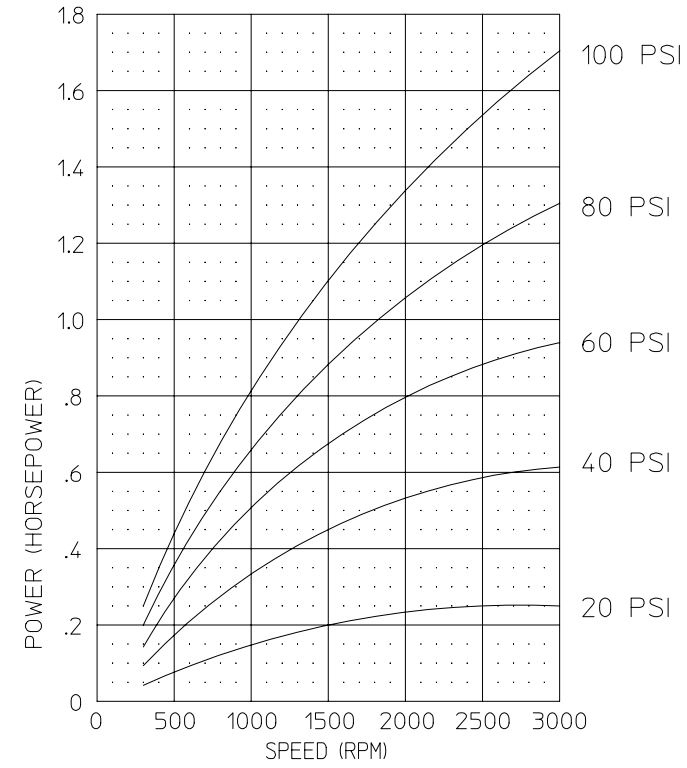
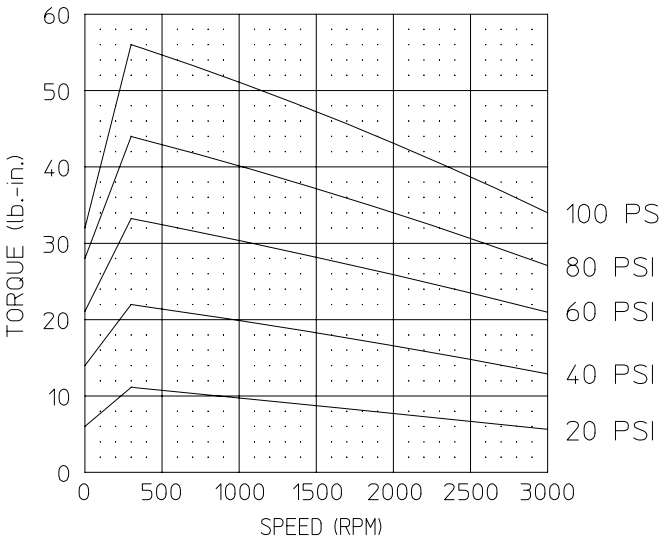
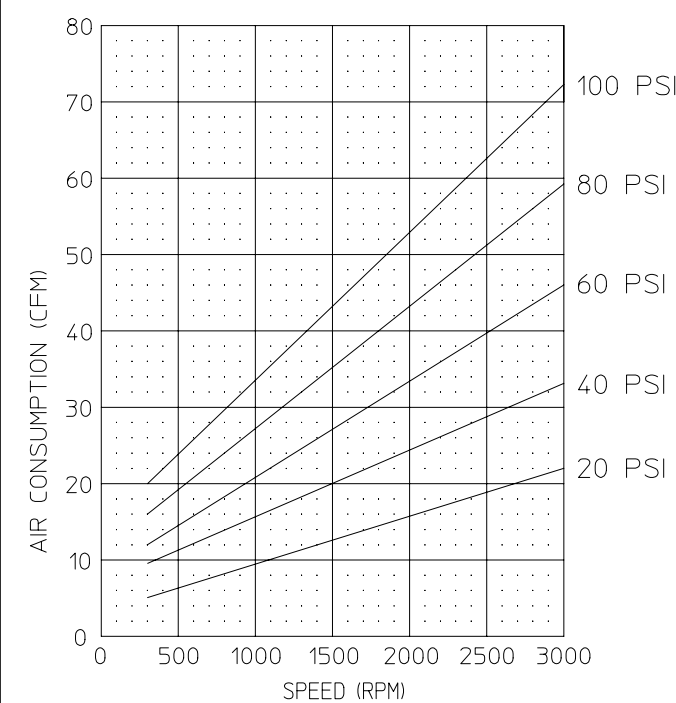
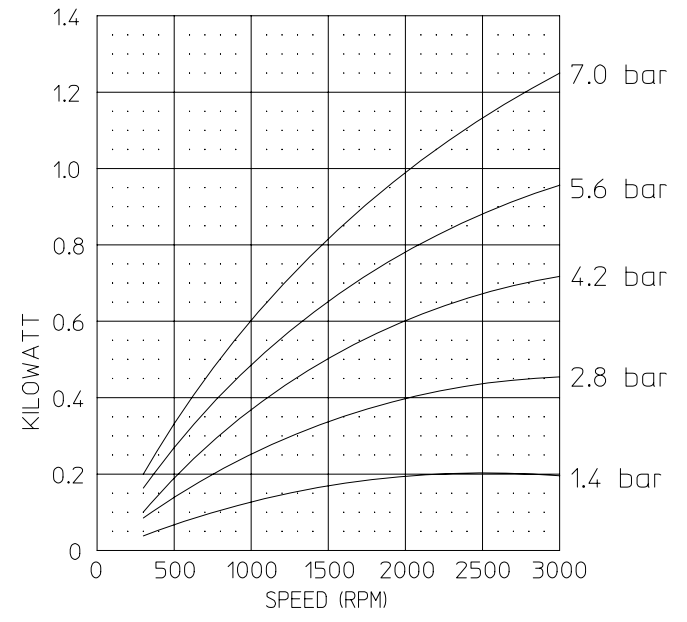
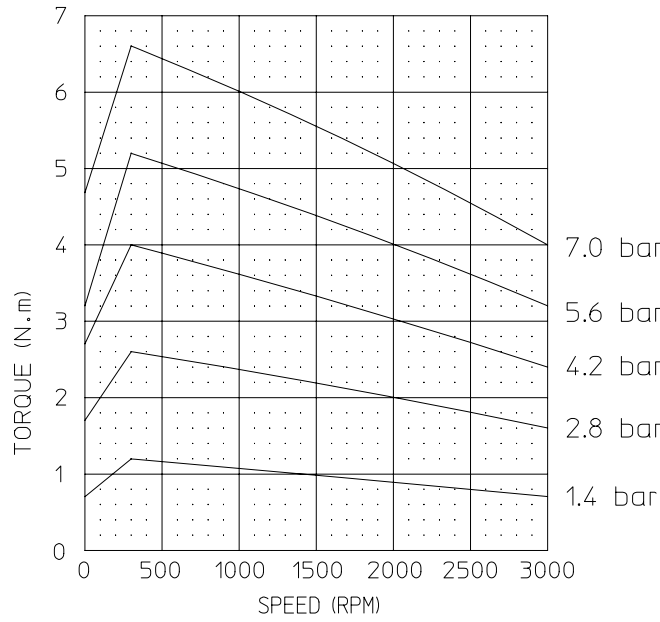
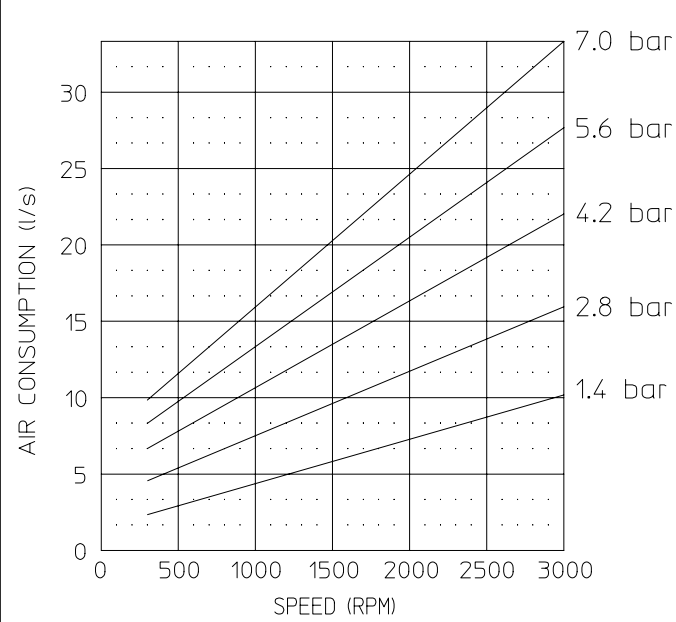

MUFFLER ASM.  
(SHIPPED UNATTACHED)

